

# RADIO NEWS

REG. U.S. PAT. OFF.

25 Cents  
March  
1923

Over 200 Illustrations

Edited by H. GERNSBACK

## NEW DEVELOPMENTS IN RADIO HORNS

*See Page 1612*

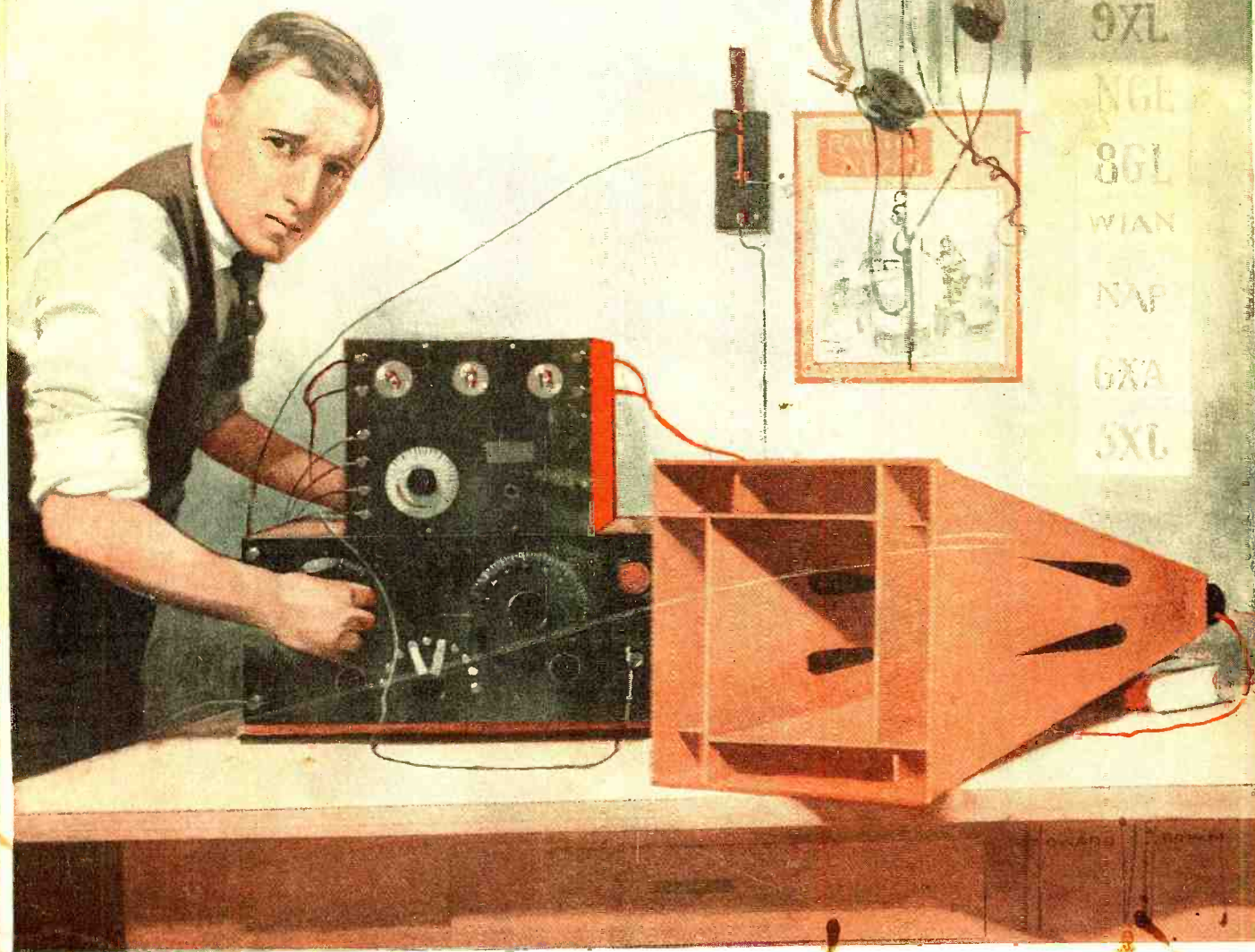

THE 100% WIRELESS MAGAZINE

CIRCULATION LARGER THAN ANY OTHER RADIO PUBLICATION

# Announcing the New Cunningham Amplifier Tube

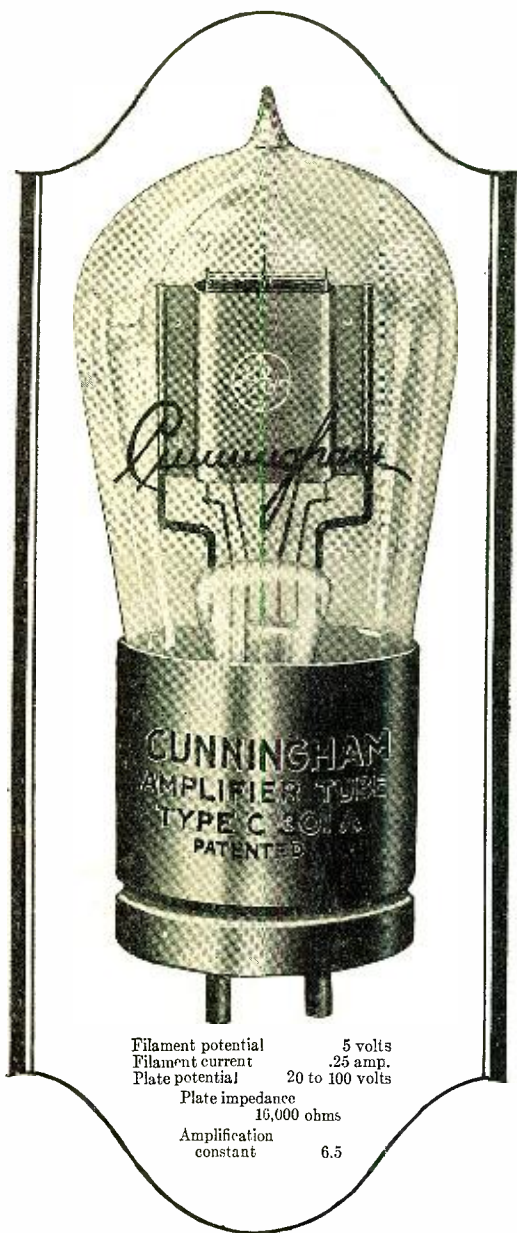

Type C-301-A      List Price \$9.00

The most efficient vacuum tube ever placed on the market for amateur and experimental use. The engineers of the General Electric research laboratories have at last succeeded in perfecting a tube that every owner of a radio set has been waiting for.

## Greater Power Amplification Only $\frac{1}{4}$ Amp. Filament Current

**T**HIS new and improved Cunningham C-301-A Amplifier is a high vacuum tube designed for use as an amplifier and detector, containing a new Tungsten Filament, the characteristics of which are long life, low power consumption, low operating temperature and greater power amplification than any previous amplifier tube. The tube has a standard four prong base, and the glass bulb has the same dimensions as the C-300 and the C-301.

The greatly reduced filament current permits the use of four of these tubes without exhausting the A battery any faster than when using one of the previous type of amplifier tubes.

Complete instructions for the care and efficient operation of this new Amplifier Tube are packed with every tube.

Insert a C-301-A in your amplifier set today. Note the improved quality and increased audibility.

*The Cunningham Technical Bureau is at your Service. Address your problems to Dept. R*

248 First Street  
San Francisco, California

154 W. Lake Street  
Chicago, Illinois

# Small Current—Big Job!

## Care in Selecting Your "B" Battery Cures a Whole Flock of Static Troubles

**A** LOT of radio bugs are missing a good bet when they fail to give the proper attention to the "B" Battery that supplies current to the plate circuit of the vacuum tube. In a good many cases—and this applies to the seasoned enthusiast as well as the newest novice in the ranks—it is wrongly set down that since this current is so exceedingly small it cannot be very important.

Nothing could more completely misrepresent the facts. True enough, the current supplied by the "B" Battery to the plate circuit is small—but it is precisely for that reason that even the slightest variations or disturbances are to be so carefully avoided.

In thinking of "B" batteries keep this in mind: The current from these batteries goes directly into the fine windings of the coils of your phones. Therefore even the slightest disturbance or unbalancing of the battery is translated directly into *noise*.

Obviously the reason for carefully soldered connections, loop aerials, short leads and the elimination of useless wires is to do away with *noise* just as far as possible. The same reason should dictate the careful selection of "B" batteries. It hardly pays to go to a great deal of trouble in taking the usual steps to eliminate static unless you also pick out a battery that is free from the hissing, sputtering and frying noises that are so often confused with static and that in common with static noises are multiplied six or seven times with each stage of amplification.

A "B" battery that is completely in accord with the efforts of manufacturers of sets to do away with static disturbances is known as the Willard "B" Battery. This battery consists of a group of twelve glass-jar cells, assembled in oak cases and connected with heavy burned-on connectors. Due to the distance between jars, electrical leakage from one jar to the next is practically impossible. As each of the cells has Willard Threaded Rubber Insulation between the plates there is no opportunity for leakage from plate to plate.

It is said by those who have carefully examined the construction of the Willard Radio "B" Battery that, in addition to its ability to give results without distracting noises, it will last—if not a lifetime—at least such a long period that it will show a material money saving long before it begins to exhibit even the slightest sign of age.

Willard Storage Battery Co., Cleveland, O.

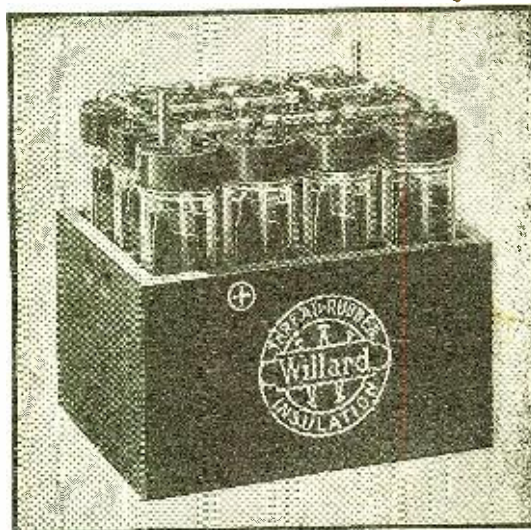

The Willard Radio "B" Battery is a 24-volt rechargeable battery. Glass jars—Threaded Rubber Insulation—screwed-on covers.



The Willard 6-volt, All-Rubber Radio "A" Battery has one-piece rubber case—Threaded Rubber Insulation—special Radio plates



The new Willard lower priced Radio "A" Battery (Type FW)—Willard-quality plates—selected wood separators—tested rubber jars, specially-designed terminals.

# RADIO NEWS



## CONTENTS

VOL. 4

FOR MARCH

No. 9

	Page		Page
Editorial.....By H. Gernsback	1611	The Principles and Construction of an Electrolytic Rectifier....By Kenneth M. Swezey	1643
New Developments in Loud Speaker Horns....	1612	The Meter Bridge: Its Construction and Use..	1644
Broadcasting Over Light Lines Prevents Interference .....	1613	An Attachment for Converting a Standard Morse Key Into a Side-Motion Key	
A Wireless Selective Call		By John M. Avery	1645
By Dr. Alfred Gradenwitz	1613	An Improvement.....By B. Bartzoff	1645
Electrons, Electric Waves and Wireless Telephony.....By Dr. J. A. Fleming.	1614	A Specially Designed Broadcast Receiver	
Experiments with the Two Plate Condenser Antenna.....By John C. Warner	1618	By Fred A. Burgess	1646
Interference.....By J. R. Tannehill	1620	An Easily Constructed Variometer	
Results of the \$500.00 Prize Contest.....	1621	By David A. Glushak	1647
A New Non-Interfering Detector Tube.....	1622	New Points for the Super-Sensitive Receiver	
The Radio Flivver.....By Stanley Edgar	1624	By E. H. Lerchen	1647
A "B" Battery Fuse....By A. W. Lambert, Jr.	1625	With the Amateurs.....	1648
Form a Radio Club....By Charles A. Reberger	1626	Calls Heard .....	1649
Broadcast Receiving and Receivers		Report of DX From Australia	
By John F. Bront	1627	By R. Slade and J. Lough	1650
Controlling Models by Radio		Some Experiments With Condenser Aerials..	1650
By Major Raymond Phillips	1628	Notes on the WD-11 Tube.....	1651
Radio Digest .....	1631	Points on Loud Speaker Operation	
A Bulb Receiver Using Rectified Alternating Current .....	1632	By J. E. Frisbee	1651
The New York Radio Show .....	1632	What France Received During the Trans-Atlantic Tests.....By Pierre Louis	1652
The Future of Commercial Radio		Meters for That C.W. Set..By J. F. Zweighaft	1652
By C. A. Reberger	1634	Measuring the Capacity of an Aerial	
At a Radio Party.....By Ring W. Lardner	1635	By J. E. Anderson	1653
Mr. Bimberry Hears the Banquet		The Pacific Coast Plan .....	1653
By Ellis Parker Butler	1637	Awards of the \$50 Radio Wrinkle Contest....	1654
Borrowing an Aerial.....	1638	Correspondence From Readers.....	1657
Tunes, Sounds and Slogans Are Becoming Popular .....	1639	Radio News Laboratories.....	1658
A Selective Multi-Range Regenerative Receiver.....By Kenneth Harkness	1640	Radio Humor .....	1660
Pointers in Operating Vacuum Tubes		New Radio Patents.....	1661
By M. Wolf	1641	An Experience.....By Edwin H. Glause	1662
The Construction of a Loop Aerial		New Schedules of Weather Reports Broadcast From NAT	
By D. R. Clemons	1642	I-Want-To-Know	1663
Index to Advertisers.....	1604		

RADIO NEWS is published on the 25th of each month. There are 12 numbers per year. Subscription price is \$2.50 a year in U. S. and possessions. Canada and foreign countries, \$3.00 a year. U. S. coin as well as U. S. Stamps accepted (no foreign coins or stamps). Single copies, 25 cents each. A sample copy will be sent gratis on request. Checks and money orders should be drawn to order of EXPERIMENTER PUBLISHING CO., INC. If you should change your address notify us promptly, in order that copies be not miscarried or lost. No copies sent after expiration.

All communications and contributions to this journal should be addressed to Editor, RADIO NEWS, 53 Park Place, New York, N. Y.; or 53 Park Place, New York, N. Y. Unaccepted contributions cannot be returned unless full postage has been included. All accepted contributions

General Advertising Dept., 53 Park Place, New York City. Western Advertising Representatives, Finucan & McClure, 720 Cass Street, Chicago, Ill. Kansas City Representative, Geo. F. Dillon, Republic Bldg., Kansas City, Mo. Pacific Coast Advertising Representatives, A. J. Norris Hill Co., Hearst Bldg., San Francisco, Cal.

Published by EXPERIMENTER PUBLISHING CO., INC., Publishers of "Radio News," "Science and Invention" and "Practical Electrician."

Publication Office: Jamaica, N. Y. Editorial and General Offices: 53 Park Place, New York City  
H. GERNSBACK, President S. GERNSBACK, Treasurer R. W. DEMOTT, Secretary

are paid for on publication. A special rate is paid for novel experiments; good photographs accompanying them are highly desirable.

RADIO NEWS Monthly. Entered as second-class matter at the Post Office at Jamaica, N. Y., under the act of March 3, 1897. Title registered U. S. Patent Office. Copyright, 1921, by E. P. Co., Inc., New York. The Experimenter Publishing Co., 53 Park Place, N. Y. The Contents of this magazine are copyrighted and must not be reproduced without giving full credit to the publication.

RADIO NEWS is for sale at all newsstands in the United States and Canada; also at The International News Co., Ltd., Bream's Building, London E. C. 4, England, and at Brentano's 37 Avenue de l'Opera, Paris.

When happiness or calamity is about to come,"  
said Confucius, "it can be known  
beforehand." Insure complete  
radio happiness with

# Grebe Receiver

*Doctor Mu*

**I**F YOU buy inferior radio apparatus  
you must not expect the best  
results.

Its long record of satisfactory serv-  
ice has won for the Grebe Receiver  
the unqualified endorsement of all  
experienced radioists and dealers.

Your copy of "Musings of Doctor  
Mu" sent free upon request.

**A. H. GREBE & CO., Inc.**  
RICHMOND HILL, N. Y.



Licensed under  
Armstrong U. S.  
Pat. No. 1113149

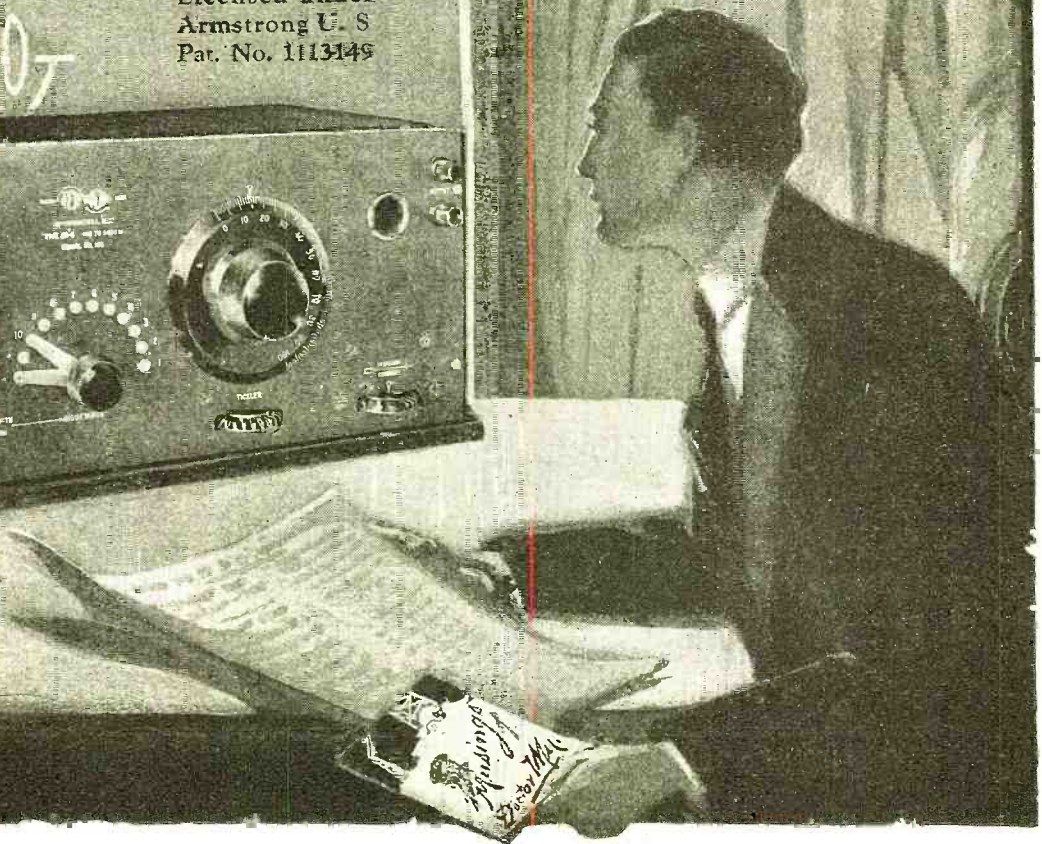
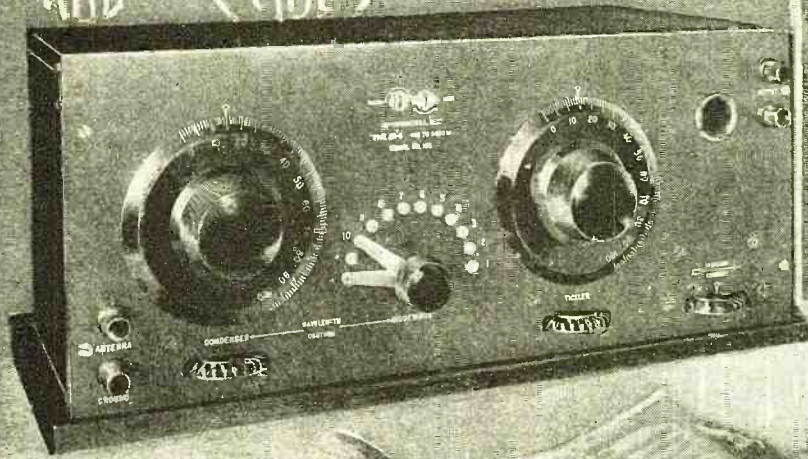

# Index to Advertisers

A	Page
Acme Apparatus Co., The.....	1713
Adams-Morgan Company.....	1693
Airway Electric Appliance Corp., 1734	
Atken Radio Company.....	1674
Ala Mfg. Company.....	1722
Alden Napier Company.....	1755
Allen-Bradley Company.....	1685
Alter & Company, Harry.....	1740
American Electric Company.....	1746
American Hard Rubber Com- pany.....	1715
American Radio Mfg. Co.....	1746
American Time Clock Repair & Supply Co.....	1750
American Transformer Co.....	1714
Amsterdam Service Exchange.....	1708
Andrea & Sons Co., Julius.....	1744
Andrea, Frank, A. D.....	1738
Angiers, U. S. A.....	1744
Apex Radio Company.....	1702
Atlantic-Pacific Radio Supplies Co.....	1701
Atlas Radio Company.....	1743
Atwater Kent Mfg. Company.....	1711
Audiotron Sales Company ..... Inside Front Cover	
Automatic Electrical Devices Co., The.....	1724
Autoyre Company, The.....	1736
<b>B</b>	
Baehm Paper Co.....	1742
Barawick Company, The.....	1690-1691
Barkeley Electric Mfg. Co., The .....	1681
Belden Mfg. Company.....	1734
Bell Mfg. Company.....	1684
Bogue, B. N.....	1750
Brach Mfg. Company, L. S.....	1718
Brandes, Inc., C.....	1751
Briggs & Stratton Company.....	1676
Bright Star Battery Co.....	1753
Broadway Electrical Novelty House.....	1722
Bunnell & Co., J. H.....	1751
<b>C</b>	
Carter Radio Company.....	1739
Central Radio Laboratories .....	1730
Chaslyn Company, The.....	1742
Chelsea Radio Company.....	1704
Chemical Institute of New York, Inc.....	1570-1605
Cherpeck Co., C. S.....	1718
Chicago Engineering Works.....	1742
Chicago Radio Apparatus Com- pany, Inc.....	1732
Choraleon Phonograph & Radio Co.....	1751
Clapp Eastham Company.....	1667
Clarke Coin Company.....	1750
Clearstone Radio Company.....	1700
Comer Mfg. Co.....	1744
Connecticut Tel. & Elec. Co.....	1749
Consolidated Radio Call Book Co.....	1692-1725
Continental Fibre Co., The.....	1703
Copper & Brass Research Ass'n.....	1742
Coto Coil Company.....	1708
Coyne Trade & Engineering Schools.....	1750
Crosley Mfg. Company.....	1606-1607
Cutler-Hammer Mfg. Co.....	1709
Cut Rate Radio Company.....	1732
<b>D</b>	
D-X Radio Company.....	1705
DeForest Radio Tel. & Tel. Co. .....	1697
Delfelco Battery Corp.....	1740
Demaree, C. S.....	1750
Diamond State Fibre Co.....	1679
Dictograph Products Corp., The.....	1710

E	Page
Dodge, C. K.....	1737
Dodge's Institute.....	1750
Donnell Mfg. Co., L. H.....	1731
Douglas Shoe Company, W. L. .....	1752
Dreyfuss Co., Inc., P. M.....	1704
Dubilier Condenser & Radio Corp.....	1730
<b>E</b>	
E. I. Company ..Inside Back Cover	
Economic Appliance Company.....	1741
Eiseman Magneto Corp.....	1746
Elco Radio Company.....	1733
Electric Service Engineering Co.....	1730
Electric Specialty Co.....	1700
Electrical Research Laborator- ies.....	1735
Electro Importing Company.....	1728
Elwood Electric Co., Inc.....	1696
Engravers & Printers Machin- ery Co.....	1700
Ernest Electric Company.....	1744
Evans & Co., Victor J.....	1754
Experimenter's Information Service.....	1723
<b>F</b>	
F. R. S. Radio Corporation.....	1676
Fedders Mfg. Company, Inc.....	1721
Federal Tel. & Tel. Co.....	1719
Ferbend Electric Co.....	1740
Finch Radio Mfg. Company.....	1676
Formica Insulation Co., The.....	1699
France Mfg. Company, The.....	1722
Freshman Company, Inc., Chas. .....	1734-1742
Frost, Inc., Herbert H.....	1729
<b>G</b>	
Galena Crystal Mfg. Co.....	1730
Gehman & Weinert.....	1732
General Electric Company.....	1733
General Radio Company.....	1708
General Radio Corp., The.....	1746
Gibbons-Dustin Radio Mfg. Co. .....	1676
Goodell-Pratt Company.....	1750
Goodman, L. W.....	1743
Gould Storage Battery Co.....	1736
Great Lakes Radio Company.....	1671
Grebe & Co., Inc., A. H.....	1603
<b>H</b>	
Handy Radio Company, The.....	1744
Harris Laboratory, The.....	1744
Hayden Radio & Research Co., A. C.....	1738
Hayes & Newton.....	1694
Hygrade Electrical Novelty Co. .....	1732
<b>I</b>	
International Insulating Corp.....	1702
Izenstark Radio Co.....	1720
<b>J</b>	
Jackson & Co., J. L.....	1750
Jefferson Electric Mfg. Co.....	1736
Johnson, G. F.....	1682
<b>K</b>	
K Electric Company.....	1735
Kellogg Switchboard & Supply Co.....	1717
Kensington Radio Supply.....	1720
Killoch Company, David.....	1716
Kimley Electric Company.....	1730
King Am-Pli-Tone.....	1688
Klosner Improved Apparatus Co.....	1672
<b>L</b>	
Lancaster & Allwine.....	1754
LeFax, Inc.....	1680
Leich Electric Co.....	1714

Lewis & DeRoy Radio Corp.	Page
Lewis & DeRoy Radio Corp.....	1704
Liberty Radio Co.....	1678
<b>Mc</b>	
McKenzie Engineering Co.....	1724
<b>M</b>	
M. P. M. Sales Co.....	1720
Magnavox Company, The.....	1675
Magno Storage Battery Co.....	1676
Manhattan Electrical Supply Co., Inc.....	1687
Marko Storage Battery Co.....	1700
Marshall Gerken Co., The.....	1676
Martin-Copeland Co.....	1673
Mass. Radio & Telegraph School, Inc.....	1736
Massey Radio Company.....	1736
Metal Arts Company, Inc.....	1750
Metric Metal Works.....	1710
Michigan Radio Co.....	1734
Michigan Radio Corp.....	1741
Michigan State Auto School.....	1750
Midwest Radio Company.....	1688
Mitchell & Company, R.....	1706
Montgomery Ward & Co.....	1686
Montrose Mfg. Co.....	1704
Mu-Rad Laboratories, Inc.....	1747
Murdock Company, Wm. J.....	1665
<b>N</b>	
National Airphone Corp.....	1695
National Radio Institute.....	1683
National Radio Products Corp.....	1716
National Vulcanized Fibre Co., .....	1748
New Haven Radio Company.....	1734
Newman Stern Company.....	1712
New York Coil Co., Inc.....	1753
North American Radio & Sup- ply Corp.....	1674
Northern Industrial Chemical Co.....	1749
Novo Mfg. Co.....	1738
<b>O</b>	
Omnigraph Mfg. Co., The.....	1678
Owen, Richard B.....	1754
Ozburn-Abston Radio Co., Inc.....	1680
<b>P</b>	
Pacent Electric Co.....	1677
Parker, C. L.....	1752
Philadelphia Storage Battery Co.....	1669
Picard Radio Corporation.....	1748
Pignolet Instrument Co.....	1745
Pioneer Radiophone Corp.....	1720
Pitts Company, F. D.....	1723
Pittsburgh Radio & Appliance Co., Inc.....	1688
Pittsfield Machine & Tool Co.....	1666
<b>R</b>	
Radiall Company.....	1732
Radio Consultation Bureau.....	1745
Radio Corporation of America, Back Cover	
Radio-Craft Company.....	1697
Radio Cut Price Co.....	1738
Radio Directory & Publishing Co.....	1746
Radio Distributing Co., The.....	1742
Radio Equipment Co.....	1682
Radio Experimenters League.....	1732
Radiogem Corporation, The.....	1721
Radio Guild, Inc., The.....	1689
Radio Industries Corp.....	1726-1727
Radio Institute of America.....	1730
Radio Instrument Co.....	1719
Radio Instrument & Panel Company.....	1712
Radio Parts Mfg. Co.....	1747
Radiophone Equipment Co.....	1706
Radio Research Guild.....	1744
Radio Service & Mfg. Co.....	1718
Radio Shop of Newark, The.....	1710
Radio Specialty Co.....	1610

Radio Stores Corp.	Page
Radio Stores Corp.....	1729
Radio Testing Station.....	1734
Randolph & Co.....	1752
Rasla Sales Corporation.....	1740
Rauland Mfg. Co.....	1717
Regal Typewriter Co., Inc.....	1752
Remler Radio Mfg. Co.....	1739
Reynolds Radio Co.....	1740
Rhamstine, J. Thos.....	1732
Ridgewood Radio Shop, The.....	1676
Rieger Research Corp.....	1668
Rose Radio Supply.....	1729
Rusonite Products Corp.....	1710
<b>S</b>	
Sadler Mfg. Co.....	1718
Saturn Mfg. & Sales Co., Inc., The.....	1686
Scholes Radio & Mfg. Corp., The.....	1748
Schweitzer & Conrad, Inc.....	1740
Signal Electric Mfg. Co.....	1734
Signal Radio & Electric Corp.....	1704
Sinclair, Mr.....	1750
Smith & Heminway Co., Inc.....	1750
Southern Toy Co., The.....	1684
Spaulding & Sons Co., Inc., J.....	1708
Springfield Wire & Tinsel Co.....	1702
Standard Metal Mfg. Co.....	1755
Standard Radio & Electric Co.....	1707
Star Mfg. Co.....	1714
Steinmetz Wireless Mfg. Co.....	1706
Stover Mfg. & Engine Co.....	1734
Stromberg-Carlson Tel. Mfg. Co.....	1670
Superamplifier Co.....	1734
<b>T</b>	
Telephone Maintenance Co.....	1698
Thornton Transformer Co., Inc. .....	1749
Timmons, J. S.....	1716
Topping & Co.....	1742
Trade Circular Addressing Co., .....	1752
Trimm Radio Mfg. Co.....	1744
True Tone Radio Mfg. Co.....	1712
Tuska Co., The C. D.....	1755
Twentieth Century Radio Co.....	1738
<b>U</b>	
Union Construction Corp.....	1745
United Mfg. & Distributing Co.....	1712
Universal Radio & Research Co.....	1706
Universal Sales Co.....	1674
<b>V</b>	
V-De-Co Radio Mfg. Co.....	1742
Valley Electric Co.....	1746
Vesco Radio Shop.....	1736
Vesta Battery Corp.....	1702
<b>W</b>	
W. E. Supply & Service Corp.....	1736
Walbert Mfg. Co.....	1724
Ware Radio Corp.....	1743
Waveland Radio Company, Inc.....	1744
Webster Electric Company.....	1737
Westinghouse Union Battery Co.....	1731
Weston Electrical Instrument Co.....	1696
Wicks Electrical Institute.....	1750
Willard Storage Battery Co.....	1601
Wilmington Fibre Specialty Co., .....	1746
Wilson Utensil Company, The.....	1694
Wireless Mfg. Co., The.....	1698
Wireless Shop, The.....	1747
Workrite Mfg. Co., The.....	1608-1609
World Battery Co.....	1722
<b>Y</b>	
Y. M. C. A. Radio School.....	1746

# When the Chemist Harnessed the Thunder-bolt!

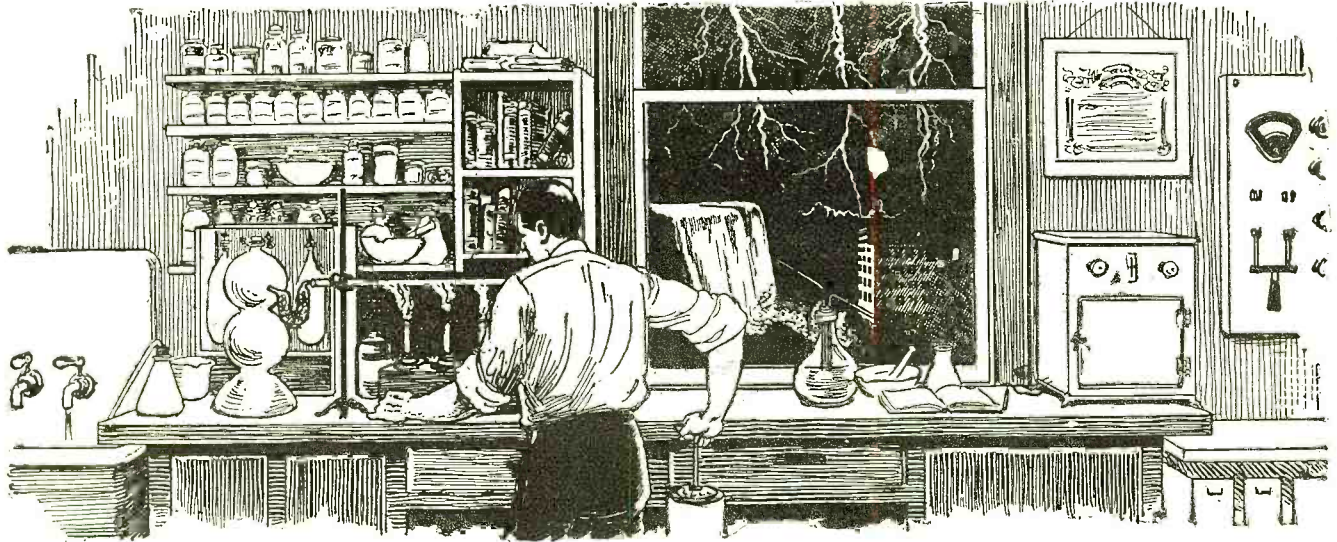

**M**AN and beast react with electric speed to a warning of danger, if the alarm is immediate and personal. Self-preservation is the first law of Nature. Yet subtle perils far more disastrous than any we expect to meet lurk in the shadow of our fancied security. They are the dreaded ogres of Famine and Disease.

A few years ago the world faced a famine more terrible than any in history. Nitrates, the most essential materials for enriching the soil, were being rapidly exhausted, and universal starvation seemed inevitable. Everyone knows that plants must feed, and if the ground is not replenished with the chemicals they have consumed, vegetation will eventually die out. Nature's way of making up the deficit is too slow for our concentrated population, and farmers have resorted to artificial fertilizers for ages. Europeans, always more receptive to the teachings of Chemistry than we, raise more than twice as much grain per acre as Americans, owing to their greater use of fertilizing chemicals.

The principal substance used for this purpose is sodium nitrate, better known as Chile saltpetre, because of the large deposits of it in that country. Millions of tons of this precious chemical were being mined annually, for vast quantities are consumed in making explosives and in other industries, besides that required for agriculture. Chile kept getting richer, but her nitrate beds got continually poorer until their inevitable exhaustion became a grisly prospect. *And there was no other source of supply!*

It was here that electro-chemists stepped in and devised a way of making nitrates from the air! They stole a trick from Nature, using an artificial bolt of lightning, the electric arc, to change the nitrogen and oxygen into nitric acid. This is indeed what happens during a thunder-storm, though to a very slight extent. Other methods followed, and thanks to Chemistry the air-made nitrates can now be sold for less than the saltpetre of Chile. Better still, the supply is unlimited.

Today we are confronted with similar crises. There are impending shortages of other important raw materials. Yet so great is the general confidence in chemistry to solve such problems, little anxiety is felt. A wealth of opportunity awaits the chemist of the present, particularly in the fascinating field of Electro-chemistry. In many industries there are hundreds of chemists employed by a single company. Thousands of concerns have chemists supervising the quality of their output and of the materials they buy. In countless capacities a knowledge of Chemistry is essential.

## You Can Learn Chemistry at Home Dr. T. O'Connor Sloane Will Teach You

Dr. Sloane, Educational Director of the Chemical Institute of New York, is one of this country's foremost authorities on chemistry. He was formerly Treasurer of the American Chemical Society and is a practical chemist with many well-known achievements to his credit. Not only has Dr. Sloane taught chemistry for years, but he was for a long while engaged in commercial chemistry work.

The Chemical Institute of New York was originally founded to fill a long-felt need in the Educational field. Thousands of young men and young women, realizing the wonderful opportunities for the chemist produced by the recent war and the assumption by the United States of world leadership, were keenly anxious to enter this promising field. Many of these prospective students, however, were unable to give up their regular occupations to devote the necessary time to their training. Correspondence study at home was the only solution.

Dr. Sloane will teach you Chemistry in a practical and intensely interesting way. Our home study course written by Dr. Sloane himself is thorough, logical and remarkably fascinating. It is illustrated by so many experiments that are performed right from the start that anyone, no matter how little education he may have, can thoroughly understand every lesson. Dr. Sloane teaches you in your own home with the same individual and painstaking care with which he has already taught thousands in the class room.

### The Personal Help of Dr. Sloane

Dr. Sloane will personally examine and correct all of your examination papers, pointing out your mistakes and correcting them for you. He will, in addition, give you any individual help you might need in your studies. This personal training will be of inestimable value to you in your future career.

### Easy Monthly Payments

You can pay in small monthly amounts as you go along. The price of our course is very reasonable, and includes everything. There are no textbooks to buy extra, and the chemicals and apparatus used for experiments are supplied to the student *without additional charge*. Our plan places an education in chemistry within the reach of everyone.

### Experimental Equipment

**Given to Every Student Without Additional Charge**

We prepay even the shipping charges on the outfit. It comprises 42 pieces of apparatus and 17 chemicals and reagents. The fitted, heavy wooden case serves not only as a carrying case, but also as a laboratory accessory for performing experiments.

### Special 30-Day Offer

For a short period we are making a special offer that will be worth your while to take advantage of. Write for our free book, using the coupon below or simply a postal card. This will not obligate you in the least. Do not wait until tomorrow. Send the coupon now while you think of it, and let us tell you our story.



CHEMICAL INSTITUTE OF NEW YORK, Inc.  
Home Extension Division 3  
140-R Liberty St., New York City.

Please send me at once without any obligation on my part, your free Book "Opportunities for Chemists," and full particulars about the Experimental Equipment furnished to every student. Also please tell me about your plan of payment and your special 30 day offer.

NAME.....  
ADDRESS.....  
CITY.....  
STATE.....  
R.N., 3-23.

**Chemical Institute of New York, Inc.**  
Home Extension Division 3  
140-R Liberty Street, New York City

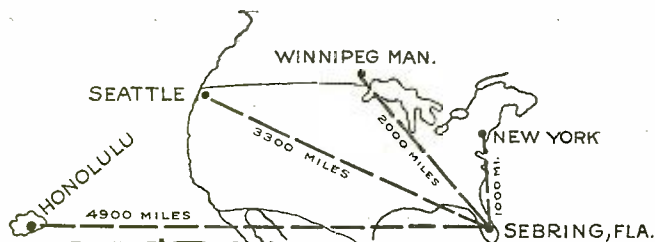

# For DISTANCE HERE is a RECORD

The remarkable results achieved with Crosley Radio Instruments are equaled only by their exceptionally low cost. A man in Sebring, Fla. listening in with a Crosley Model X—price only \$55 for this 4 tube set—writes: "We are receiving from all standard stations north, east and west—from Winnipeg, Can., New York City, Seattle, Wash., and one night received three selections and two announcements from KDYX at Honolulu."

The secret to Crosley efficiency as well as Crosley prices is our thorough knowledge of wireless applied practically to the quantity production of simplified receiving sets and parts.

A few of our models illustrated herewith give an idea of Crosley value.

### Crosley Receiver Model VI

A wonderful set at a wonderful price. Combines one stage of tuned radio frequency with a tuner and audion detector. Price, without bulbs, batteries or phones. . . . . \$28.00

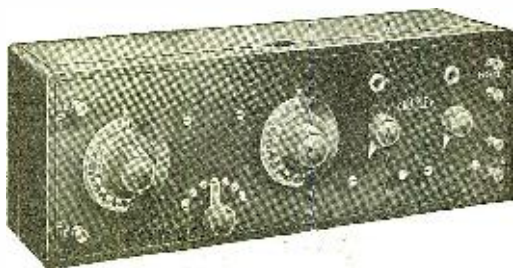

### Crosley Receiver Model X

The most complete receiving set on the market. A 4 tube set consisting of one stage of tuned radio frequency, detector, and two stages of audio frequency amplification. It was on this instrument that Sebring, Fla. heard Honolulu. Price, without batteries, tubes and phones \$55.00.

We also manufacture complete parts for those who wish to build their own outfits. Below are illustrated a few of these. Illustrated booklet entitled "How to Build Your Own Radio Set using Crosley Parts" will be sent upon receipt of 5c.

## CROSLEY MANUFACTURING CO.

CINCINNATI, OHIO

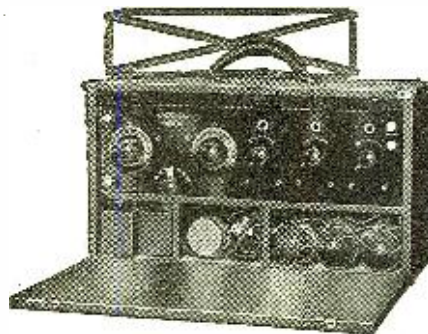

### Crosley Model VI Portable

A new departure for those desiring to carry receiving outfits with them. A 1½ volt tube set that eliminates necessity of expensive "A" battery. Consists of detector and one stage of tuned radio frequency amplification. Price, without batteries, tubes and phones . . . . . \$40.00



### Crosley Receiver Model VIII

A new set offering exceptional value. Contains one stage of tuned radio frequency amplification, detector and one stage of audio frequency amplification. Also offered as a portable instrument using 1½ volt tube. Price, without batteries, tubes and phones, Regular Model VIII \$48.00, Model VIII Portable \$60.00.

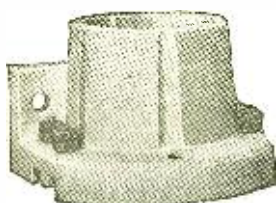
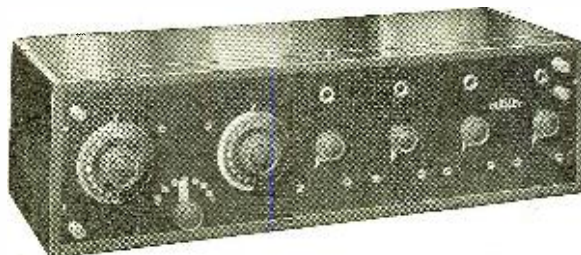

V-T Socket  
40c



Socket Adapter with bushings and screws  
70c. Without, 60c. Makes it possible to use 1½ volt tubes in Crosley Sets.



Rheostat 50c.

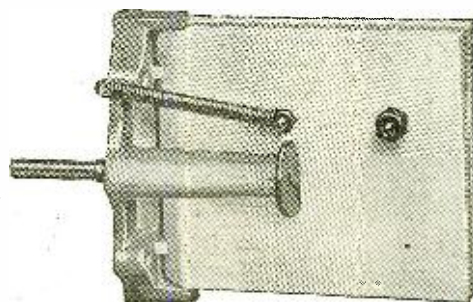

Crosley Condenser—Model C



# FOR BEAUTY

## Crosley Cabinet Models Are Incomparable

To bring the pleasures and usefulness of radio into the home and at the same time add a beautiful piece of furniture is the desire of many. To meet this desire Crosley Receiver Models XX and XXV have been evolved. Designed especially with an eye to beauty, these models nevertheless lose none of their efficiency. The cabinets are staunch in structure. All parts are easily accessible to the operator. Music received on either of the instruments will be clearly heard throughout a large room.

### CROSLEY RADIO APPARATUS

## Better Costs-Less

*Making distance  
records everywhere*

**View one of these models—then listen in on it.**

**You will immediately want one.**

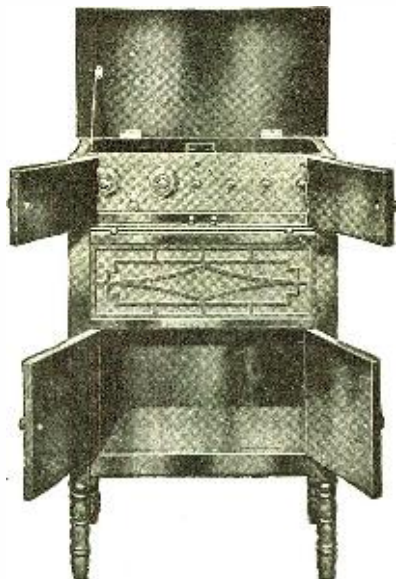

### Crosley Receiver Model XX

The last word in beauty and efficiency. Consists of Tuner, one stage of tuned Radio Frequency Amplification, Audion Detector and two stages of Audio Frequency Amplification. Easily tuned to true accuracy. One of these outfits with an indoor antennae filled the largest auditorium in Cincinnati with messages from Fort Worth, Texas, Schenectady, N. Y. and other distant points. A pamphlet more fully explaining the details of this marvelous instrument will be sent on request.

Price without tubes, batteries, phones and loud speaker  
**\$100.00**

### Crosley Receiver Model XXV

**A real addition to any room**

The receiving set itself is the same as Model X pictured on the opposite page. The cabinet is of extremely beautiful design and very strong. The lid is hinged and when raised allows easy accessibility to every part of the receiving apparatus. The upper and lower doors are also hinged. Directly below the receiver is a highly finished board that may be pulled out thus forming a desk for the person operating the instrument.

Price without tubes, batteries and phones ..... **\$150.00**



## CROSLEY MANUFACTURING CO.

ALFRED STREET

CINCINNATI, OHIO



### Crosley R. F. T. A.

This unit can be used with practically any type of audion detector outfit. It is a feature of all our larger units. The R. F. T. A. not only amplifies the signals before they reach the detector, enabling it to work more efficiently, but also makes sharper tuning possible and eliminates interference to a wonderful degree. Will add at least six times the volume and range.

Price without tube ..... **\$12.00**

# “WorkRite” CONCERTOLAS

THE BIG HIT IN LOUD SPEAKERS!

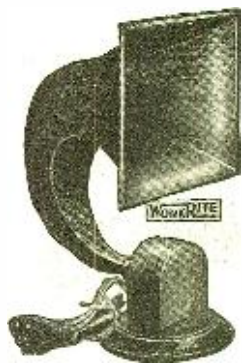

Jr. Concertola \$12.00

Let the whole family and friends enjoy the wonderful concerts, lectures, and other entertainment which is free for the taking. Attach a WorkRite Concertola to your set the same as a head phone. Requires no extra batteries. **WORKS ONLY ON TUBE SETS WITH TWO STEP AMPLIFICATION.** These loud speakers are different from others. There is no metal in them, which eliminates the tinny sounds of others. Reproduces voice or music in a clear, loud tone without distortion. Just right for home use. **BOTH THE CONCERTOLA SR. AND JR. COME COMPLETE WITH OUR SPECIAL PHONE UNIT AND CORD. ORDER NOW AND DOUBLE THE PLEASURE OF RADIO IN YOUR HOME.**

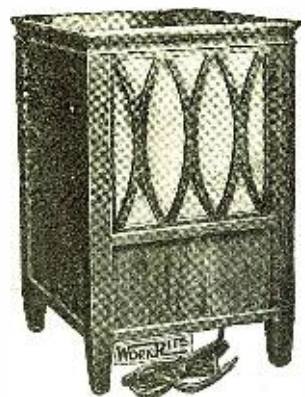

Sr. Concertola \$24.00

## FREE TRIAL!

Upon receipt of the price, you will be furnished with either the Junior or Senior, charges prepaid. If not found satisfactory, you may return it and your money will be refunded.

### WORKRITE Super Vernier RHEOSTAT

Here is a Rheostat with unlimited adjustments. Pushing the knob in or out gives quick adjustment. Turning the knob around gives the most minute adjustment. Often turning the knob 1/32" will clear up a concert or separate two stations. You must use a WorkRite Rheostat to realize how much more efficient it will make ANY set. Indispensable for the detector tube. Equip your set with a "WorkRite" and note the difference!

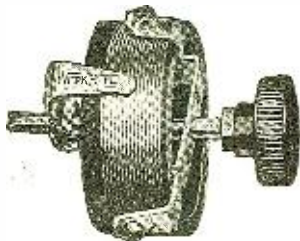

PRICE ..... \$1.50

### WORKRITE E-Z-TUNE DIAL

When you want to get very fine adjustment on your variometers, variocouplers, condensers, etc., you always grasp your dial on the outer edge for more leverage. Right there is where you will find a knurled flange that just fits your grasp on the WorkRite E-Z-Tune Dial. You can easily make a turn of a hair's breadth.

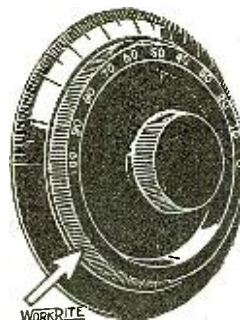

Made of the finest material, highly polished. Easily the "snappiest" dial on the market. 3 1/2" diameter. Specify whether 3-16" or 1/4" shaft.

PRICE ..... 75c

**“WorkRite Products WorkRite”** Do not accept any substitute. If your dealer does not handle them, send check and we will see that you get them promptly by mail prepaid.

**THE WORKRITE MFG. CO.**

5501 Euclid Ave., Cleveland, O., U. S. A.

( BRANCH OFFICE )  
2204 S. Michigan Ave.  
Chicago, Ill.

# “WorkRite” REDUCES PRICES

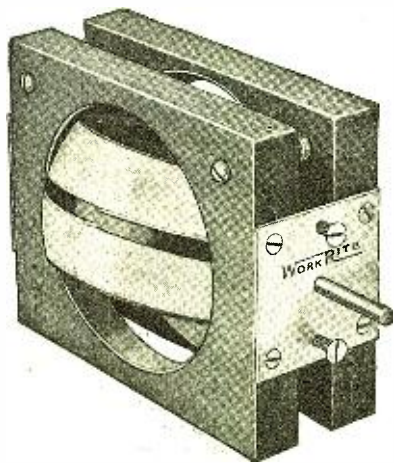

**WorkRite  
Super Variometer**

The “WorkRite” Variometer is made from the finest quality mahogany, oil rubbed—a beautiful instrument. Brass parts nicked. Sixty wire turns on stator and sixty on rotor. Rotor wound with green silk. No shellac used. A perfect Variometer both technically and mechanically.

**NOW**  
**\$3.50**  
**EACH**

*Last Spring  
they sold  
for \$6.00 each*

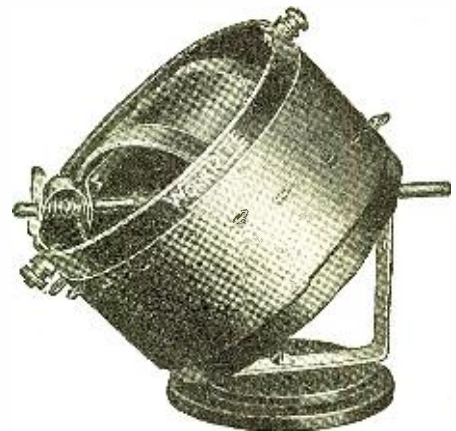

**WorkRite 180°  
Super Variocoupler**

The “WorkRite” Variocoupler is being used the world over because it represents the last word in a coupler. Tunes twice as sharp as the ordinary 90 degree coupler. Made from polished Formica. Sixty wire turns on primary, forty-five on secondary. Both wound with green silk. Twelve taps. Double springs at each connection. There is no better on the market at ANY price.

## THE FAMOUS “WORKRITE TUNER TEAM”

Two WorkRite Variometers and one WorkRite Variocoupler make a Tuner Team that cannot be beat for selectivity and long distance records. Concerts have been heard across the entire continent with them. Local concerts can be tuned out usually and long distance brought in.

PRICE: Due to our enormous production, we have been able to reduce prices gradually from \$6 each down to the present price of \$3.50. You have long wanted to build a high grade set with WorkRite Products—now is your chance at prices that will probably never be lower. Order yours now!

**THE WORKRITE MFG. CO.**

5501 Euclid Ave., Cleveland, O., U. S. A.

(BRANCH OFFICE  
2204 S. Michigan Ave.  
Chicago, Ill.)





# RADIO NEWS

H. GERNSBACK—Editor and Publisher  
ROBERT E. LACAULT—Associate Editor

EDITORIAL AND GENERAL OFFICES, 53 PARK PLACE, NEW YORK

Vol. 4

MARCH, 1923

No. 9

## Radio's Greatest Opportunity

THE great boom in Radio has come and gone. It came like a tidal wave, and left in its wake the customary amount of devastation. Now that the radio industry is recovering from the slump and is working hard to set its house in order, our best minds in the radio field are trying to find new channels for the radio trade. In some cases they are successful—in the majority of cases, the success is not so marked.

The first thing a radio manufacturer or dealer will do is to look for his trade in the big cities. He will secure all the directories where the radio trade is thickest and will push this territory for all it is worth. Salesmen galore are sent out into the large centers, and while they do not report zero sales as they did last summer, the sales that are being made at the present time, although fair, are far from satisfactory.

We have pointed out, before this, some of the fundamental reasons why the radio trade slumped. We have mentioned heretofore that what the radio industry needs most are goods that will stay sold and that will do the work. That, however, is only half the story.

In our December, 1922, issue, the writer called attention to the fact that at the present time about 60 per cent of the population has never even heard a radio concert. To people who live in the large centers this seems like a very curious statement, but it is nevertheless a fact. Draw a circle on a map with a radius of 25 miles around any broadcasting station, and within that circle, at the present time, is located an overwhelmingly large percentage of all the radio broadcast listeners. *Outside of this circle, Radio is practically not known.* If this statement is not taken as a big and evident truth, you may jump upon the next train and canvass the country yourself. You will be very much astonished.

Here are a few towns selected at random, which have been investigated, and which were canvassed carefully with these results:

"Waterford, Virginia. 40 miles from Washington, the nearest broadcasting center. Two radio outfits. Population 500.

"Canton, Pennsylvania. About 200 miles, air-line, from the Greater New York broadcasting district. Six radio outfits, only one of which was in operation, when investigator was there in October. Population 3,500.

"Addison, New York. About 125 miles from Buffalo. Two radio sets when investigator was there in October. Population about 2,000.

"Kayford, West Virginia, and other coal mining camps along Cabin Creek. Several thousand miners and a hundred or more well-paid officials. *Not a radio set in the region.* All interested, too, but nobody had been out there to sell them. About

20 miles from Charleston and possibly 200 from Louisville, Ky."

Here, then, are four towns, with a total population of about 8,000 inhabitants and with the magnificent total of 10 radio outfits! The percentage of outfits to the population, it will be seen, is microscopic. It is another case of one-half the world not knowing what the other half is doing. The conditions, as shown in these four towns, may be duplicated, *ad infinitum*, all over the country. In other words, as far as radio and the country are concerned, the surface has as yet not been scratched. There are literally millions of Americans all over the country who are waiting to be sold, and these same people go without their outfits simply because the radio industry lacks proper salesmanship to establish radio in the small towns and on the farms.

There are, today, few farm houses in rural districts that do not boast of their phonographs and their pianos. It is, indeed, a poor farm that does not have both. Now, if phonographs and pianos can be sold on a farm, why not radio outfits? Some day radio manufacturers will wake up to the fact that sending out salesmen into such territory will be like sending them into an open gold mine.

If the product is good, and if a demonstration can be given, a sale can be made in almost all cases. There is no district more anxious and willing to have radio outfits than the rural, for the simple reason that the small town inhabitant, or the farmer, can not come to the large city very frequently for his amusements. It is comparatively seldom that he sees a "movie" and much less frequently that he sees a good show. He does not hear good music, except on the phonograph, but with radio, the whole world comes right into his home. Once he has been introduced to a set there is hardly a greater radio enthusiast than the farmer or a small town citizen. Today, however, he is deprived of the benefits of radio simply because the radio industry as a whole is chasing butterflies in the large centers, instead of getting down to brass tacks and pushing sales where they are easiest and *most profitable*.

Nor is this all. Once a farmer has been sold an outfit, he, as a rule, will have become a customer for life, because he is not going to stop at his first radio outfit. He will soon need parts. He will also require tubes, new condensers, new coils, to reach out, and he will soon become a radio amateur who knows the code, and who must know the code to listen to the market reports that are transmitted in code.

There is no question that radio will have really arrived when the farming and rural districts have taken up radio in earnest, but we warn those who are starting out into this virgin field that *only first class goods will prove a success.* Anything that does not work—any outfit that has too many controls, and is made for experts only—will prove a boomerang to the manufacturer and to the entire industry.

H. GERNSBACK,

# New Developments in Loud Speaker Horns

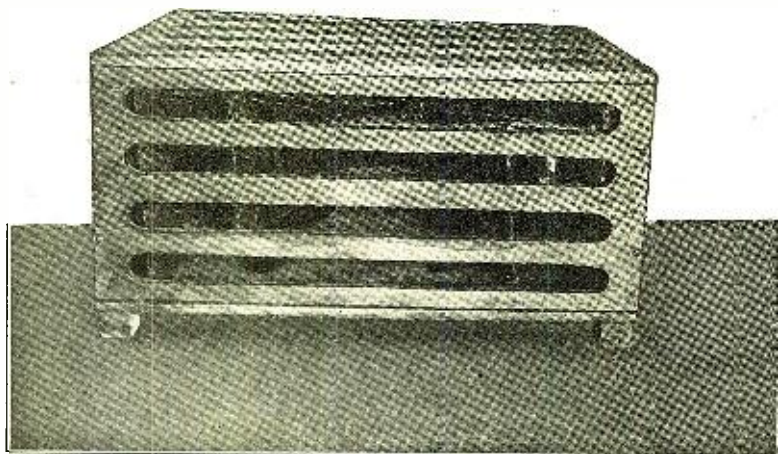

This Novel Horn, Designed To Be Used With a Loud Speaker Mechanism, Gives Remarkable Results. It Has Openings On All Faces and Has Partitions In Which Slots Are Cut to Prevent Them From Vibrating at Certain Frequencies, Thus Causing Distortion.

At a private demonstration given recently, we had the opportunity to compare the results obtained with these new horns and those obtained through the ordinary amplifying horns used on the present-day loudspeakers. Used on the phonograph, the horn designed by Mr. Blieberger amplifies the sound in a remarkable manner, giving to the listeners the impression that the singer is in the room and not at the end of a long hall as is the case with most of the phonographs. There is no blasting effect and the sound comes pure and clear in every direction as the horns have openings on every face. These new sound-amplifying devices certainly mark a step in the improvement of loudspeaking machines. Used with good loudspeaking mechanism and efficient amplifiers, they will help to attract more music-lovers to radio.

EVER since the phonograph was invented there has been a demand for a sound-reproducing device which would eliminate the distortion of voice and music caused by the ordinary horn.

The acoustical devices pictured on our front cover, and those illustrated on this page, are the invention of Mr. Charles Blieberger, who has spent the past 10 years in the study of acoustics and in the development of his system of natural sound amplification. The illustrations show only a few of the many models made up by Mr. Blieberger to test out his theories.

Mr. Blieberger is an expert musician with a highly trained musical ear. For a number of years he specialized in restoring and reconstructing old Master Cremona violins. It was because of his fine musical ear and his consequent dissatisfaction with the reproduction of music from phonographs, that led him to investigate the musical qualities of horns, and resulted in the perfection of his inventions.

His first idea was to conduct the sound from the tone-arm of a phonograph to a central sound receiving chamber, communicating with other sound developing and amplifying chambers opening to the outer air, the object being to allow the various musical sounds, with their harmonics to freely vibrate at their natural periods. The first experimental device was comparatively large, being five feet high and two feet square, containing a series of five major sound chambers, and a large number of smaller compartments. This device reproduced a very fine quality of music, the character of which could be compared with that of a pipe organ. The instrument reproduced many of the overtones or harmonics, which gave all musical instruments their characteristic timber. Results from the original instrument indicated that he was on the right track, and then followed many experiments to determine the best size and shape of the sound developing chambers and their inter-communicating passages. Finally, a technique was developed whereby devices may be designed to suit any type of sound reproducer of the phonograph, telephone, or loud speaker art.

Two patents had been issued to Mr. Blieberger, the first, covering the adaptation of the invention to devices for recording, reproducing, and amplifying sound, and particularly suitable to the phonograph art, and the second, covering device suitable for radio, telephone, and loud speaker sound amplification.

Many attempts have been made to improve the sound reproduction from phonographs and loud speakers, by the addition of so-called sympathetic resonators, such as sounding boards, musical strings, resonant tubes, wood and metal rods, etc. His instruments do not add sounds to those given by the

## NEW RADIO LEGISLATION WILL SOON BE IN EFFECT

By CARL BUTMAN

Radio manufacturers, organizations, operators and fans will be interested in H. R. 13773, the amended White Radio Bill re-

This Horn Is Made So That a Baldwin Phone or Other Similar Unit May Be Attached To It. It Has the Same Acoustic Properties As the Other Horns Designed by Mr. Blieberger, But Concentrates the Sound in a Certain Direction.

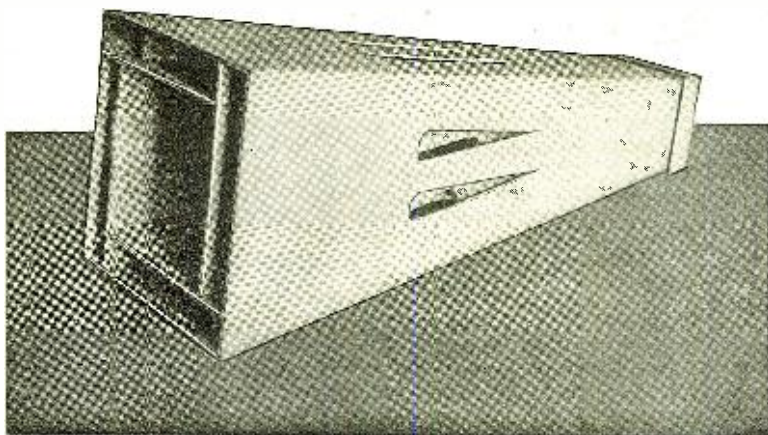

original vibrators of the diaphragm, such as the blare and chocky effects of the horn or megaphone, but on the contrary, the sound waves are developed and distributed in all directions, with the result that a perfectly natural amplified tone is produced.

Several commercial models have been designed and will soon be available for replacing the horns on existing phonographs and the present-day power loud speakers, also smaller types which will operate when connected with a higher grade head telephone.

ported out on the floor of the House by Chairman Green of the Merchant Marine Committee. As predicted, minor controversies were adjusted, ambiguities corrected and the bill was printed.

No opposition is expected in the House, where the bill will probably be taken up within a short time, it is said by members of the committee.

Secretary Hoover and Secretary Denby and their advisers have agreed to a compromise, and the Bill now carries a clause that Army and Naval Stations shall not require commercial licenses, that their wave-lengths will be assigned by the President, but that when commercial traffic is handled rules and regulations designed to prevent interference with other radio stations will be observed. In other words, Governmental stations when transmitting other than official matter will use commercial wavelengths and comply with all regulations set down by the Secretary of Commerce.

One feature of the Bill increases the membership of the Secretary of Commerce's advisory committee from twelve to fifteen, in-  
(Continued on page 1741)

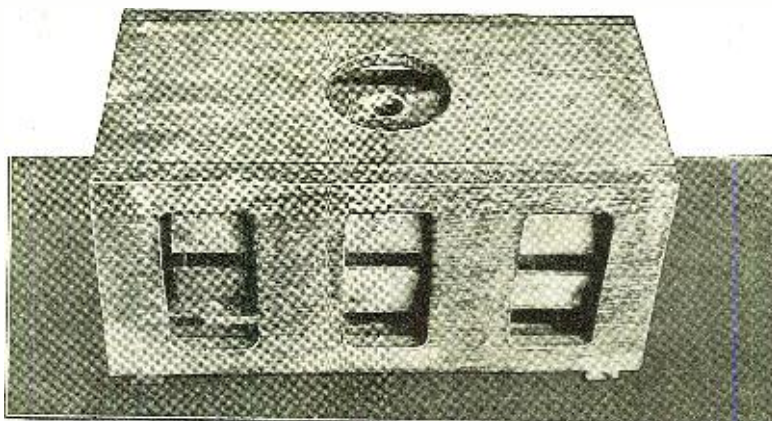

Back View of Another Acoustic Device, Which May Be Used As a Loud Speaker or Phonograph Horn.

# Broadcasting Over Light Lines Prevents Interference

RECENTLY, at the Bureau of Standards, R. D. Duncan, Radio Engineer for the North American Company, gave a practical exposition of "wired-wireless" broadcasting over the system of the Potomac Electric Light and Power Company. At a distant sub-station in Georgetown, an assistant "put on" informal entertainment through an ordinary broadcasting set over the 2500-volt alternating circuit. Through the maze of underground and overhead wires and cables the radio messages came into the Signal Corps Radio Laboratory at the Bureau from an electric light plug. The voice of the spokesman was picked up by a tube set coupled in with condensers. A 5,000-meter wave was used and the transmitting current was .05 ampere. There was no radiation. No other radio fans knew what was going on, but if they had, they could not have picked it up from the air—it wasn't in the air. Secretary Hoover will never have complaints of interference on this broadcasting scheme, as being confined to the electric wires; it leaves the air clear for long-distance broadcasting; it needs no wave assignment and neither the station nor operator will have to secure a license.

General Squier's patents for directed radio have been purchased by the North American Company of New York, which owns and operates electric lighting utilities in Cleveland, Milwaukee, St. Louis and several other cities, and this company plans to furnish its subscribers with wired-wireless entertainment in the near future. Mr. Duncan, radio engineer of the company, is

now completing the details of a standard installation and predicts the early use of the system in several cities. All subscribers will have to do is to consult their lighting companies, secure a good long-wave tube set, a condenser or special plug to protect their sets from the high potential circuit, and plug in just as they do with common electrical appliances.

General Squier's demonstration on a private lighting circuit of 110 volts direct current nine months ago, has now been applied to a regular city lighting system and works to perfection.

One great advantage of the system is that several programs may be broadcast on the line at various wave-lengths without producing interference with the others or with the radio broadcasts. Since no aerials are necessary with this system, little or no static interference is experienced.

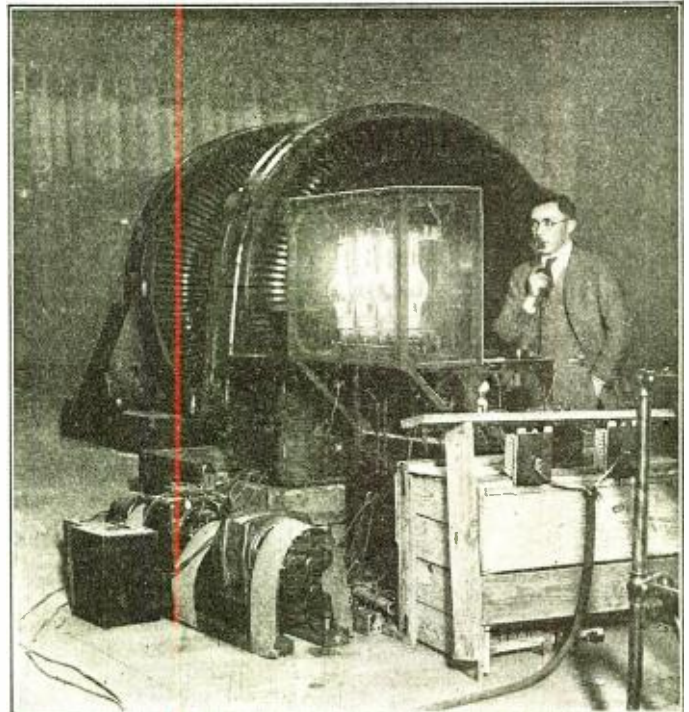

(c) Underwood & Underwood.

A View of the Wired Wireless Transmitter Recently Tested Out by the Bureau of Standards. The High Frequency Energy is Confined and Directed to Flow Along Definite Paths From the Transmitter to the Various Receivers.

## A Wireless Selective Call By DR. ALFRED GRADENWITZ Berlin Correspondent of RADIO NEWS

ONE of the most interesting problems that, since the inception of wireless telegraphy and telephony, have been facing the radio engineer is the designing of some wireless call similar to the automatic selectors used in wired telephony. There are mainly three important applications of the art which would seem to be called upon to profit by such a scheme, viz, first, wireless alarms on board ship to be used in cases of distress to send out an appeal for help to vessels passing in the neighborhood, second, radio-telephony on the "wired-wireless" system along high tension conductor lines between power houses and their several sub-stations, and, third, the broadcasting of news of various kinds at different times of the day, either to all or only to given groups of subscribers.

The Wireless Selective Call developed by

the Dr. Erich F. Huth Radio Company, of Berlin, and demonstrated by Engineer Pohle before the recent Congress of German Physicists complies with all these requirements. It comprises a call transmitter and a call receiver, different times of call being used to differentiate between the various

being perceived only at the given individual station or group of stations.

The Call Transmitter is represented in Fig. 1 and comprises two concentric dials. The outside annular dial comprises an arrow and is so adjusted as to have that arrow point toward one of the small station

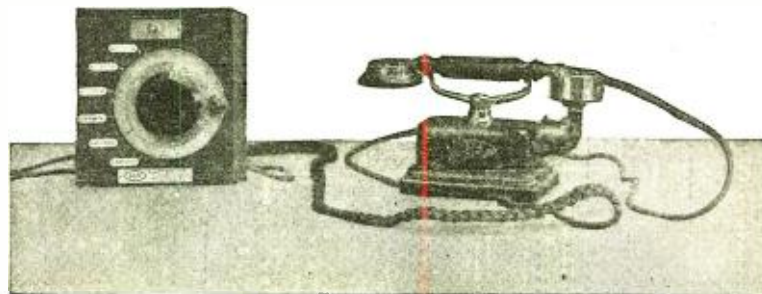

A View of the Call Transmitter. Any Desired Station Can Be Selected by the Knob and Dial.

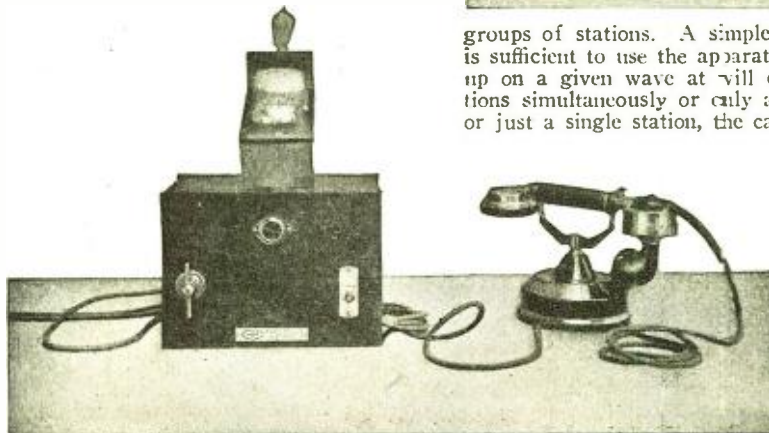

The Call Receiver. A Calling Station Actuates a Relay Which Closes the Circuit to a Bell.

groups of stations. A simple manipulation is sufficient to use the apparatus for calling up on a given wave at will either all stations simultaneously or only a given group or just a single station, the call signal then

marks, e.g., Munich, arranged round its circumference, after which the other dial is turned round as far as a stop and eventually released, thus winding up a clockwork in the interior of the Transmitter, the time of running of which depends on the adjustment of the former dial. As long as the clockwork is running, there will be an emission of electric waves.

In selecting a station it is of no importance whether the call transmitter is first actuated, lifting the receiver afterwards, or vice versa. When machines requiring lengthy starting or remote operation are used at the sending end, the call transmitter should be fitted with a special switch allowing the sender to be operated before selection. The call transmitter seen in Fig. 1

(Continued on page 1743)

# Electrons, Electric Waves and Wireless Telephony

By DR. J. A. FLEMING, F. R. S.

## Part II

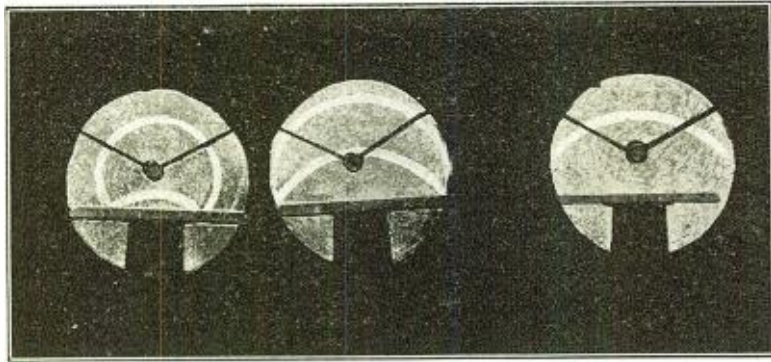

Fig. 20.—Photographs of Sound Waves Produced by an Electric Spark Between Balls. The Central Black Dots Are the Balls and the Inclined Lines, the Wires Leading to the Two Balls. The Sound Waves Are Shown Reflected From a Table.

**W**E have in the next place to explain the nature of a wave which is created in a material, and not simply on the surface of a medium. To follow this explanation necessitates some effort of the power of mental vision because objective perception is more difficult or impossible.

As already mentioned, there are two types of wave which can thus be produced, viz., compressional and distortional waves, depending upon the two kinds of elastic resistance which can be offered.

A *solid* is defined as a material which offers resistance to change of shape as well as to change of bulk or size. An elastic solid is one which when slightly changed in shape or size returns exactly to its original shape or size when the deforming force is removed.

A *liquid* or *gas* is matter in a physical state in which it offers elastic resistance to change of bulk or volume, but little or no resistance to change of shape.

The elastic resistance to change of volume is called volume elasticity; and the substance is said to have compressional elasticity or compressibility. The resistance to change of shape is called rigidity, and a substance which possesses elastic resistance to change of shape is said to have distortional elasticity.

In scientific language any change of size or shape in a substance is called a *strain*, and the corresponding force causing it is called a *stress*. Elasticity is numerically measured by the ratio of stress to strain in appropriate units. Hence in scientific language a substance is called highly elastic if it requires a relatively large stress or force to make a given small strain. In common language we generally say that a substance, for example, indiarubber, is very elastic if it stretches a great deal under a small pull; but in scientific usage we call a substance such as steel highly elastic because it requires a very large stress or force to create a relatively small strain, or stretches very little under a pull. The strain is always measured by the ratio of the change in volume or length to the original volume or length.

The two types of elasticity with which we are concerned in wave propagation, are the volume elasticity and the simple rigidity or shape elasticity.

Before discussing the way in which these qualities affect the speed of wave propagation it may be well to consider in detail the process of producing a space wave or wave in an elastic medium such as air.

Suppose a very sudden expansion of the air is made at one place by a little explosion or by an electric spark, the effect is to compress suddenly the air in a small spherical shell lying around that point. Owing to the inertia and compressibility

of the air this compression does not make itself felt at once at any great distance. When the explosion is over, this shell of compressed air immediately around the place of explosion expands again, and in so doing compresses the air in a spherical shell just outside the first layer. This again, in turn, releases itself and so the compression is handed on from layer to layer. If we picture to ourselves the region round the original center of explosion as divided into concentric shells like the coats of an onion, we can say that each shell in turn becomes compressed and then expanded again, passing from within outwards. This gradual transference of the compression from layer to layer constitutes a wave of compression, and in air at the temperature of melting point of ice (0° Centigrade) it travels at the rate of 1,090 ft. per second or nearly 700 miles per hour.

It can be proved by mathematical reasoning, though the proof is not given here since it is somewhat difficult to follow, that the speed at which a wave travels in an elastic medium is numerically equal to the square root of the quotient of the elasticity by the density using the appropriate units.

In a gas such as air the decrease in volume produced by an increase in pressure is such that if the pressure is applied slowly the product of volume and the pressure remain constant.

Let  $V$  be the original volume and let  $v$  be a small reduction in volume produced by an increase in pressure from  $P$  to  $P + p$ . Then by the above rule (Boyle's Law) we have—

$$(V - v)(P + p) = VP \text{ or}$$

$$P = \frac{v}{V - v} p = \frac{p}{v/V}$$

provided  $v$  is small compared with  $V$ . But  $\frac{p}{v/V}$  is the ratio of increase in pressure to

decrease in volume expressed as a fraction of original volume. This is therefore the compressional elasticity. Accordingly this last is numerically equal to the pressure of the gas at standard temperature 0° Centigrade. But the law of Boyle holds good for changes of pressure so slowly applied that no change of temperature takes place.

In the case of the compression produced in air waves, the pressure is suddenly applied and it can be shown that the elasticity with which we are then concerned is measured, not by the pressure  $P$  but by 1.41 times  $P$ .

To render the above explanations clearer we may consider a numerical example.

The pressure of the air at normal barometric height, viz., 760 mm. = 30 inches and 0° Centigrade is about 2116.4 pounds per square foot. But the so-called weight of 1 lb. is 32.2 absolute units of force in British foot, pound, second units; because a mass of 1 lb. acquires under gravity a velocity of 32.2 feet per second, whereas the unit force imparts a velocity of only 1 foot per second. Hence the pressure per square foot in absolute units of force is  $2116.4 \times 32.2 = 68,148$ . If we multiply this number by 1.41 we obtain the product 96088.68, which is the numerical value of the elasticity of air at 0° Centigrade and 760 mm. for suddenly applied pressure. The density of air at the same pressure and temperature is such that one cubic foot of air weighs 0.0807 pounds. Hence if we divide the number 96088.68 by 0.0807 and take the square root of the quotient, we arrive at a number close to 1,090, which is therefore the velocity of a compressional wave in air at the above standard pressure and temperature in feet per second. In the case of water the ratio of elasticity to density is nearly 17 or 18 times that for air and the velocity of a compressional wave in water is therefore rather more than four times its velocity in air.

Although we cannot see these compressional waves in air they can nevertheless be photographed by an ingenious process which may be explained as follows:—

If we look at a shallow pool of water on a bright sunny day when there is a slight wind producing ripples on the surface of the pool, we shall see a series of bright lines on the bottom of the pool, which move with the wavelets. The curved surface of the wave makes the water act like a lens and concentrates the sun's light on certain lines, corresponding to these waves.

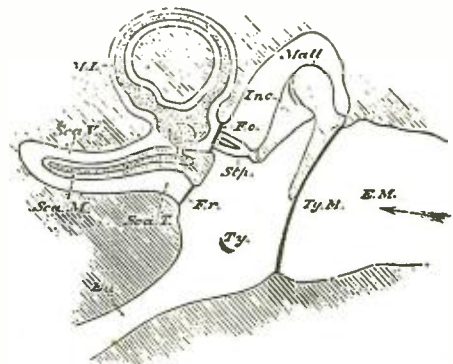
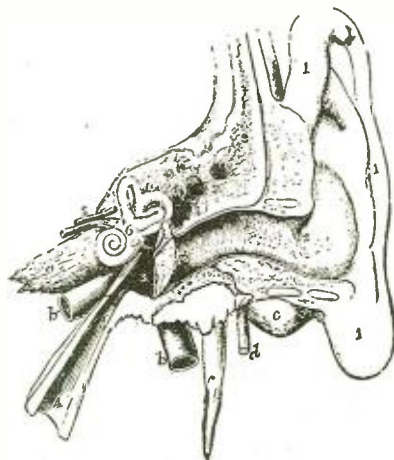

Fig. 21.—A Sectional Diagram of the Human Ear. 1. The External Lobe. 2. The Entrance Channel. 3. The Tympanum and Middle Ear. 4. The Eustachian Tube. The Chain of Bones or Ossicles Connecting the Tympana of the Outer and Inner Ear Cavities Are Shown in Diagram B.



A wave in air is a region of condensation followed generally by one of rarefaction and the compressed air acts to some extent like a lens on rays of light. Suppose, then, that we create a very sudden sound by means of the snap of an electric spark. This starts a sound wave which consists of a single region of compression followed by a region of expansion. This air wave can be allowed to flit across a sensitive photographic plate in a

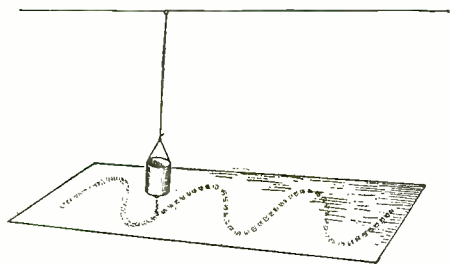

Fig. 22.—A Pendulum Having a Bob Delivering a Stream of Sand Which Marks a Simple Harmonic Curve on a Transversely Moving Strip of Paper.

dark room. It moves at the rate of 13,200 inches or so per second and therefore occupies about 1/2,000th part of a second in moving a distance of 6 inches.

Suppose a second electric spark is made at a distance from the plate, but so that its light falls on the plate. If the interval of time between the sound-creating spark and the light-creating spark is properly adjusted, the latter will impress on the photographic plate an image of the sound wave as it flits across the plate.

Some very successful experiments in photographing sound waves in this manner were carried out as far back as 1899 by Prof. R. W. Wood, and described by him in the *Philosophical Magazine* for August, 1899. He followed a method first used by Toepler, but with many improvements.

The light-giving spark was formed by the discharge of a small Leyden jar between two pieces of magnesium ribbon, clamped between two glass plates. An optical image of this spark was formed by a large lens, and the image nearly covered by a horizontal metal plate. Behind this was placed another lens which formed a faint image of the first lens on a photographic plate, which was thus uniformly illuminated. If, then, a sound wave produced by another electric spark, which takes place about one ten-thousandth part of a second before the light-giving spark is allowed to flit across the first lens, an image of the compressional wave in the form of a bright line appears upon the photographic plate when developed. We then see the compressional wave made by this spark as a circular ring-shaped image on the plate. If we allow the sound wave to impinge upon a reflecting surface we can see the reflected wave (see Fig. 20). We can in this way objectively inspect what takes place when compressional air waves are reflected or refracted in various ways.

Professor Wood was thus able to photograph air waves in the act of being reflected by plane surfaces or refracted by being transmitted through boxes, prisms or lenses of thin collodion, filled with gases such as hydrogen or carbon dioxide, in which compressional waves travel more quickly or more slowly than in air.

Although we cannot see these air waves with our eyes, we are provided with a pair of organs, our ears, which are extraordinarily sensitive to compressional waves in air, either solitary or in trains, provided their wavelength lies within certain limits, viz., about 30 ft. and 2 or 3 ins.

These waves excite in our ears the sensation of sound. In the human being

the external organ we commonly call the ear, is merely a wave collecting shell or sound catcher, and in animals such as horses, dogs, cats, etc., it assumes the form of a curved flap or ear trumpet capable of being turned in various directions.

The true ear or actual organ of hearing is set deeply in the skull, and in mankind may be likened to a sort of house with two rooms and an entrance hall. The entrance hall is the tube opening into the external air. This is closed at the bottom by a delicate membrane like the wing of a fly, which is called the drum or tympanum. The first room of the ear, called the middle ear, is a cavity which is bounded on one side by the first tympanum and has on the other side two other inner tympana or drums. This cavity communicates with the back of the mouth by a canal called the Eustachian tube, which admits air to the middle ear (Fig. 21). The inner and outer tympana are connected by a little chain of bones called the ossicles. When a compressional wave from the outer air enters the external tube and strikes the ear-drum, it presses it in, and if the waves continue to arrive the tympanum will be set in sympathetic vibration.

These motions of the outer drum are communicated across the middle ear by the chain of bones, and act on the inner tympanum. Behind this middle chamber and deeply buried in the bony framework of the skull lies the real organ of hearing, in and by which the mere mechanical motions of the tympana are translated into sensations of sound. This inner ear contains an organ called Corti's organ in which are spread out a vast number of nerve fibres which are extensions of the auditory nerve. It is in this inner chamber, the secrets of which physiologists have

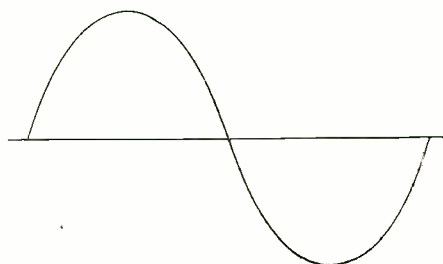

Fig. 23.—A Simple Harmonic or Sine Curve.

not yet been fully able to explore, that the transmutation takes place of physical motions into physiological perceptions, or sensations. The ear has a marvellous power of appreciating the frequency of the air waves which enter the outer ear, and also their amplitude, and in addition it detects that which is called their *wave form* or the degree of an admixture of waves of different frequency and amplitude. The difficult questions of physiology and psychology involved in the explanation of the functions of the ear in hearing do not concern us here, but it is important to understand clearly the differences between the motions in the air itself which give rise respectively to sensations corresponding to musical sounds, to mere noises, and to articulate speech.

In an air wave there is a place or places at which the air is slightly compressed, due to the air molecules being a little crowded together, and other adjacent places where it is rarified or the molecules less crowded together. These regions of compression and rarefaction are propagated or travel through the air, but the actual motion to and fro of the air molecules themselves at any one place which gives rise to these compressions or rarefactions is very small.

The late Lord Rayleigh (third Baron) made experiments in 1877 in the open air on a calm day with a whistle giving out a

sound or air wave having a frequency of 2,730. He found that such a whistle could be heard by a normal ear at a distance of 820 meters. The whistle was blown with a steady blast of air and from the power required to blow it he was able to estimate that the amplitude of motion of the air particles in the sound wave at the above distance from the whistle was only 0.8 of one millionth of a millimeter. This is less than one twenty-five millionths of an inch. Yet the human ear is able to appreciate the extremely slight changes in air pressure due to the motion.

Lord Rayleigh also experimented in 1894 on the amplitude of the least audible sound waves given out by a tuning fork vibrating 256 times a second, and found it to be about 1.27 millionths of a millimeter.

It will be evident from these figures that the expenditure of energy necessary just to excite a sensation of sound in the ear is extremely small. Measurements made of the energy necessary just able to excite a sensation of light when entering the eye, show that the human eye and ear are about equally sensitive to radiant energy.

In order that an air wave may be produced it is therefore necessary for some solid body or else some puff of air to strike the stationary air very suddenly.

When, for instance, we strike a gong with a drumstick, the disc of metal is pressed in at the center by the blow, and this produces a sudden local compression of the air on the opposite side which starts an air wave. The actual extent of motion of the wave-producing device may be invisibly small. Thus, for example, if we strike the prongs of a tuning fork and so set them in vibration, the motion is not visible to the eye. If, however, we hold near to the prongs a little pith ball suspended by a silk thread the rapid bouncing to and fro of the ball reveals the minute vibratory motion of the prongs. In the same way, although we cannot see the motions of the disc of the sound-box of a gramophone when it is playing, we can feel that it is in motion by holding the finger very gently just in contact with the disc. Even in the case of loud sound the amplitude of the motion in the gramophone diaphragm scarcely exceeds a few thousandths of an inch.

SOUND WAVES

The next question which must be answered is as to the nature of the motion of the air particles which takes place in sound waves. We have seen that it is an extremely minute motion to and fro in the direction in which the air wave is traveling.

If we suspend a weight from the end of a very long string, say three yards long, fixed at the upper end, and set the weight swinging, we have an arrangement called a simple pendulum. The motion of the bob backwards and forwards exactly resembles that of the end of a tuning fork emitting a pure musical sound, and it is called a simple harmonic motion. Let the bob of the pendulum be formed of a canister having a small hole in the bottom and let the canister be filled with fine sand. As the pendulum vibrates the sand will run out of the hole in a fine stream. Let it fall on a long sheet of card (see Fig. 22). If the card is not moved the sand will be merely distributed in a long,

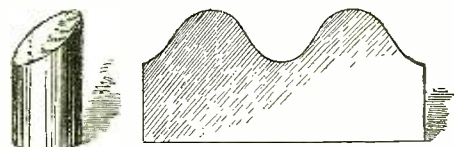

Fig. 24.—Method of Forming a Simple Harmonic Curve by a Sheet of Paper Cut to Fit Round a Cylinder With Oblique End.

straight ridge. If, however, we move the card steadily and uniformly in a direction at right angles to that of the line of vibration of the bob the sand will be distributed in the form of a smooth wavy curve, called a simple harmonic curve (see Fig. 23).

We can imitate this curve in the following way. Procure a cardboard tube having

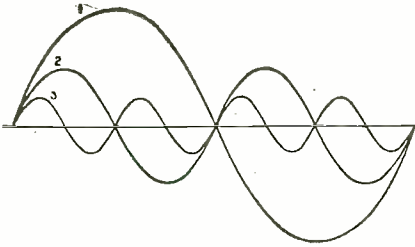

Fig. 25.—Simple Harmonic Curves With Wave-Lengths in Ratio of 1:½:¼.

a circular cross section and cut off the end obliquely with a sharp knife so that the slanting end will touch everywhere a flat surface applied to it. Then fold a sheet of paper several times round the tube, and with scissors cut the edge of the paper to match the sloping end of the tube. Then unfold the paper and its edge will be found cut into the form of a simple harmonic curve (see Fig. 24).

Obtain if possible four tubes respectively of diameters, 3 ins., 1½ ins., 1 in., ¾ in. and prepare in the above manner from them four sheets of paper with their edges each cut in wavy curves of the above kind, but the distances from crest to crest of the humps will be in the ratio of 1:½:⅓:¼. By placing these templates, as they are called, on a sheet of paper and passing a pencil round the curved edges, we can draw on the paper four simple harmonic curves which are said to have wave-lengths in the ratio of 1:½:⅓:¼ (see Fig. 25).

If we describe in this way, say, two superimposed simple harmonic curves with wave-lengths in the ratio of 1 to ½, we can then add together the heights of these two curves above the mean line and obtain a third periodic curve which is said to be the sum of the other two. This third curve will be more irregular but will repeat itself (see Fig. 26).

In this way we can add together or sum a number of simple harmonic curves whose wave-lengths are in the ratio 1:½:⅓, etc., and obtain very complex periodic curves which, however, repeat themselves in shape. Such curves are called complex periodic curves.

It is quite an easy thing to add together in this manner any number of simple harmonic curves of different wave-lengths and amplitudes, and in any relative difference of phase; that is to say, shifted relatively to one another, but with the mean or center lines of all the curves coincident, and thus obtain a complex curve.

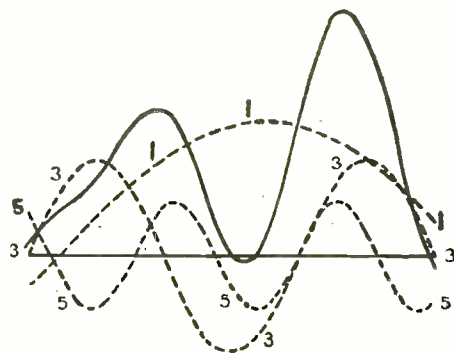

Fig. 26.—A Diagram Illustrating Fourier's Theorem. The Black Firm Line Is a Periodic Curve and the Dotted Lines Its Harmonic Constituents With Wave-Lengths in Ratios 1:1/3:1/5.

FOURIER'S THEOREM

Strange to say, it is possible to perform the reverse operation, and if we are given a complex periodic curve which repeats itself regularly, we can find out what are the simple harmonic curves out of which it is built up. The fact that this can be done for certain periodic curves was discovered by a great French mathematician, Fourier, and it is in consequence called Fourier's theorem.

The importance of this fact in connection with sound and music is very great, because it shows us that simple musical sounds, such as those of a tuning fork or open organ pipe, when combined together, can produce air waves in which the to and fro motion of the air particles is very complicated and can only be represented by the varying height of a complex curve corresponding to various distances along its mean line taken as an axis of time. Also Fourier's theorem shows us that such sounds can be analyzed into a number of pure musical sounds represented by simple harmonic curves.

Before proceeding further it will, however, be an advantage to explain the manner in which we can determine the nature of the motion of the air particles in air

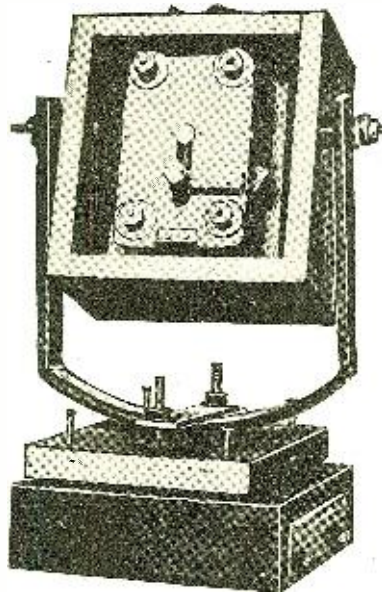

Fig. 27.—The Phoneidoscope.

waves given out by various sound producing sources. This is accomplished by means of an instrument called a Phoneidoscope, which is a word meaning "sound forms rendered visible."

It will perhaps be new to some readers to learn that every sound has a certain shape of wave form.

We recognize that there is a great difference between a mere noise and a musical sound, and also that there is a remarkable difference between the quality of the sound given by various musical instruments, even when playing the same note. Also we know that in articulate speech there are great differences between the various vowel sounds, even when pronounced in the same tone and loudness.

The phoneidoscope enables us to ascertain the external or physical differences which correspond to these various kinds of sounds considered as sensations. It is constructed in the following manner (see Fig. 27):—

A metal ring has been clamped to it a circular disc of very thin glass or transparent mica. This disc is best made about 2½ ins. in diameter, and the ring may be fixed at the narrow end of a wooden trumpet, like a gramophone horn. When an aerial wave enters this horn it presses the disc or diaphragm as it is called, slightly out-

wards, and if aerial condensational waves continue to arrive, the disc is set in sympathetic vibration. To the center of this disc is attached a small aluminum pin, cut with a chisel-shaped edge. This chisel presses on the underneath side of a small piece of celluloid, which is pivoted by a wire passed through its center, and on the

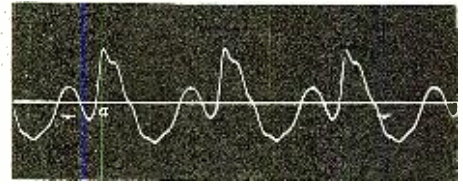

Fig. 28.—Wave Forms of a Musical Sound as Rendered Visible by the Phoneidoscope.

other side of the center is a steel spring, which presses the celluloid up in the same direction as the pressure of the aluminum chisel. The little bit of celluloid has a small circular silvered glass mirror cemented to it. It will then be seen that if the mica disc moves to and fro or vibrates it will cause the little mirror to rock on its axis and the movements of this mirror will copy exactly the movements of the center diaphragm. A ray of light is allowed to fall on this mirror and is reflected on to another steadily revolving mirror. The axis of revolution of this last mirror is so placed that if the diaphragm is at rest, the spot of light is carried horizontally across a screen, and in virtue of the persistence of vision, appears as a narrow line of light. If, however, vibrations of the mica diaphragm take place, the spot of light is caused to move up or down and the line of light becomes a more or less regular wavy line of light (see Fig. 28). With this apparatus we can try the following experiments.

If we make near the horn any pure musical sound, we see the line of light thrown into a wavy line of simple harmonic wave form. If the sound is loud, the amplitude or height of these waves is large; but if the sound is feeble, the height is small.

Again, if we sound various notes from organ pipes or pitch-pipes, we find that if the sound is a low or bass note, the wavelength of the light line waves is large, but if the sound note is high or shrill, then the wavelength is small.

If we sing to the mica diaphragm various vowel sounds, Ah, Ee, Ay, etc., we find that the shape or wave form of the light line is different in every case. If we speak to the diaphragm or recite, the line is thrown into an irregular shape (see Fig. 29).

We see, therefore, that since the amplitude or extent of motion of the mica disc is a measure of that of the air particles which beat against it, we may conclude:

- (I) that the amplitude of motion of the air particles determines the loudness of the sound.
- (II) that the frequency of their vibration or what comes to the same thing, the aerial wavelength de-

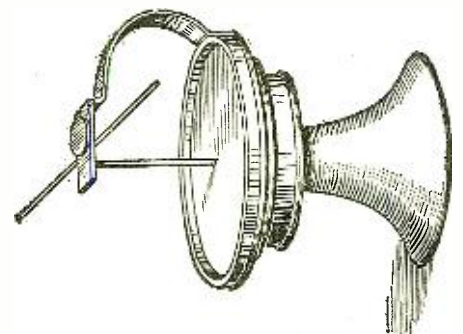

Showing the Mouthpiece Diaphragm and Tilting Mirror of the Phoneidoscope

termines the pitch of the sound, and

(III) that the wave form or sound shape of the aerial vibrations determines the quality of the sound.

A musical sound results from regularly repeated aerial vibrations, of a certain wave form. A mere noise results from irregular aerial vibrations, and articulate speech results from aerial vibrations of certain specialized forms.

Since the complex wave form of vowel sounds can be analyzed into the sum of a number of simple or pure musical tones, it is possible to arrange a certain number of organ pipes to certain selected notes, so that when sounded together, they give out the vowel sounds *Ah* or *Oh* (see Figs. 29 and 30).

THE GRAMOPHONE

It is clear there are many matters of great scientific interest in connection with that popular instrument the gramophone. There are two types of this instrument, one employing a needle and the other a jeweled point in the sound producing portion.

On examining a gramophone record we find it to be a disc made of a certain composition which softens with heat, and on it is a close spiral groove cut in the plate. In the needle records this groove is smooth at the bottom but irregularly indented at the side. The record is made to revolve steadily at about 90 revolutions a minute by the clockwork. The so-called sound-box consists of a flat metal box, carried on the end of a hollow arm, and this box has a circular disc, generally of mica as the outer face. The center of the disc is screwed to a pivoted arm, ending in a needle which rests in the groove in the record. As the record revolves, the needle travels in the groove, but is jerked to and fro by the irregularities on the side of the groove. This causes the lever to impart corresponding vibrations to the mica disc of the sound-box, and these create aerial waves which travel up the tube and make their exit from the horn. In the case of the Pathé gramophones the groove in the record is smooth at the sides but irregularly indented at the bottom. The sound-box lever ends in a metal point tipped with a small sapphire ball. This ball travels along the record groove and jumps or bounces over the uneven bottom like a bicycle on a rough road. These vibrations are communicated to the sound-box disc and then to the air.

The marvelous thing about the gramophone is the perfect manner in which it can reproduce complex sounds such as speech, singing, noises of animals, bell ringing, cornets and violins playing and even hammers beating on anvils. The outline or profile of the irregularities on the side or bottom of the groove in the record is a copy of the wave form of the sound originally impressed on the master record, and this is faithfully reproduced in the aerial vibrations created as above described by the copies of the master record, which are sold to buyers.

This is perhaps the place to make reference to the history of a type of gramophone which is capable of giving a vastly louder sound or wave amplitude than the

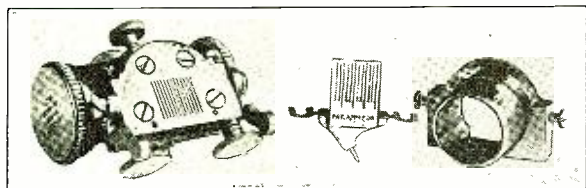

Fig. 31.—The Slotted Plate and Comb Valve of a Creed Stentorphone Similar to That Previously Invented by Sir Charles Parsons.

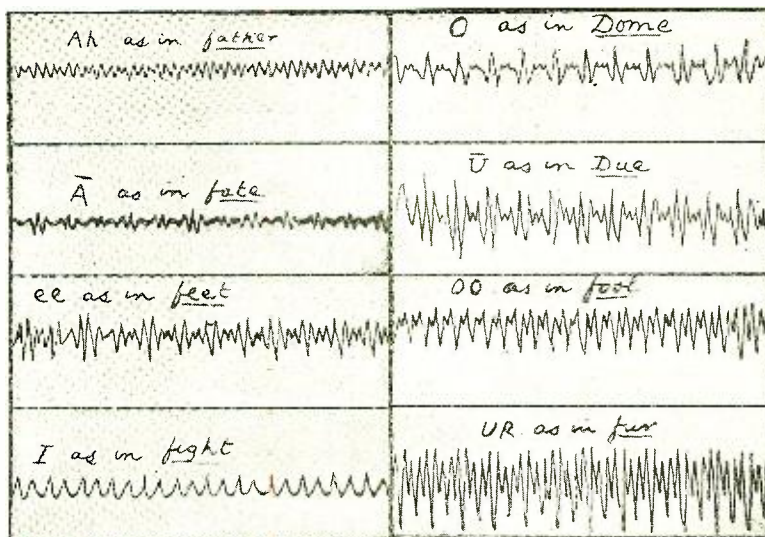

Fig. 29.—The Wave Forms or Shapes of Various Vowel Sounds as Photographed by the Fleming Phonoscope.

ordinary instruments. In this case the power required to create the aerial waves is not derived merely from the clockwork driving the record, but from a supply of

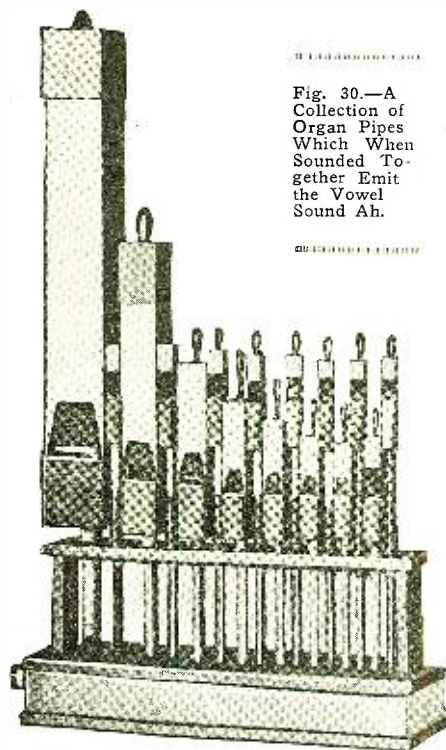

Fig. 30.—A Collection of Organ Pipes Which When Sounded Together Emit the Vowel Sound Ah.

compressed air furnished by an electric motor and pump. All that the rotating record does is to control the emission of this air and modulate it so as to produce aerial waves.

A sudden puff of air is capable of starting a compressional wave into existence in surrounding air. In fact, this is the underlying principle of all so-called wind musical instruments, e.g., organ pipes, reeds, trumpets, cornets, flutes, etc.

Suppose, then, that a jet of compressed air is issuing from a pipe. If we can apply to the end of the pipe a valve which will control the jet of air and modulate it in accordance with the wave form of a musical sound, we shall produce the corresponding aerial waves.

Edison seems to have had the idea in 1876 that if such a valve could be controlled by the voice, then an instrument could be made which would greatly magnify it or act as an amplifier of speech.

In the late years of the nineteenth century Mr. Hor-

ace L. Short devised a valve intended to be used for this purpose, and a few years later the eminent engineer, Sir Charles Parsons, the inventor of the steam turbine which bears his name and has effected such a revolution in ship propulsion, turned his attention to the subject.

He invented a peculiar kind of valve consisting of a metal plate with very close narrow slits in it. These slits were closed by a kind of steel comb, the teeth of which overlaid the slits and closed them. If the comb was raised a little the slits became more or less open. Compressed air was supplied under the slotted plate, and its emission controlled by very slight movements of the metal comb, which last were actuated by the vibrations of some musical instrument or by a gramophone record. In this manner very powerful aerial vibrations were created by means of feebler sounds. This invention of Sir Charles Parsons was named an "Auxetophone," and it was exhibited to the Royal Society in London in 1904, and also at the Royal Institution. It was employed in 1906 to amplify the sounds of musical instruments, violins, double bass, cellos, etc., but its introduction was blocked or boycotted by the band-playing fraternity because they thought it would reduce the number of executants required in bands.

More recently, a similar type of instrument has been evolved by Mr. Gaydon and manufactured by Mr. Creed, of Croydon, the well-known inventor of telegraphic printing instruments. This last form of instrument has been called a stentorphone.

Messrs. Creed and Gaydon have now perfected a form of comb-valve which can be attached to the arm of a gramophone and actuated by any needle record. The valve is supplied with compressed air under a pressure of 10 lbs. on the square inch, furnished by a simple form of rotary pump driven by an electric motor of 1/2 horse power. The indentations on the record, acting through the needle, control the motions of the comb-valve (see Fig. 31), and this, again, controls the emission of the air (see Fig. 32). The instrument therefore gives a much greater volume of sound than the ordinary gramophone, and can be heard over very large halls or for great distances in the open air. The general appearance of the instrument with its air compressor is shown in Fig. 33. The electric motor can be driven off any electric light supply circuit.

THE VELOCITY OF SOUND WAVES

This discussion of aerial waves would probably be incomplete without some reference to methods of measuring their velocity, since these measurements have of late years received important practical applications in methods of sound-ranging for

(Continued on page 1666)

# Experiments With the Two Plate Condenser Antenna

By JOHN C. WARNER\*

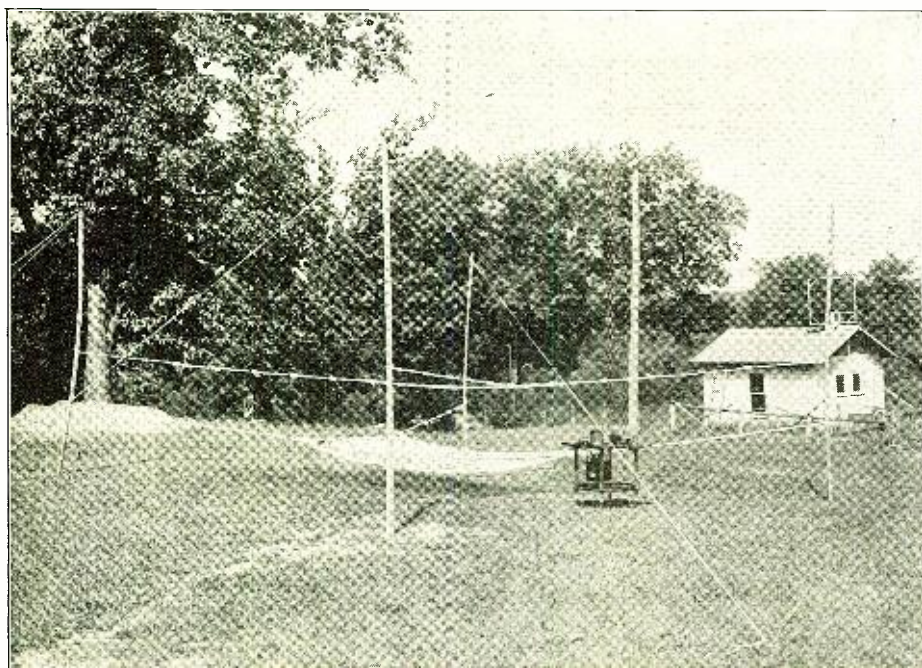

This Clearly Shows the Method Employed for Supporting the Plates of the Condenser Antenna. The Receiving Set Is Shown on the Small Table. Note the Loop Aerial on Top of the house.

THE development of modern electron tube receiving equipment has made possible the use of relatively small antenna structures. The coil antenna or loop is a common example of the small antenna which has come into use on account of its reduced dimensions and directional properties. Another antenna of entirely different form has been investigated recently. This has been known as the condenser antenna, as it consists merely of two plates which form the two sides of a condenser. However, this name is also descriptive of the ordinary open, elevated antenna and for this reason the name "two plate condenser antenna" or simply "two plate antenna," which has been suggested recently, seems to be more applicable to this special form of antenna.

The effect of reducing antenna dimensions may be seen from the well-known transmission formula

$$I_r = \frac{188 h_s h_r I_s}{R \lambda d}$$

where

- $I_r$  = current in receiving antenna in amperes.
- $h_r$  = height of receiving antenna.
- $h_s$  = height of transmitting antenna.
- $I_s$  = current in transmitting antenna.
- $\lambda$  = wavelength.
- $R$  = resistance of receiving antenna in ohms.
- $d$  = distance between stations.

Thus, if the height is reduced, the only means of preventing reduction in received current, conditions at the transmitting station remaining constant, is to decrease  $R$ , the resistance of the receiving antenna.

Antenna resistance, in general, is made up of three components, radiation resistance, resistance of conductors, including eddy current losses in the antenna itself and in nearby conductors, and resistance due to dielectric losses in the field of the antenna.

A two-plate antenna can be designed so as to reduce greatly the conductor resistance and also the losses in the field so that the total resistance is only a small fraction of that resistance of the ordinary elevated antenna.

The experiments to be described were carried out at the Radio Laboratory, U. S. Bureau of Standards, Washington, D. C.

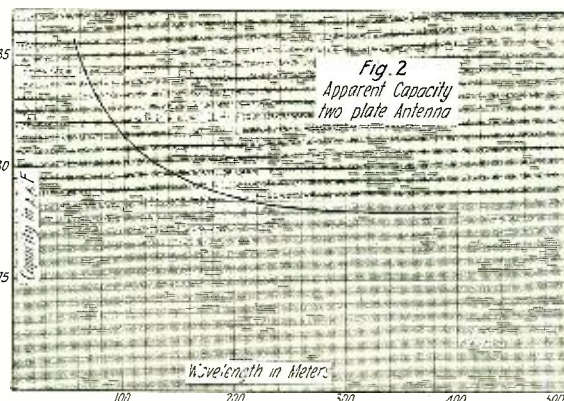

Curve for Determining the Capacity Required for Various Wave-Lengths.

for the purpose of determining the various electrical properties of the two plate condenser antenna.

The antennae used in these tests were all made of ordinary screen wire netting, some

iron and some copper. These were mounted in a suitable supporting frame so that the distance between plates and the height above the ground could be varied. Fig. 1 shows the method of supporting the antennae in these tests. Plates of various dimensions were used, ranging from 400 cm. x 180 cm. down to 180 cm. x 45 cm. Experiments on directional effect were made with the aid of a frame which could be rotated.

### MEASUREMENT OF CAPACITY INDUCTANCE AND RESISTANCE.

Capacity measurements were made at wavelengths varying from 50 to 400 meters, by comparing the antenna capacity with that of a known standard. The apparent capacity measured in this way decreases slowly as the wavelength is varied from 50 to about 400 meters on account of the inductance of the antenna of which no account is taken in this substitution method. However, this forms a convenient method for determining the true capacity and inductance since if the apparent capacity is known at two different wave-lengths the true capacity and inductance can be calculated from the formula.

$$C_a = \frac{C_o}{1 - 3.553 \frac{L_o C_o}{\lambda^2}}$$

- where  $C_a$  = the apparent capacity.
- $C_o$  = true capacity.
- $L_o$  = inductance.
- $\lambda$  = wavelength.

The apparent capacity is measured at two different wave-lengths and the corresponding values substituted in the formula; thus two equations are given which can be solved for  $L_o$  and  $C_o$ . Fig. 2 shows a typical capacity curve. The true capacity of this antenna, which had an upper plate 400 cm. x 90 cm. and lower plate 400 cm. x 450 cm. spaced 80 cm. apart, was 78 micro-microfarads, while its inductance was only .9 microhenry, and the resulting natural wave-length about 16 meters. From this, it can be seen that the inductance is so small as to be almost negligible and that this form of antenna is very nearly a true condenser antenna.

A lengthy series of resistance measurements was made which gave very interesting results. Particular notice was taken of means of reducing resistance, because it is only in this way that compensation can be made for the reduction in dimensions.

Measurements of resistance were made by

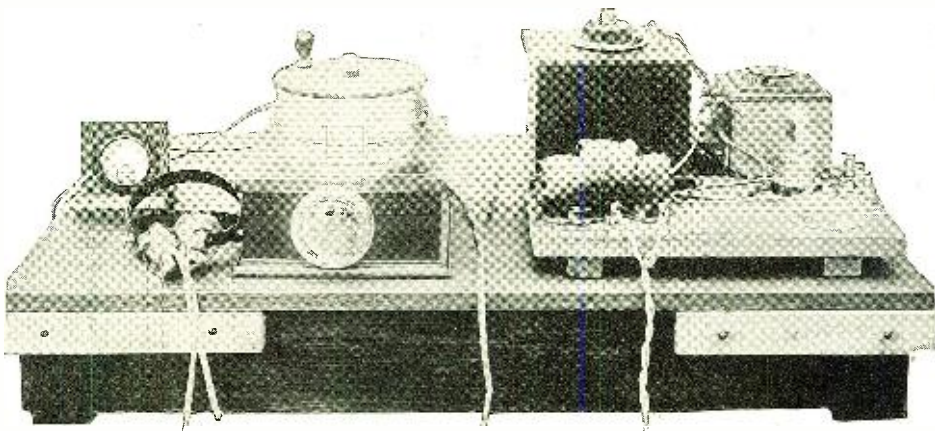

Fig. 5. The Assembled Receiving Set and Measuring Instruments Used in the Signal Comparison Tests.

\*Formerly Asst. Physicist, U. S. Bureau of Standards.

the usual resistance variation method. First, the resistance of the complete antenna circuit, including tuning inductance and a thermo galvanometer, was measured, then a standard variable condenser was substituted for the antenna and another measurement made. The difference between these two readings gave the difference between the resistance of the antenna and that of the standard condenser. This was practically the same as the resistance of the antenna since the standard condenser had negligible resistance.

Measurements were made at several different wave-lengths in order to determine the variation of resistance with wavelength. Fig. 3, Curve A, shows a typical case. The general shape of this curve is similar to what is often obtained from an ordinary antenna, but the actual values are considerably lower.

Examination of this resistance curve and others which were obtained shows that the dielectric loss component of resistance is high compared to the other components. The next step taken was an attempt to reduce this source of energy loss. An antenna composed of a small plate mounted over a much larger one was measured and found to have considerably less resistance. This difference in resistance was without question due to the fact that the large lower plate shielded the upper in such a way as to reduce the ground currents and the resulting resistance losses.

The effect of poor dielectrics between the antenna plates was also investigated. Various objects were placed between the screens and the increase in resistance measured. In one case, a wet board about ten inches wide and as long as the antenna was placed between the plates. This increased the resistance from 2.4 to 6.0 ohms.

In an attempt to secure minimum resistance, one antenna was built using plates made of copper screen. Fig. 3, Curve B, shows the resistance curve for this antenna, which had the same dimensions as the antenna on which Curve A was made. Both of these antennae had plates of the same size. Curve C on Fig. 3 shows the effect of folding double the upper plate; thus the amount of metal remained the same, but the upper plate was shielded from the ground. Decreasing the distance between plates still further reduced the resistance and at 20 cm. between plates the resistance was only .14 ohm at 175 meters. This spacing is, of course, too small for practical purposes.

It is interesting to compare the resistance curves of the two-plate antennae with those of two coil antennae which were used later

Fig. 6. Another View of the Receiving Set Used During the Experiments. One of the Condenser Aerial Plates Is in the Background.

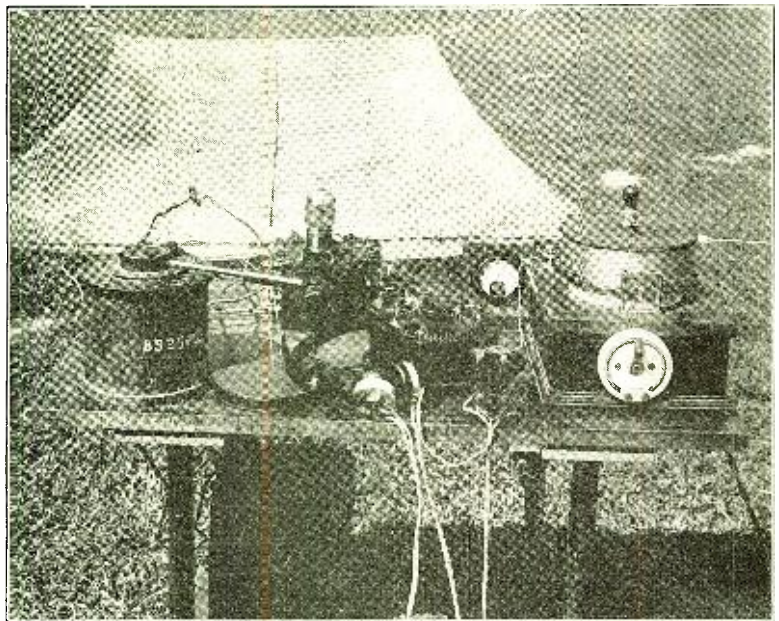

in signal intensity measurements. These curves are marked D and E on Fig. 3. Not only is the shape of these curves different, but the minimum value is much higher than the minimum found for the

audibility meter. It was found that this was utterly unsuited to this work. Not only was it impossible for two observers to check each other's work, but one observer could not repeat his own observations with any degree of accuracy. Consequently it was necessary to employ a different method for the signal intensity measurements.

It is possible to measure the strength of a signal by comparing it with another of the same pitch and quality, whose intensity is known, and this method was finally adopted.

The comparison signal was furnished by a small audio frequency vacuum tube oscillator. Fig. 4b shows the diagram of connection and Fig. 5 the assembled set. Fig. 6 shows the complete receiving set and the galvanometer and potentiometer used in the signal comparison set. The output current of this passed through a known resistance R and a milliammeter (S), thus giving known voltage drop across the resistance. By means of the slider any fraction of this voltage could be applied to the phones. To make a measurement the phones were connected to the receiving set by means of the D. P. T. switch and the receiving set tuned to give the maximum signal. The switch was then thrown back and forth from the receiving set to the comparison set and the slider adjusted until the signals were of equal intensity, that is, the signal voltage was equal to the voltage drop across RS. This method, while requiring some slight experience before it could be used quickly, was capable of giving very good accuracy.

The coil antennae previously mentioned

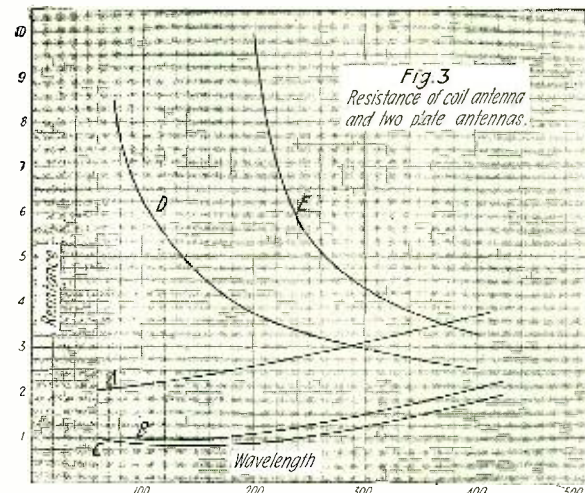

Curves Representing the Resistance of Different Condenser Antennae at Various Wave-Lengths.

two-plate antennae. Curve D was taken on a coil consisting of two turns on a frame 90 cm. x 123 cm., while Curve E was taken on a coil of seven, turns on a frame 80 cm. square.

**SIGNAL INTENSITY MEASUREMENTS.**

Since the final test of any antenna is its ability to send or receive signals, particular stress was laid on the measurement of received signal strength in which comparisons were made with the two coil antennae mentioned previously.

Signals were transmitted from a small transmitting station located about one-eighth of a mile from the antenna. The transmitting set was designed to give a continuous wave of 200 to 450 meters modulated at 1000 cycles. The receiving set was a simple non-regenerative detector connected directly across a fixed inductance in series with the antenna. Fig. 4a shows this circuit. A different inductance coil was used for each wavelength at which measurements were made and fine adjustment was accomplished by means of a small variable condenser shunted across the inductance.

Careful record was kept of the current in the transmitting antenna, so that the conditions did not change during the test.

At first, an attempt was made to measure the signal intensity by means of a so-called

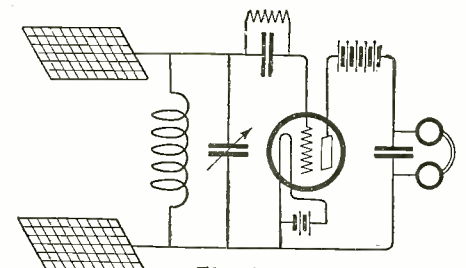

Fig. 4-a

Circuit of the Receiver Set Proper. A Different Inductance Was Used for Each Wave-Length at Which Measurements Were Made.

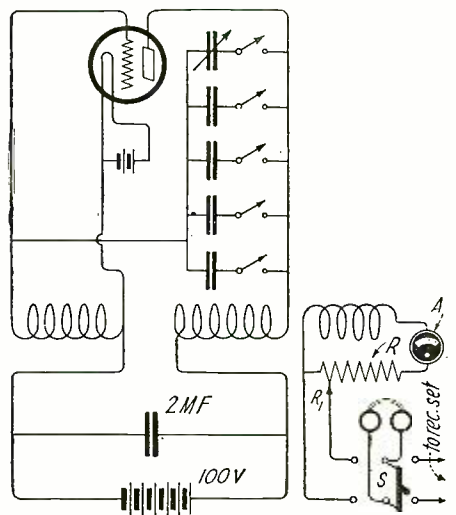
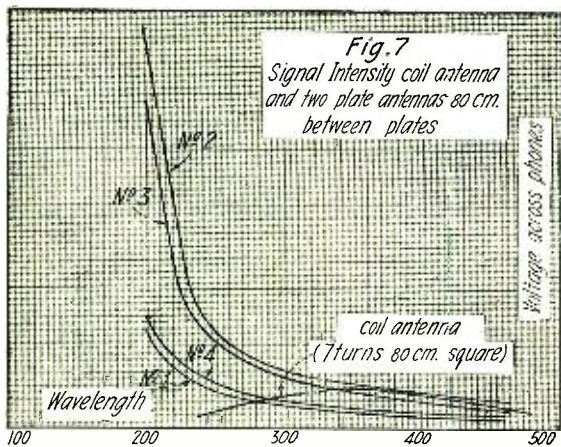

Fig. 4-b

Diagram of Connections of the Test Circuit Used for Measuring Purposes.



A Curve Showing the Results of Measurements Made on Four Two-Plate Antennae and the Seven Turn-Coil Antenna.

were used as a basis of comparison and measurements were made on these and on several different two-plate antennae at different wave-lengths. Fig. 7 shows the results of measurements made on four two-plate antennae and the seven turn coil antenna. Dimensions of the two-plate antennae were as follows:

	Upper Plate	Lower Plate
No. 1	180 cm. x 45 cm.	180 cm. x 45 cm.
No. 2	310 cm. x 90 cm.	400 cm. x 180 cm.
No. 3	360 cm. x 45 cm.	400 cm. x 180 cm.
No. 4	180 cm. x 45 cm.	400 cm. x 180 cm.

A second series of measurements was made with 120 cm. distance. Results were similar to those shown in Fig. 7, except that all magnitudes were greater. In making these two series of measurements, the distances between plates were made equal to the heights of the two coil antennae, although the lengths of the two plates were considerably greater than the corresponding dimensions of the coils.

From these results it is clear that the

two-plate antenna of the dimensions shown has considerable advantage over a small coil antenna at wave-lengths under 250 meters, but that above about 300 meters the coil gives greater signal strength. A few measurements were made on wavelengths of 1100 and 2500 meters, but the signal intensity was much less than given by a coil antenna of eleven turns, one meter square.

Fig. 8 shows the effect of signal intensity of changing the distance between the two plates. The signal intensity increased about as the square of the distance between plates except when the plates were very close together. That is, the voltage induced in the antenna was approximately proportional to the distance between the plates.

Brief experiments were made to determine the directional characteristics of the antenna and it was found to be only slightly directional. This was, of course, to be expected since the ratio of length to height was small.

The Bureau of Standards tests show that the low resistance of the two-plate antenna gives it a decided advantage over other forms of antennae. However, the impression should not be given that this feature alone makes a two-plate antenna as effective as a large overhead antenna when loud signals are desired. Amplification is almost as necessary with the two-plate antenna as with the coil antenna. The two-plate antenna does,

however, lend itself to indoor use even though the dielectrics so introduced into its field raise the resistance somewhat. The lower plate may be conveniently located under a rug, and the upper plate hung near the ceiling; or a somewhat modified upper plate may be made by running a wire around the room near the ceiling, perhaps concealing the wire behind picture molding or the like. The two ends of this wire should be connected together in this case.

It is quite evident that the experiments described are only of a preliminary nature, and that a large amount of work remains to be done before the full capabilities of this interesting form of antenna are fully known.

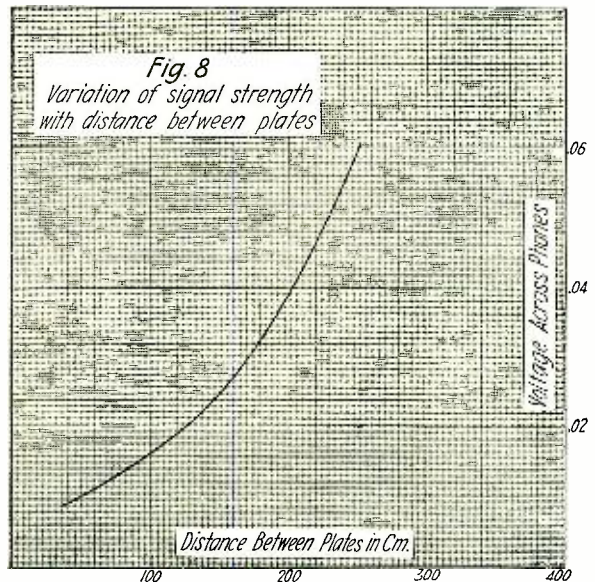

The Effect on Signal Intensity Upon Changing the Distance Between the Two Plates.

# Reducing Interference

By J. R. TANNEHILL

SIX months ago the conversation of every radio broadcast fan was limited almost entirely to the subject of "static." If any listener in the south could have hooked up his home-made regenerative receiver and tuned in a station 1,000 miles away and heard snatches of the program, he would have been satisfied, even if the amateur on the next block had knocked his phones off two or three times

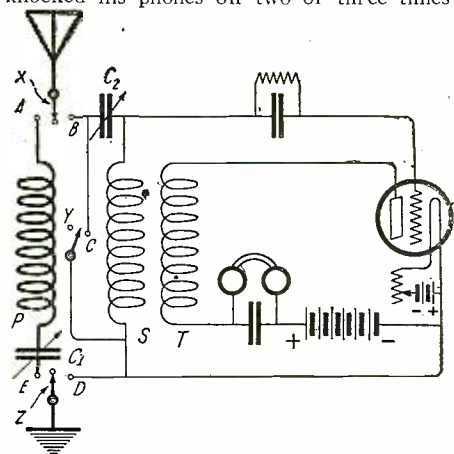

A Circuit Designed Especially for the Elimination of Undesirable Signals. By Means of Switches It Can Be Changed to a Single Circuit Tuner At Will.

with a half-kilowatt spark and the signal had been badly heterodyned by some local station broadcasting canned music.

Today the same listeners tune in ten to twenty stations and if two of them happen to be on the same wave and produce a slight whistle they write to Congress about the air congestion. If some amateur breaks in while the broadcast fan is listening to a weak station 1,500 miles distant, the latter writes his grumblings to the radio inspector.

All of this sounds like poor sportsmanship, and yet we all do it.

With radio it is difficult to be reasonable. My situation is just this: Being at a seaport of considerable importance, the ships come in like a bunch of humble bees. The local radio station is about one mile distant. When plugged in on two stages, the listener gets that Naval station's signals like a blow on the ear with a hammer. Two hundred feet away from me is station 5VY, operated by an energetic young man who claims he uses only 5-watt tubes. I suspect that he is secretly operating about half the world's supply of 250-watters. At any rate, when he comes in on 200 meters, he paralyzes me up to about 800 meters; and there are many others.

However, we must be reasonable; there is nothing to it but to try various means of eliminating the interference. In the last three months I have tried out everything

available to get rid of this QRM. Since the general howl over the country seems to be on the subject of interference, perhaps these experiences will be interesting to others.

First, a confession, I am addicted to the use of the single-circuit regenerative tuner. With an outside antenna, such a circuit misses nothing in the neighborhood. Yet, it affords simplicity of tuning and stronger signals than other circuits. When the atmospheric conditions are favorable and interference is at a minimum, there is nothing so satisfying as a good single-circuit. I do not desire to discontinue its use, and probably others are of the same mind. Yet, there are times when brother amateur on the corner begins a series of messages that you know will require an hour, and your single circuit sounds like a boiler factory. What is needed is a flexible circuit, allowing the operator to change to a more selective type on a moment's notice. And that selective type must be one that will eliminate the interference, and no one wants to spend a small fortune in constructing such a circuit. Will it be a loop or an inductively coupled circuit on the outside antenna? Or will it be necessary to use a wave trap?

The best method is to work on the source of greatest interference. If you eliminate that, the chances are that the remainder

(Continued on page 1729)

# Results of the \$500.00 Prize Contest

## Who Will Save the Radio Amateur

By E. T. JONES  
Fourth Prize

**S**ELDOM if ever have we read an article similar to Mr. Perry's in the October issue of RADIO NEWS. *He is the Paul Revere of Radio.*

Mr. Perry's article was no doubt prompted by the *half-witted, prejudiced* letters which have been flowing in to the Editor for publication in the "Correspondence from Readers" columns.

The Editor was broadminded enough to print them for the whole world to read and then gave his own version of the situation.

It is just that type of Amateur who is Doomed—beyond saving, and no matter what efforts are made to cope with the TYPHOON which is surely heading toward every amateur's door—he will not stand a chance of being saved.

The writer is an Amateur and proud of it. Has been operating an Amateur station since the year 1908 and has never had his station out of commission once during that period.

**THE ONLY REAL SERVICE WHICH HAS BEEN DONE BY THE AMATEUR SO FAR IS THE VALUABLE ASSISTANCE GIVEN UNCLE SAM DURING THE GREAT WAR.**

This is something to remember and which will be remembered forever and forever. But we do not have wars every year. We may not have another for twenty years.

Nothing could take away from the amateur what he has done for the country and for radio; however, what has he been doing with his transmitting set since this emergency terminated? What did he do with his transmitter previous to the emergency?

Listen in any night and get a drift on the type of messages which are being handled and form your own opinion as to what could be accomplished if the same efforts were employed to some real cause.

### LACK OF REGULATION

There has always been a need for strict regulations governing an amateur with a transmitting set. We have allowed this to be put off until now we are bumping our heads against a concrete wall hunting a solution.

It is the kid with an amateur transmitting set "jamming the ether" with such as this "How is my spark this afternoon?" "What show did you go to last night?" who always causes trouble for the better class of Amateurs who are transmitting over considerable distances and who are now putting Amateur Radio up for trial and possible doom if some action is not taken at once.

The writer has always thought it unwise to issue licenses to kids with small transmitting sets who cannot receive over fifteen words per minute. We need to take strenuous action ourselves and keep this class of amateur satisfied with a receiving set until such time as he can receive at least 20 words a minute.

Of course I expect wails from all quarters from those in the class I am anxious to eliminate from the transmitting field; however, as Mr. Perry states, the "Amateur is doomed unless something is done at once."

It is grand and glorious to have a transmitting set but it is like putting a pistol in the hands of a five year old child to put a transmitting set in anyone's home who is not

capable of receiving at least 20 words per minute.

### SUPERFLUOUS CONVERSATIONS

Why is it that there are no regulations governing the Amateur who wants to write a novel over the ether? Commercial operators are dealt with severely when they are logged for conversing unnecessarily. **WHY NOT THE AMATEUR?** This will undoubtedly cut down the number of transmitters working. *It must be done!*

### REAL AMATEUR SERVICE

Why not solicit messages from those purely interested in receiving the concerts and forward or relay what they have to report to the big broadcasting stations? Everyone is using the wire and paying for the reports they send into the big stations reporting how they received their concerts. This can be regulated so that but one message will be accepted from any one person for one particular broadcasting station.

Ascertain just where the weather and crop as well as market reports are not being received regularly and arrange to relay them. Ask for space in the local papers and print everything worthwhile. Show the PEOPLE that you are a real service—an asset to the community.

Outside of what the Amateur did during the war—the average novice looks on them as a body of kids and grown up kids tinkering with a lot of stuff that "Sounds well but does not mean anything." That has been the trouble all along. We have been too self-centered. We cared not what others thought but now we are brought down to the carpet and realize that we **MUST CARE**. So let's get together and see what there is to be done to ward off this ever onrushing wave of broadcast popularity and make ourselves a permanent place in the radio field.

The writer has not only read the bunk which was written in to this magazine by some unscrupulous kids of the type who must be either set right or ostracized from the amateur radio fraternity, but has on several occasions heard real dyed-in-the-wool Amateurs sling the same two-edged sword which generally proves more harmful to the user than anyone else. This kind of foolishness must cease. We have to be serious and fairminded if we want the public to recognize us. We can't afford to act like two-year old babies.

### WHAT MUST BE DONE

Amateurs must organize stronger than ever. They must get together where there are two or more factions working against each other and re-organize into one large body or club.

After that has been accomplished—the riot act must be read to all those who have transmitters creating interference not only for radiophone reception but for the DX operators. Those who are not capable of receiving at least fifteen words per minute should be requested very forcefully to keep their transmitter, out of the air until such time as they can really operate fast enough to do the amateurs as well as the community some real good.

Amateurs must be taught to co-operate with their new entrants into the radio receiving field. By lending them all the assistance you can instead of criticizing them about their ignorance of matters pertaining to radio, we will gain their support. Very few if any will "Bite the hand that feeds them."

Boiled down to brass tacks we have an altogether too loose a working policy, be-

tween ourselves and the present condition in the amateur field resembles closely the conditions in Ireland or Mexico. I am frank to admit it. *We need some real legislation drawn up by the Amateurs for the Amateurs.*

I claim that a transmitting set in the hands of one not capable of transacting bonafide business is nothing short of criminal. The people who are buying radio receiving apparatus in order to pick up the radio broadcast concerts are certainly not going to stand for our butting in on their music and changing a perfect operatic rendition into a cross between a kitchen sink and a cock fight.

*Again, there is absolutely no excuse for our doing so.* Therefore I say to you real Amateurs who have the longevity of Amateur Radio at heart "*Spare not your brother if he is guilty of such.*"

There are then only two things to be done in order to preserve the Amateur rights:

- 1 *Organize stronger than ever.*
  - a Eliminate the wind jammer.
  - b Co-operate with the novice.
  - c Raise the operating standard.
  - d Do away with spark transmitters.
- 2 *Perform a real service to your community.*
  - a Relay weather-crop and market reports.
  - b Relay messages between relatives and friends.
  - c Free station to broadcast station reports.
  - d Give free demonstrations of the operation of receiving apparatus.

## The Radiophone Enthusiast Vs. the Radio Amateur

By L. W. Van Slyck  
Fifth Prize

(Opinion handed down by the higher court, and arguments as stated there, are here shown.)

The Radiophone Enthusiast (plaintiff) in court versus The Radio Amateur (defendant).

### JUDGE—PUBLIC OPINION.

The contentions of the plaintiffs are as hereinafter shown:

The chaos existing in the air has progressed to such a point that we, The Radiophone Enthusiasts, urgently request that steps be taken to control the situation insofar as is possible.

We are the new-comers—the group of people so often termed by the Amateur as "intruders" and "hogs of the air," and the like. We claim, as a body, innocence and ignorance of wrong-doing in the pursuit of our pleasures.

We claim the right to own and operate a radiophone receiver under the same reasoning which permits us to own and operate our automobiles. We are within the law in so doing. We have been given permission by our Government. We claim the right to enjoy our radio music and entertainment as we would enjoy our phonograph music or our lecture course. We are an integral part of the social life of the modern community, and as such, our rights should be recognized and respected.

We are launching our case against the Radio Amateur who persists in interfering with our innocent pleasure—the person who in most cases is overstepping existing laws governing radio communication, and who, as it appears, is usually not the type of investigating, hard working amateur which

(Continued on page 1696)

# A New Non-Interfering Detector Tube

This Rectifier With A Liquid Electrode Is As Sensitive As A Standard Tube In A Regenerative Circuit

**M**R. HAROLD P. DONLE, Chief Engineer of the Connecticut Telephone and Electric Company, has invented and recently made public a new type of vacuum tube which, although acting only as a rectifier, is as sensitive as an ordinary three electrode tube used in a regenerative circuit. The new tube which is a radical departure from the conventional Triode, employs a liquid electrode of sodium which is kept warm by means of a small resistance connected in series with the filament and fixed on the glass wall of the bulb as shown in the diagram, Fig. 1.

It has been found that by using the three element detector in the regenerative circuit, sensitivity is greatly increased, but if regeneration is carried more than a certain point, there is produced considerable signal distortion. Furthermore, the adjustments are very critical and such a circuit, particularly in the hands of an inexperienced operator, creates a great amount of interference for other receiving stations.

At the Institute of Radio Engineers where the new tube was recently demonstrated Mr. Donle said in his paper: "For several years we have conducted experiments on many different forms of detectors, and particularly upon detectors employing ionization of metallic atoms. This was a most promising field of development since such ionization was found to be readily controlled and stable. As one of the results of this work we have developed the present tube which is the logical result of experimental work which we have done along these lines. This new tube has none of the disadvantages of regenerative and gaseous detector systems above mentioned. Its method of operation seems to involve many interesting phenomena, which are radically different from those occurring in other tubes."

"The construction of one form of this tube is illustrated diagrammatically in Fig. 1 where F is the filament, A is the anode, which may be of metallic sodium in the

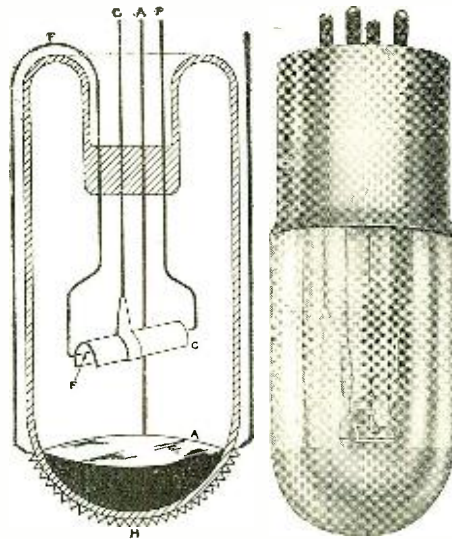

Figs. 1 and 2.—Photograph of the New Tube and Diagram Showing Internal Construction. The Tube Itself and the Resistance Heating the Sodium Are Enclosed Within Another Glass Bulb.

collector electrode of the tube and the other to a contact operating on resistance connected directly across the filament battery terminals. The remainder of the circuit is as used with any simple detector."

The adjustment of collector potential is the only one necessary for efficient operation other than the usual variation of capacity and coupling of the tuning circuit. The potential of the "B" battery is not at all critical and usually may be varied between ten and thirty volts without much effect on response.

As a detector this tube is remarkably sensitive, its adjustment is simple, and it is absolutely stable in operation. This extreme sensitivity is readily reproducible and permanent.

The response secured with this tube in a plain circuit equals in magnitude the response from a regenerator, using maximum non-oscillating regeneration. A regenerative circuit under this condition of critical adjustment will give very considerable distortion, which is particularly objectionable when receiving voice or music and which can only be eliminated by a reduction of regeneration and consequent reduction of signal strength.

On the other hand, the new detector creates no noticeable distortion, and, as it does not oscillate over its useful range, it cannot create any interference with other receivers. Furthermore, it is unaffected by small capacity changes, such as those produced by the operator's hand in tuning.

The response of the tube is greatly improved by very weak coupling between the circuits. This is due to its very low input impedance which also makes the proportion of capacity and inductance of secondary circuit for maximum results quite different from those for other tubes. Although the new detector can be used successfully in an ordinary two-circuit tuner, results will fall short of the maximum unless means are available for selecting the best value of secondary inductance.

In this tube there is an electron flow from the filament to the collector, the magnitude of this current being due in part to the relatively large area of the collector and to its close proximity to the filament. It, therefore, receives an equivalent of large electron flow when it is at the same potential as the negative end of the filament. In order to reduce this flow an opposing po-

tential (which may be taken from the "A" battery) is introduced into the circuit between collector and filament. This potential is called the neutralizing potential and is used as abscissas of curves shown in Fig. 4, which show the variation in anode and collector currents  $I_a$  and  $I_c$  with variation of neutralizing potential  $E_n$  and also the collector current when the anode circuit is open  $I_c^1$ . The curve labelled  $I_c - I_c^1$  is the difference between the collector current with the anode circuit completed and opened. This last curve is interesting in that it apparently takes into consideration various phenomena concerned in the operation, and its slope is practically a direct index of the merit of the tube as a detector.

These curves show some of the fundamental characteristics of the tube. The abrupt bend in the collector current at  $E_n = -1.8$  is a point at which maximum detection would be expected to take place, according to the usual conception of detection as being due to rectification over a section of the characteristic slope where the rate of change is large. One would also gather from this curve that the effect of a signal impressed would be to increase the average value of the collector and anode currents. Although some detection takes place on this part of the curve, in magnitude it is incomparable to that secured over the sensitive portion of the slope. The point of maximum sensitivity for these curves is at  $E_n = -1.4$  volts, which is at a relatively flat portion of the collector current curve and considerably above the lower bend. Furthermore, a signal impressed on the collector circuit always gives a decrease in collector current regardless of whether the characteristic curve at the sensitive point is concave or convex, many examples of both types having been observed. It should also be noted that this point of maximum sensi-

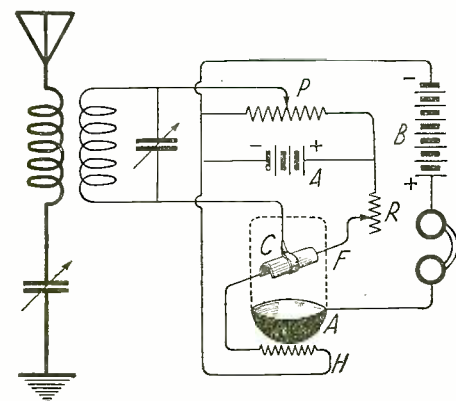

Fig. 3.—Hook-up of the New Rectifier Tube. Note the Resistance in Series With the Filament. The Current Consumption is About the Same as That of a Standard Tube.

bottom of the tube and H is the heater which is a short length of resistance wire cemented to the outside of the glass directly underneath the anode. This heater maintains the anode at proper operating temperature. C is the 'collector' electrode of sheet metal bent into a 'U' and positioned above the filament with its open side toward the anode. Fig. 2 shows a finished tube. In operation the tube may be connected to the circuit shown in Fig. 3, which is simply a two-circuit tuner with one terminal of the secondary connected to the

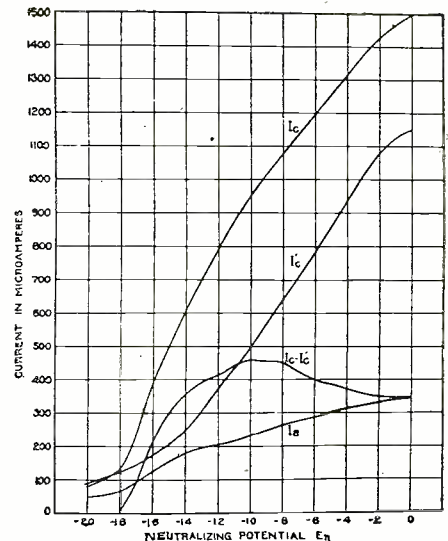

Fig. 4.—Variation in Anode and Collector Currents  $I_a$  and  $I_c$  with Variation of Neutralizing Potential  $E_n$ .

tivity occurs somewhat above the center of the  $I_c - I_c^1$  curve. Another point of interest in connection with these curves is the values at operating potentials of collector and anode currents, the collector current usually being two to four times that of the anode. Special attention should be given also to the large changes of current produced by small changes of neutralizing potential.

Fig. 5 shows the change in collector current for impressed signals of different wavelengths. The ordinates of this curve show



in micro-amperes the actual decrease in collector current caused by a signal of variable frequency, but of constant amplitude. This curve shows that the response for the particular tube on which this data was taken becomes small above the wave-length of 1,000 meters, and that below this wave-length detection increases rapidly. This might seem to indicate a limited wave-length band of operation for this type of tube, but the entire shape and position of this curve depends upon the relative potentials of the tube electrodes and upon their proportions and relative positions. It is possible radically to change this curve by a simple variation of the neutralizing potential. It is also possible by a proper selection of values to secure a serrated form of this curve of which Fig. 6 is a typical example.

The possibilities indicated by this curve in the elimination of interference are obvious.

When the alternating potential of a signal is applied to the collector circuit, the pulsation is impeded to a greater or less extent depending upon the amplitude and frequency of this potential. Furthermore, since the pulsation causes a build-up of average collector current, the effect of a signal in this circuit is invariably to reduce the average value of this current.

Since slow changes in the collector circuit current are reflected in the anode circuit, a decrease of the average value of the collector current will result in a like decrease in the anode current, but this occurs without any appreciable amplification. By experiment on large number of tubes the ratio of change of power in collector circuit to resulting power change in anode circuit was found to be approximately unity.

This lack of amplification accompanying the detection effects, makes it feasible to operate the tube with an indicating device, such as a telephone receiver, placed directly in the collector circuit instead of in the anode circuit as shown in Fig. 3. This is of interest, although results are not quite as good as with the normal circuit (Fig. 3), due to the fact that in the low impedance circuit, the high resistance of the receivers interferes with proper functioning. The anode circuit impedance is well suited to the standard telephones and transformers on the market.

With the telephones in the collector circuit the device might seem to be more or less the equivalent of a two-element tube, but the contrary is true, however, for with this connection, if the anode circuit is opened, no operation whatever will be secured, thus demonstrating that satisfactory operation depends upon the presence of this new anode circuit.

The action of this tube depends upon ionization produced by electrons emitted from the filament. It is, however, not the purpose of this short article to go into detail

beyond a description of some of the most interesting characteristics.

At first thought it would seem necessary to allow a considerable time after lighting the tube filament before the anode would become sufficiently hot. That is, however, not the case on account of the following most interesting phenomenon. When the filament is first lighted the anode receives a small amount of heat by direct radiation from the filament and there will be, even at this relatively low temperature, a considerable emission of particles from this anode. This emission will, however, decay with time, and in a period of possibly one hour it will have reached a small fraction of its initial value. However, with the external heater connected in series with the filament, as described above, when the filament is lighted the anode will commence to receive heat from this heater. Its effect in raising the anode temperature will be necessarily slow on account of the interposition of the glass wall of the tube, but the temperature of the anode is increased by this heater at a rate approximately correct to compensate for the decay of the initial

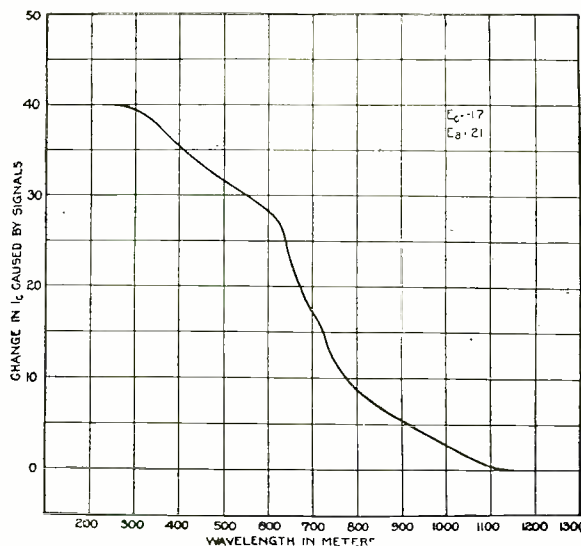

Fig. 5.—Curve Showing the Change in Collector Current For Impressed Signals at Various Wave-Lengths.

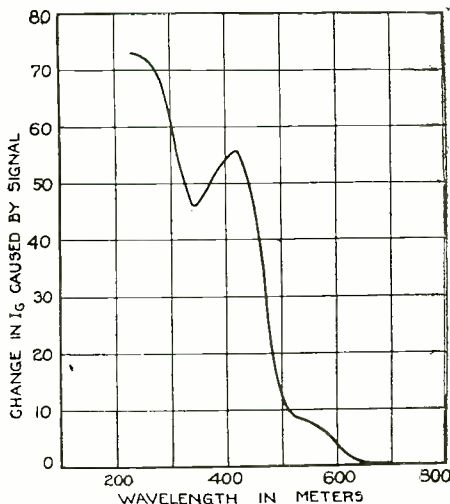

Fig. 6.—By Adjustment, it is Possible to Secure a Curve of This Shape. The Possibilities Indicated by This Curve in the Elimination of Interference Are Obvious.

emission, and thus the emission of particles from the anode will become fairly constant within a few seconds after the tube is first lighted. The result of this combination of affairs is that when the tube is lighted it

is almost immediately in operative condition, although in some cases a slight re-adjustment of neutralizing potential is later necessary to maintain a maximum sensitivity.

Ionization controlled in this way is extremely stable and these tubes may be maintained in their most sensitive adjustment for long periods of time. This is an impossibility with a gaseous detector. Also, with this type of ionization, it is possible to manufacture in quantity tubes with little if any variation of sensitivity. The tubes will remain substantially constant in sensitiveness throughout their lives.

It is felt that the unique characteristics of this device and its inherent advantages over prior detectors should offer a new avenue of approach to the problem of detection. By replacing, without loss of sensitiveness, many of the regenerators now in use, the new tube should further help to eliminate much of the present disagreeable interference.

### The Passing Of "NOF" As A Broadcasting Station

BY S. R. WINTERS

The radio-telephone broadcasting station NOF, the Anacostia Naval Air Station, at Anacostia, District of Columbia, ceased functioning as such on January 3, 1923. Originally established as a research laboratory devoted to studies affecting the problems arising from the use of wireless apparatus on board air craft, its facilities are rededicated to the primary object of its existence, since the above-mentioned date.

The concerts of the Marine and Navy Bands, as well as educational information originating with the Public Health Service, Veterans' Bureau, Childrens' Bureau, Bureau of Education, and Department of Commerce, and formerly broadcast by NOF, are now assigned for dissemination to NAA—the wireless station of the United States Navy Department at Arlington or Radio, Virginia. The dispensation of the services of the Naval Air Station as a Government broadcasting point automatically increases the burdens of NAA in this particular. The transmission of time signals, news items, crop and market reports, weather forecasts, naval business, communications for the Signal Corps of the United States Army, and occasional speeches of celebrities, are the items suggesting the variable services of this high-power radio-telegraph station. As recent as December 19, 1922, Representative Vincent M. Brennan of Michigan introduced a bill in the House of Representatives, which if favorably acted upon, would authorize the

(Continued on page 1742)

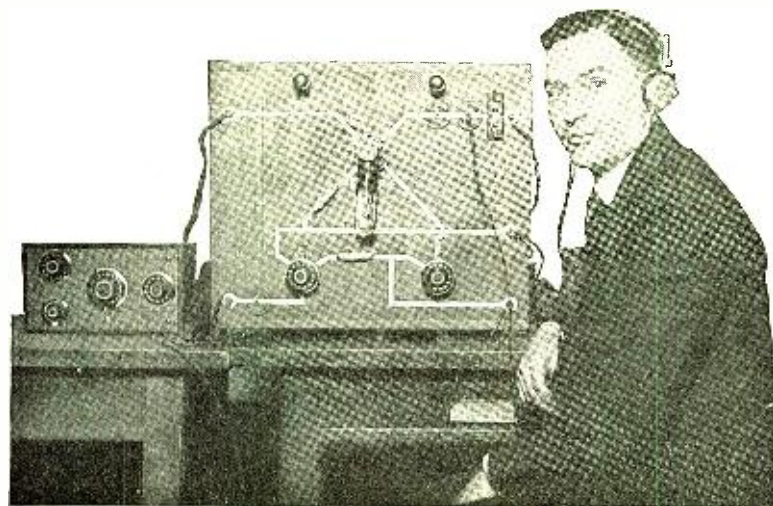

The Laboratory Set-up Used by the Inventor to Demonstrate the New Detector Tube. On the Left is a Two-Circuit Tuner and in the Center the Panel Supporting the Tube, Rheostat and Potentiometer. Each Wire is Outlined in White Showing the Hook-Up.

# The Radio Flivver

By STANLEY EDGAR

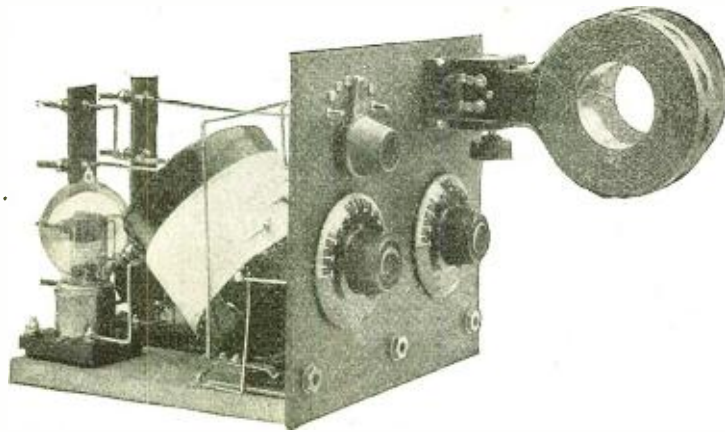

Fig. 1. A Striking View of the Unusual Compactness of the Radio Flivver Set. The Loop Is Three Feet Square. All the Apparatus Necessary for Operating the Set Is Shown in This Photograph. Photos courtesy Radio Guild.

THE expression "Flivver" as applied to a radio receiver, originated in the comparison made between the super-heterodyne and the single-tube super-regenerative receivers by the inventor of both circuits, Major Armstrong, in his address to the Radio Club of America last July. Major Armstrong reminded his audience that super-regeneration did not supercede all previous methods of reception and that the super-heterodyne, although it required eight or nine tubes to operate it, still remained the most efficient and easiest controlled method of amplifying short wave signals at Radio frequency.

In discussing the super-regenerative receiver, however, he explained that the same degree of amplification could be obtained by the latter method with only one or two tubes, although not with the same ease of adjustment. The Super-Heterodyne, then, was the "Rolls-Royce method of reception" but the Super-Regenerator was the "Radio Flivver."

An extremely interesting type of super-regenerative receiver is described as the Radio Flivver by Mr. Kenneth Harkness in a book published by the Radio Guild. The author has named this set "The Radio Flivver" because, for its size and cost, it probably accomplishes more than any radio receiver in existence. It is an extreme example of the extraordinary amplification which super-regeneration makes possible with a single vacuum tube and a very small amount of apparatus.

The set is wired as shown in Fig. 3. As indicated in that diagram and in the photographs, it is possible to receive on a loop and operate a loudspeaker by means of this small unit which requires only two vacuum tubes. It is claimed that the signals obtainable are astonishing. From our experience with the set, they are loud enough to be heard several hundred feet from the loudspeaker. It demonstrates in a convincing manner the enormous amplification which super-regeneration produces.

Fig. 1 shows a photograph of all the apparatus required to operate the Radio Flivver. The loop, batteries

and loudspeaker are all placed on a small table and the photograph clearly shows how small the receiver is when compared with the loop, which is three feet square, and the loudspeaker of a well-known type.

There are only four controls to the set and after two of these have been adjusted for a particular wave-length the amplification is controlled by the coupling between the two honeycomb coils and variation of the condenser across the loop.

In designing this set the object was to produce a super-regenerative receiver which, with one stage of audio-frequency amplification, would operate a loudspeaker with the least possible amount of apparatus in as compact a space as practicable and with the smallest possible number of controls.

To decrease the size of the receiver and reduce to an absolute minimum the number of controls, no filament rheostats were used, a fixed frequency of variation was employed and inductive coupling used between the grid and plate coils of the second feed-back system to produce the low frequency oscillations.

The filament rheostats were sacrificed in the Flivver set as they are not absolutely essential, especially with five-watt tubes. Inductive coupling is used between the two honeycomb coils to save the space and cost of the variable condenser and radio frequency choke coil of the capacity coupling system employed in other types of super-regenerators.

Fig. 2, a photograph of the receiver itself, shows the unusual compactness and simplicity of this remarkable set.

## THE CIRCUIT

If the wiring diagram of Fig. 3 is studied it will readily be seen that the Radio Flivver set consists of a single-tube super-regenerator with an additional tube for amplifying the output at audio frequency. When the telephones are plugged in the middle double-circuit jack, the audio frequency amplifier is cut out of the circuit.

The system of producing super-regeneration employed in this set has been discussed elsewhere. An ordinary regenerative circuit, with a strong feed-back coupling, is provided with a second feed-back system, represented in Fig. 3 by the coils L3 and L4, each shunted by a condenser. By means of this second feed-back system, self-generated oscillations of any desired frequency are produced in the circuits of the tube. The alternations of current produced by the oscillations of this second feed-back system introduce variations into the regenerative amplifying system. The plate voltage is increased and decreased at a constant frequency. Similarly, the resistance of the grid circuit of the regenerative system is periodically increased by the grid-filament current which takes place during the positive half of every cycle of the self-generated oscillations. These two variations take place at the same frequency but in proper phase relation.

The manner in which these variations of the regenerative system produce the enormous amplification of super-regeneration is rather complicated and will not be entered into at this time. The designer of the Radio Flivver set describes the theory of operation in considerable detail. In this explanation, however, it is made evident that this particular type of super-regenerator is only suitable for the reception of radio telephony, spark telegraphy and I. C. W. It is not suitable for the reception of straight C. W. telegraph now.

## APPARATUS USED TO CONSTRUCT THE RADIO FLIVVER

The following is a key to the circuit of Fig. 3 and shows all the apparatus used in the construction of this receiver:

- Ref. to Fig. 3. Article.
- L1 ..Vario-coupler Primary (50 turns, tapped every tenth turn)
- L2 ..Vario-coupler Secondary (100 turns)
- L3 ..Duo-lateral coil, 1250
- L4 ..Duo-lateral coil, 1500
- C1 ..Variable condenser, .0005 M. F.
- C2 ..Fixed condenser, .002 M. F.
- C3 ..Fixed condenser, .001 M. F.

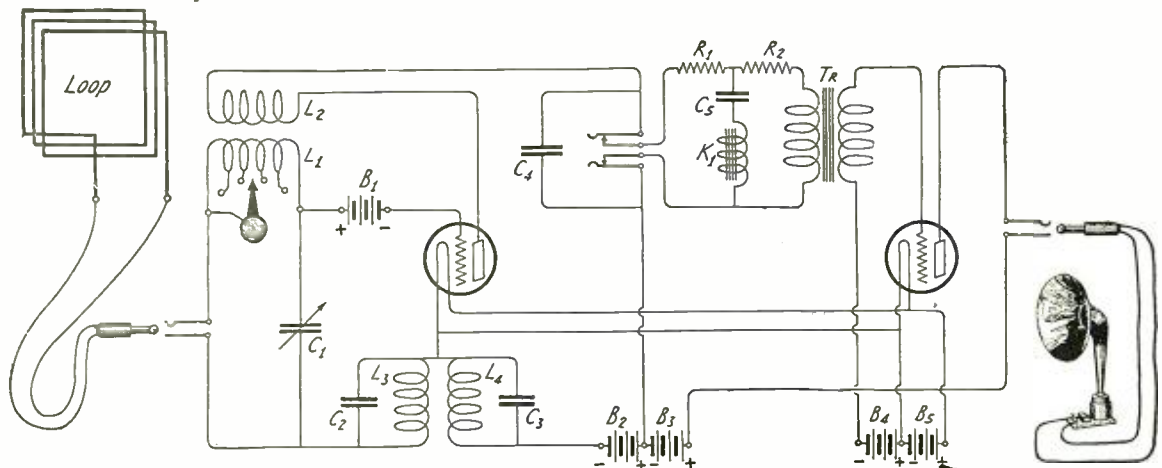

Fig. 3.—Hook-up of the Super-Regenerative Set Described Herein. The Second Tube Is That of the Audio Frequency Amplifier. The Grids of Both Tubes Are Impressed with a Negative Potential from "C" Batteries.

- C4 ..Fixed condenser, .005 M. F.  
 C5 ..Fixed condenser, .005 M. F.  
 R1 R2 ..Two 12,000 ohms non-inductive resistors  
 K1 ..Iron core choke coil (.1 Henry)  
 Tr ..Audio frequency amplifying transformer  
 B1 ..Variable grid battery 3 to 15 volts  
 B2 ..Plate battery, 150 volts  
 B3 ..Plate battery, 45 volts  
 B4 ..Grid battery, 22½ volts  
 B5 ..Filament storage battery, 6 volts  
 Loop Closed coil aerial  
 - ..Bakelite panel, 8"x9"  
 - ..Two bakelite binding-post strips, 7"x1"  
 - ..Two open circuit jacks  
 - ..One double circuit jack  
 - ..Switch set (switch lever, six contacts and two stops)  
 - ..Two telephone plugs  
 - ..Two vacuum tube sockets  
 - ..Eight binding-posts  
 - ..Wooden base, 8½"x8"  
 - ..Duo-lateral coil mounting  
 - ..Cabinet to enclose receiver  
 - ..Two dials  
 - ..Two vacuum tubes  
 - ..Loudspeaker

Standard materials of the values given above were used by the designer in the construction of this set.

The wiring is shown in detail in Fig. 3. The binding-posts, which were employed as the eight terminals of the batteries which appear in this diagram, were attached to two strips at the back of the receiver. These bakelite strips appear in the photograph of Fig. 2.

#### METHOD OF OPERATION

In operating the Radio Flivver it was found that five watt tubes gave the best results. With these tubes, 150 to 175 volts were used at the plate battery potential for the regenerative amplifying tube and sufficient voltage added to apply 200 volts to the plate of the audio-frequency amplifying tube in the manner shown in Fig. 3. Six or seven turns on a loop three feet square with ten or twenty active turns in the primary of the vario-coupler were found to be about the correct values for the reception of 360 and 400 meter waves. Close tuning of the loop and grid circuit is obtained with the variable condenser across the grid circuit.

The proper value of grid battery was found to be important. From 6 to 9 volts were used as the potential for the grid battery of the first tube while a 22½ volt biasing battery was employed in the grid circuit of the audio-frequency amplifying tube.

Referring to the photograph of Fig. 2, the upper left hand switch lever short-circuits portions of the primary inductance of the vario-coupler. When the proper adjustment for any wave-length is obtained, it is not necessary to again change the position of this switch.

The dial below the switch never controls the rotor of the vario-coupler and therefore controls the feed-back of the regenerative amplifying system.

At the upper right of the panel are the two large duo-lateral coils in their variable mounting. The lower right hand dial controls the condenser across the grid circuit and tunes this circuit to the frequency of the incoming signals.

To the amateur who is learning to operate a receiver of this type, it is suggested that he employ the size of loop and values of batteries given above and proceed as outlined below.

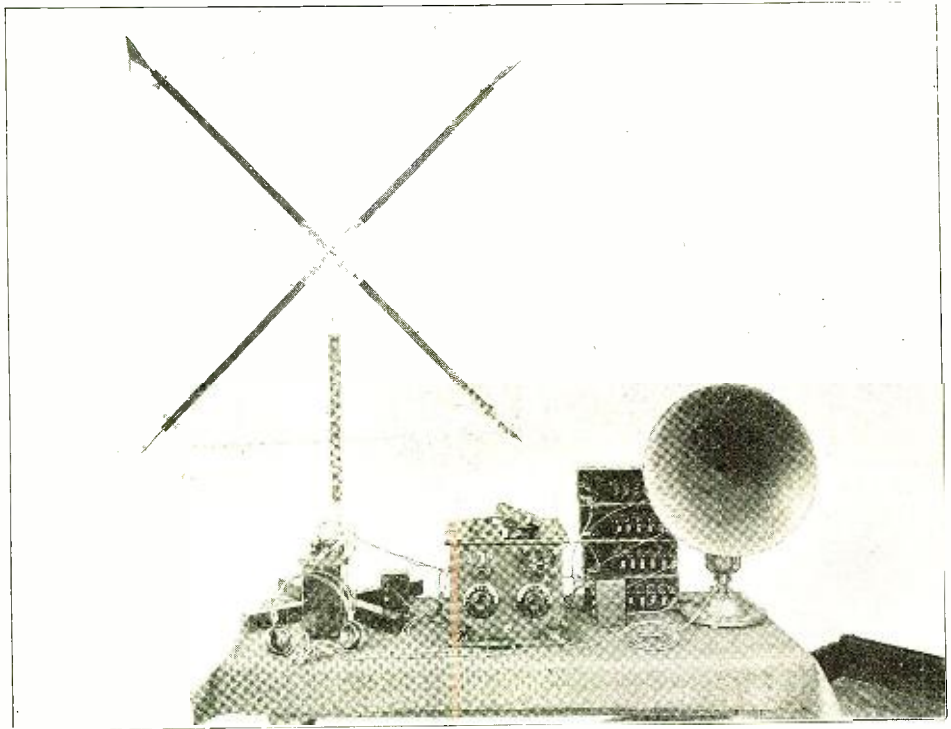

Fig. 2. A Close-up of the Radio Flivver, Indicating Its Extreme Simplicity. The Loop Is Plugged in the Left-Hand Jack and the Loudspeaker in the Right. Telephones May Be Plugged in the Center Jack to Cut the Audio Frequency Amplifier Out of the Circuit.

Plug the loop in the left hand jack shown in Fig. 2 and the telephones in the center jack.

Short-circuit all but ten turns of the primary of the vario-coupler with the switch lever.

Loosen the coupling between the duo-lateral coils until they are almost at right angles to each other.

Connect all batteries to the binding posts at the rear. A high pitched continuous whistle should immediately be heard in the phones. If this whistle is not present bring the two duo-lateral coils together and change the value of the grid battery B1 to start the oscillations.

The lower left hand dial, controlling the rotor of the vario-coupler should then be turned until a click and roar are heard in the phones.

Tests should then be made for reception on signals from a near-by station or a wave-meter.

Decrease the coupling of the regenerative system with the lower left hand dial. Then turn the right hand dial until the grid circuit is tuned to the frequency of the incoming signals which should be audible in the telephones. Increase the coupling of the regenerative system with the left hand dial until the point of maximum amplification of signals is obtained. Then gradually tighten the coupling between the two duo-lateral coils until a certain point is reached when great amplification takes place. Very careful adjustment of the coupling between the duo-lateral coils and the position of the rotor with the left hand dial should be made simultaneously to find the proper degrees of coupling.

If the telephones are then removed from the center jack and the plug from the loudspeaker inserted in the third jack the signals should roar in with terrific volume. It may be necessary to make minor adjustments to obtain purity of tone.

The operation of the Radio Flivver set requires some practice but a little perseverance is well rewarded by the extraordinary amplification it produces.

## A "B" Battery Fuse

By A. W. LAMBERT, Jr.

An ambition that most amateurs seem to lack is that of being appointed Coroner at the post-mortem of a burned-out tube, UV-200, and it is suspected that Dad will, particularly if the deceased is a favorite, demur at coughing up another five bucks for replacement.

The writer was present as chief witness at an inquest of this sort last year. Fortunately it was another's tube that gasped and gave up the ghost. And while the chief mourner gave vent to grief in his own peculiar way, the writer resolved to be careful, even though the experience didn't cost him anything.

One Sunday afternoon not long thereafter, while experimenting with several stages, each using a six-fifty bottle with several odd "B" batteries connected at intervals and in series about the set, this incident was recalled and it occurred to the writer that precautions had better be taken.

It had been his custom to remove all tubes before mixing up new connections, and re-test for high-voltage in the filament circuit before replacing the same. But with several tubes in the hook-up and frequent changes for comparisons, such precautions became a nuisance, so the writer decided to employ some fuse scheme as filament insurance.

Numerous filament protecting fuses are advertised, so with these in mind we looked for a bit of half-ampere fuse wire to put in the filament leads of the tube. However, as no such material was procurable on short notice a substitute was sought. It then occurred to the writer that such protecting devices were placed in the wrong position anyway. He reasoned that as any excess voltage must come from the "B" battery, why not forget the filament circuit and put the fuse where it really would protect,—in the "B" battery lead. In such a place a very small fuse would readily pass the few milliamperes supplied by this battery; and this fuse would blow long before the one-ampere current necessary to light the filaments would be reached, should the "B"

(Continued on page 1712)

# Heard But Not Seen



The Managing Forces of Stations WAAM, I. R. Nelson Co., and WBS, D. W. May, Inc. at Newark, N. J. This Merry-making Group is Well Known (By Ear) to the Radio Public and to Our Belief Arranges Exceptionally Good Programs that Appeal to the Majority, an Important Factor. We Have Never Heard the "Mascot" Announce, but Hope that He Will in the Near Future—if Only to Give Us the Thrill of the Open fields.

## Form A Radio Club By CHARLES A. REBERGER

ONE would not make himself liable to criticism were he to make the assertion that much of the success of amateur radio in this Country, is due to the radio club. The clubs have been a large factor in bringing wireless to its present day high plane of development. Many things that are worth while to the radio fraternity can be traced to the club. Good legislation, fair laws and general interest in wireless as a whole are all directly attributable to the radio clubs. They have reached a stage where they are deemed a necessary something that every amateur must have and something which no community or city can afford to be without.

It is essential that every person interested in radio belong to some organization. The amount of enjoyment he will derive is, to a large extent, dependent upon the club. The advantages in being a member are too well known and too numerous to require enumeration. There are very few who are not aware of this fact, too. Hundreds of radio clubs scattered all over the country are proof enough that they are valued. Anyone joining an association of this type immediately makes a good investment, for the profits are bound to be large. It is a known fact that in towns where wireless has waned, much of it can be traced to the failure of some club. Where radio is most successful will be found the active organization. No amateur is getting the most out of the game if he is not enrolled in some club. Its headquarters are very often the scene of many discussions

on subjects pertaining to radio, which would probably be more beneficial to the amateur than if he had read several pages of some

**WE ARE** glad to publish this article mainly for the reason that the status of radio clubs in the United States is a very wretched one, with the exception of about ten or twelve clubs, all of which are excellent.

We express the opinion that there are no more than twenty-five REAL radio clubs that amount to anything in the United States. The rest of the so-called "clubs" exist only on a piece of stationery, or, perhaps, in the imaginations of their founders, who get up the clubs merely as an advertisement and to get their names into various periodicals.

The great trouble with the American radio amateur is that he does not, as a rule, frequent clubs at all, and prefers to work out all his problems by himself. This is a situation that is a blemish upon the American amateur, and should be rectified.

A real radio club is a wonderful thing, but it must be one that actually exists and not one that exists on paper only.

EDITOR.

text book. It is really a wireless institute and sooner or later, during the course of its life, nearly every phase of the science will be thrashed out and many mysteries brought to light.

Generally speaking, a member gets more out of a club than he puts in. Upon enthusiastic and loyal members most often rests the greater portion of the burden placed for the success of the organization. It cannot be otherwise, but this fact is generally lost sight of by many of the less appreciative members of the club. Clubs make possible at a hardly noticeable outlay, what would be almost impossible, or at least only possible at a great cost. With a club, all members are expected to share in the expense of contributing toward buying apparatus, etc.

Clubs have a great responsibility. They should be something more than paper organizations, something more than mere "hang-outs." The men who direct its course should be selected with the utmost care and should be only those who have their hearts and souls in its success. They should be enthusiastic workers without the constant thought of remuneration before them and should be far sighted enough to realize that the proper functioning and progress of a club depends mainly upon them as well as the success of radio in their immediate localities.

On the other hand, much rests with the individual member. The fellow who thinks that he is doing his share by paying his

(Continued on page 1739)

# Broadcast Receiving and Receivers

By JOHN F. BRONT

FROM broadcast receiving stations there issue many complaints from the deep chests of irate listeners that the "rockcrusher" across the way, or the naval station further along, breaks up the concerts and makes the news and weather reports a mass of hieroglyphics. Much of the entailed fault lies within the receiver in use and not at the door of the rockcrusher. There are in some cases sound basis for complaint. Nevertheless the QRM can be often traced directly to the inefficiency and lack of selectivity of the receiver. The fault lies chiefly in the design and probably not to any inherent incapability of the listener.

Many broadcast listeners do not take into account that radio receivers in general are not designed to be heard all over the room. In commercial work especially, the radio operator has trained himself, as is proper, to receive signals when his receiver is adjusted close to such a point that the signals approach unit audibility. If insistence was made that received signals were as loud as possible, only a few stations could work at one time, which would slow up communication and impede prog-

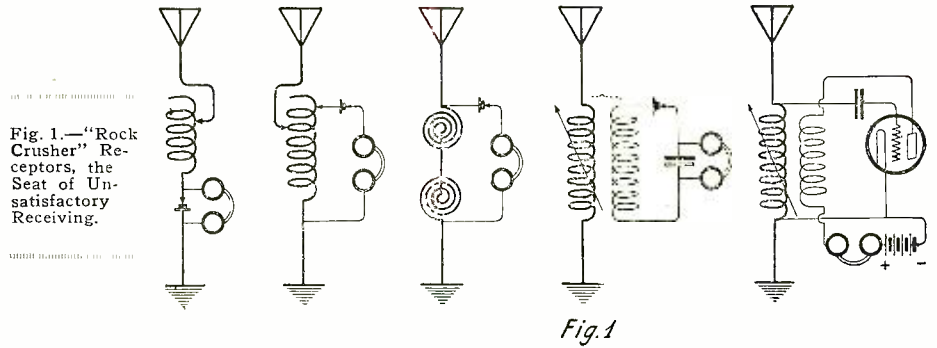

generally emphatic comment on the inhumanity and the downright cussedness of the rockcrusher. The damping of the nearby high power station may be very low and its operation according to law and Mr. Hoyle, yet there is interference.

One thing must be done. The coupling must be loosened at the receiver and brought to a point where the rockcrusher is excluded, if this is possible, which is not always the case when the audibility of the desired signal has been reduced by the

fication brings out the audibility of the desired signals to the desired point.

An honest critical survey of the receiving apparatus by the user may surprise him in the inefficiency of his own receiver. It is the case in many instances that the receiver itself is at fault. Take for instance the naval stations. Their transmitting decrement is limited by law as are all other stations at 2. The navy regulations further limit the decrement to .15. If the 400 meter receiver cannot tune a station out, the decrement of which lies in this quantity, there is generally something lacking in that receiver or in its manipulation.

In regard to many receiving circuits, they are not stiffened sufficiently to be at all selective. In some instances the actual decrement of the receiving set is so large as to retard proper selectivity, although the apparatus in general as far as the actual circuits employed are concerned, is efficient otherwise. In this regard, just for comparison imagine the difference in decrement between the "plain aerial" (phones and detector in series with antenna) and an aerial circuit composed of a high grade condenser and Litzendraht cable, with the phones in a secondary circuit. The first is of very high resistance (therefore decrement, within limits) with the crystal and phones which may amount to thousands of ohms. The tuning is very broad and any surge of energy either from static or from a multitudinous scattering of nearby stations will come rollicking down the antenna and through the phones in a mad bedlam.

In a proper oscillating circuit, there is a distinct limit which the resistance must not exceed. If the resistance is greater than twice the square root of the inductance in henries divided by the capacity in farads, there will be no oscillations. The point is this: the closer the constants of the circuit come to the limits imposed by the above formula, the lesser will be the efficiency of the tuning abilities of the receiver. One

(Continued on page 1674)

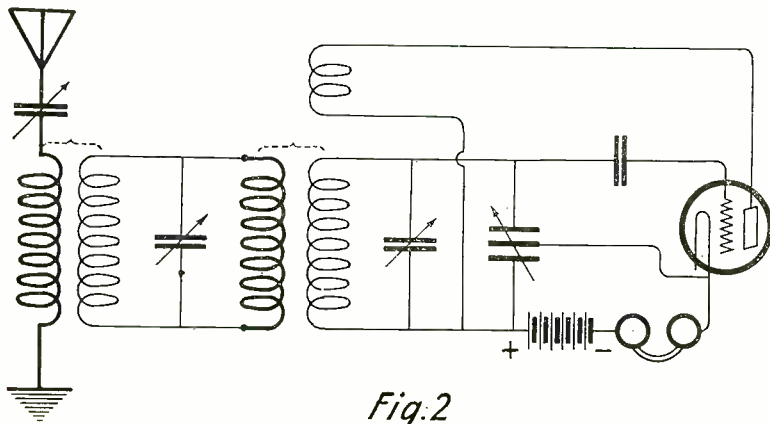

Fig. 2.—A Selective Receiver With Intermediate Circuit Which Gives a Sharper Tuning and Prevents Radiation from the Set.

ress. The same applies vitally in the receiving of concerts and other broadcasts from local stations by the novice or the advanced radio experimenter. In efficient receiving of radio signals, where a number of stations are working simultaneously, the circuits must be very loosely coupled and exactly tuned to avoid interference and static surges as far as is possible. With loose coupling is entailed a falling off in audibility. The average broadcast listener does not desire this. He wants his signals loud enough to be well received, so that possibly others may listen within a room. However, loud signals and avoidance of interference are generally incompatible. There is only one resort in general: selective tuning with amplification, if an out door aerial is employed.

It must be kept in mind that in a two circuit tuner, the signals are loudest when the incoming energy is equally divided between the primary and the secondary. That entails proper coupling and exact tuning. In tuning, the capacitive and the inductive effects of the circuits are so varied as to bring the effective reactance to a minimum for the frequency of the desired wave. The circuits then respond most efficiently to the signal desired. However, this latter may be of low amplitude and the reactance of the circuit may be less for a signal from a nearby high power station, sending out great energy at another frequency, than for the weaker signal which is the one desired. This condition entails QRM and

loosening of the coupling to a point where it is just audible. Further loosening of the coupling may drive out the unwanted signals completely, but it defeats the desires of the broadcast receiver because the broadcasted matter is inaudible. In this case the only resort is amplification, which will bring the broadcast signal back into the phones and, if the rockcrusher again is in evidence, the coupling must be further reduced and maybe further amplification added. This process may have to be repeated alternately until the rockcrusher is finally eliminated and the additional ampli-

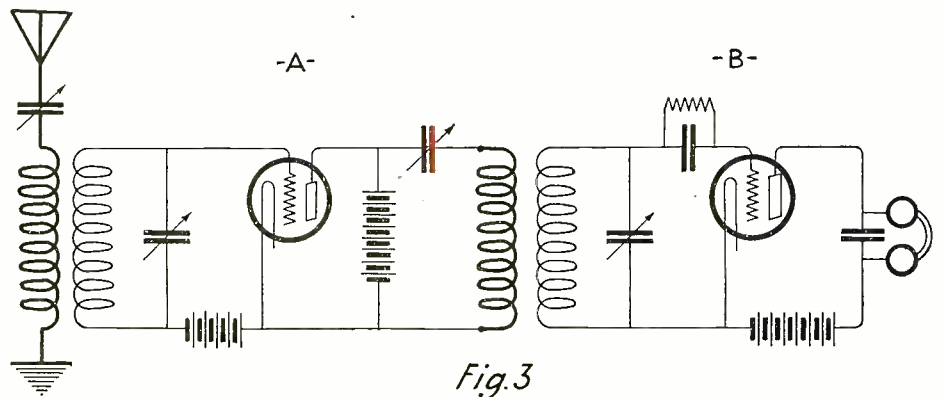
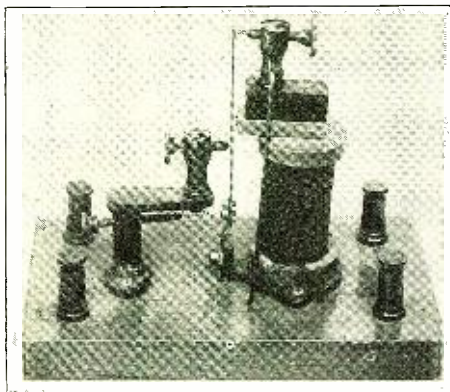

Fig. 3.—A Circuit for Selecting Desired A.C. Component of Desired Signal in Tube "A" Plate Circuit and Amplifying as Well as Detecting in "B."

# Controlling Models By Radio

By MAJOR RAYMOND PHILLIPS, I. O. M.

## Part II



Photograph of the Completed Relay as Shown in Fig. 8.

**I**N my first article I described apparatus and circuits suitable for use in connection with the wireless control of mechanism.

It was not expected that beginners would be able to sufficiently grasp the details of such circuits that construction of experimental apparatus could be commenced forthwith, so I am now going to write a new series of articles explaining (in the simplest possible language) how wireless-controlled working models can be constructed in an inexpensive manner.

If the instructions given are carefully followed, there is no reason why wireless enthusiasts should not achieve good results, and experiments in this connection will be found fascinating, amusing, and instructive. In my first article I mentioned that when constructing apparatus suitable for the wireless control of mechanism it was important to use a good "relay." Many readers will no doubt ask what is meant by the term "relay."

I had therefore better explain that a "relay" is generally described as an electro-magnetic instrument which, by the means of the impulses of received currents, opens and closes a local circuit.

### JUNCTION OF A RELAY

Quite apart from wireless work, relays are used for a variety of purposes. Some amateurs may ask why it is necessary to use a relay to open or close a local circuit, but I may here explain that it is sometimes impracticable to operate instruments except through the medium of a relay.

For instance, modern "burglar alarms" are generally arranged so that, even if connecting wires are cut, an alarm is immediately set going.

This is effected by means of what is known as a "closed circuit" system, which involves a relay (its electro-magnet wound to a high resistance, current consumption thereby being reduced to its finest efficient limit) connected to a battery, and so arranged that when such battery circuit is broken the relay armature is released, and the latter, making contact, closes another circuit, which, being connected with another, and usually more powerful battery, functions an alarm bell or other suitable apparatus.

By referring to Fig. 2 in my first article it will be observed that a coherer is shown connected to a relay, so that the latter may close another circuit to function an electric bell.

A coherer would be ruined if a heavy current were allowed to pass through same, but when used in conjunction with a relay the risk of damage to a coherer is obviated,

otherwise it is apparent that it would be a very simple matter to connect a coherer with a battery and ordinary electric bell. Figs. 1 and 2 show respectively "plan" and "side elevation" of two types of relays.

### SIMPLE TYPES

In Fig. 1 a relay is shown with its armature mounted upon a vertical arbor, and consists of a base A, electro-magnet BB, armature C, vertical spindle or arbor with pivot D, bar E for supporting pivot of arbor D, contacts FF mounted respectively upon bar S, and support H, adjustable stop I, tension spring with adjuster J.

In Fig. 2 a relay is shown with its armature mounted in a simpler and cheaper manner. It consists of a base A, electro-magnet B, contacts CC, armature D, armature spring E (delicate) attached to one pole of electro-magnet B, adjustable stop F.

The latter relay is inexpensive to construct and can be connected up in the same manner as described for the relay shown in Fig. 1.

In connection with the construction of wireless-controlled working models (which I shortly propose to describe) I shall furnish constructional details, also diagrams showing the two types of relays referred to in this article, and which are suitable for operating a simple "selector." The latter will be ar-

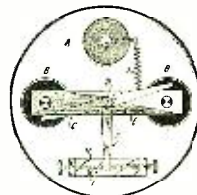

Fig. 1.—Top View of the Relay.

ranged to "open" or "close" circuits as desired, so that interesting effects can be produced.

I hope I have now made it quite clear as to the reason why a relay is necessary for the operation of certain types of instruments and apparatus. It will be understood that the diagrams illustrating the relays referred to in this article are not intended to be used as "working drawings," but merely to show the two types, of which full details will be furnished in subsequent articles.

Wireless enthusiasts will understand that it is not advisable, nor practical, to pass heavy currents through the contacts of a delicate relay, otherwise the instrument may be seriously damaged.

### SUITABLE FOR EXPERIMENTS

In such a contingency it is better, and, in fact, necessary, to install a supplementary relay, or relays. The latter may be provided with "mercury cups" instead of the usual delicate contacts.

The contacts of a delicate relay may be arranged to open or close a circuit connected with the electro-magnet of another relay, and the contacts of the latter may be so designed that circuits carrying heavy currents may be opened or closed as desired.

It will be understood that the relays shown in Figs. 1 and 2 (whilst quite reliable in their action) are only suitable for use with "short range" experimental apparatus, such as model airships, motor-boats, etc.

Another form of relay is called a "polarized" type. This is a very sensitive instrument, but, besides being somewhat costly to purchase, its construction should only be attempted by a skilled mechanic.

I, therefore, do not propose to give a description of such an instrument, but perhaps it may interest amateurs if I describe its mode of action, which is as follows:—

A permanent steel magnet (forming part of the instrument) is mounted in such a position that it magnetizes the extremities of the iron cores on which the bobbins are wound. A thin "tongue" of soft iron is mounted, and free to move between these polar extremities, and becomes magnetized in a contrary sense to the cores.

When the winding of such a relay is traversed by an electric current, the magnetization of one core is increased and that of the other decreased, so that the soft iron "tongue," finding itself in a kind of unstable equilibrium between the two polar extremities, becomes attracted by one pole, and such "tongue" being fitted with a suitable contact is arranged to open or close a circuit connected with a local battery.

From the foregoing description it will be apparent that a "polarized" relay would be a complicated instrument to construct.

As wireless enthusiasts sometimes ask questions which clearly indicate that many, apparently, still imagine it is possible to wirelessly transmit electrical energy to function electric motors and other mechanism. I shall first describe a simple method of wirelessly controlling a model electric train, so that such readers as may not have understood my previous article will now readily understand that at present it is only possible to control a "source" of electrical energy.

A model electric train can be wirelessly controlled by either controlling a source of electrical energy actually carried on the train, or that connected with the rails upon which the train runs. In the former case it would be necessary for the train to be provided with an electric battery such as an accumulator.

The train would thus be "self-contained," and would need no connection with a conductor rail conveying an electric current.

My well-known wireless-controlled airship—which, at the time of its introduction, was the first airship in the world to be wirelessly controlled before an audience in a theater or music-hall—had to be self-contained, in that it carried in a receptacle at the rear of the ship its own source of power in the shape of an electric accumulator,

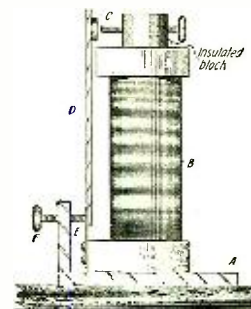

Fig. 2.—Side Elevation of the Relay.

### TYPES OF MOTORS

Model electric trains are generally arranged so that the source of electrical energy is connected to a conductor or third rail, and also to the rails upon which the train runs. As the latter type of model can be purchased in a standard form, generally complete with rails, at prices varying from \$5 to \$20—except battery, which is generally extra to the price quoted—and as the wireless control of the source of power involved with such models presents no difficulties, I should advise a beginner who desires to make a wireless-controlled model electric railway to purchase an electric train with rails complete, and confine his energies to making the wireless transmitting and receiving apparatus

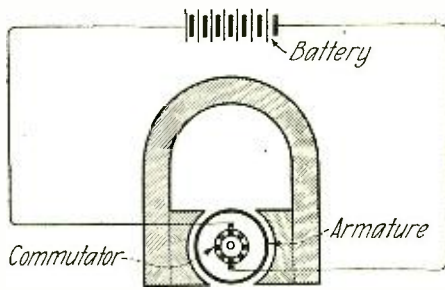

Fig. 3.—Model of Electric Motor With a Permanent Magnet Field.

suitable for controlling the model in question.

It will be well, when purchasing a model electric locomotive, to ascertain that the field magnet of the electric motor fitted to same is of "permanent magnet" type.

I had, perhaps, better explain that the term "permanent magnet" refers to one which retains its magnetism similar to the "horse-shoe" or "bar" permanent magnets generally so well known to amateurs. An electric motor with a permanent field magnet simplifies matters considerably, as a reversal of the motor can be effected by simply reversing the polarity of a circuit connected with same.

For instance, if the positive terminal of a battery was connected to the conductor or third rail, and the negative terminal of such battery to the outer rails of a model electric railway, the model locomotive would run in one direction; but by connecting the positive terminal to the outer rails and the negative terminal to the conductor or third rail, the locomotive would run in a reverse direction (due to a reversal of polarity in the armature of the motor). Thus the model could be made to run backwards or forward, as desired.

**POWER SUPPLY**

A wound field magnet would involve complications, and for small, inexpensive models is really not necessary.

Figs. 3 and 4 show respectively model electric motors with a permanent and wound field magnet. The latter motor is shown "series" wound, which means that the field magnet winding is in series with the armature—or, in other words, electric current passed through the field magnet winding is also compelled to pass through the armature windings. This type of motor is suitable for traction purposes, on account of its high starting torque.

Perhaps I had better explain that the term "torque" refers to a force which tends to produce torsion around an axis.

Another point to be considered when purchasing a model electric locomotive is to ascertain that the electric motor fitted to same is suitable for working with an E.M.F. of four volts. This means economy.

An accumulator with two cells coupled in series and made up as a complete unit, will provide the necessary voltage, or pressure; but it will be advisable for the accumulator to have a capacity sufficiently large to enable the model train to be worked without having recourse to continual re-charging of the battery.

I would, therefore, recommend amateurs to purchase a battery with an ignition capacity of not less than 40 ampere hours or 20 actual ampere hours.

Now the term "ampere hour" is a unit of quantity equal to the amount of electricity transmitted by one ampere flowing during a period of one hour, so that 40 ampere hours' ignition capacity generally means that an accumulator should be capable of maintaining an intermittent discharge of one ampere for 40 hours, or the same current continuously for a period of 20 hours. The latter referred to as the "actual" capacity.

Some batteries are capable of maintaining a very heavy discharge for one hour, but such are specially made for that purpose.

Having now described the electric train and its component parts, the next apparatus to be considered is the wireless equipment for controlling the model.

For transmitting purposes the modified form of Hertz oscillator, as shown in Fig. 1, of my last article, can be used. But for those who find a one-inch spark coil too expensive to purchase, a small ignition coil will do. These can generally be purchased at a very reasonable rate.

A suitable key should not cost more than \$2, and the remaining materials to complete the transmitter, i.e., balls, rods, supports for rods, and base board, for, say, \$2.

An amateur should be able to make the base board and assemble the various parts. A battery similar to the one described in this article should be used for supplying electric current to the transmitter.

Those who possess a tube receiver for listening in can use their battery which provides electric current for the filaments of the tubes.

I used such a transmitter to control mechanism—including that connected with my well-known wireless-controlled airship—which was exhibited during my lectures and demonstrations at the recent International Radio Exhibition and Wireless Convention, Central Hall, Westminster, London.

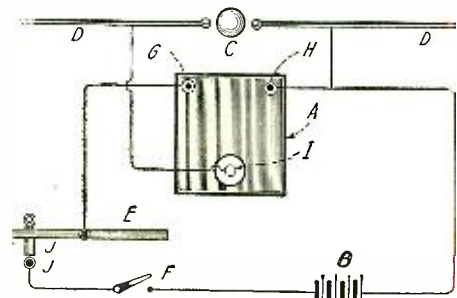

Fig. 5.—A Diagram of Circuit and Apparatus Suitable for the Transmitter in Question.

The fact that ignition coils are generally fitted with three instead of the usual four terminals—found on other types of small spark coils—appeared to puzzle many amateurs who attended my lectures, until—with the aid of a blackboard and explanatory diagrams of circuits—I explained the construction of such coils.

The transmitter when completed will be found quite suitable for controlling the wireless-controlled electric train receiving apparatus, which will be described in subsequent articles. Fig. 5 shows a diagram of circuits and apparatus suitable for the transmitter in question.

It consists of an ignition coil A—the trembler fitted to the coil is not shown—battery (4 volts) B, spark gap C, antenna rods D D, Morse key E with contacts J J, switch F, terminals G, H, and I.

It will be observed that the primary winding of the ignition coil is connected to terminals G and H, whilst the secondary winding is connected to terminals H and I.

In operation it will be apparent that on depressing the Morse key E (closing contacts J J) and closing switch F, electric current will flow from the battery B through

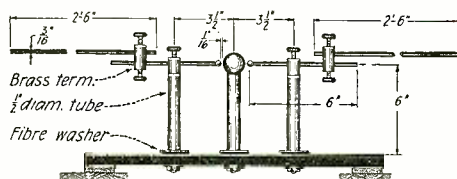

Fig. 6.—Details of Construction for the Spark Gap Used With the Transmitter of Fig. 5.

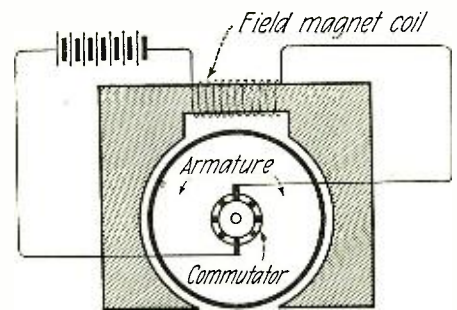

Fig. 4.—Motor With a Series Wound Field Magnet.

the primary winding and trembler—the latter not shown—of ignition coil A, causing a high potential discharge to jump across the spark gap C from the secondary winding connected with terminals H, I and antenna rods D D, thus causing etheric or wireless waves to be radiated from the latter.

The construction of such a simple form of transmitter presents no difficulties, as the principal component parts can be purchased ready made.

For the spark gap three brass balls will be required, two of which may be either 1/2 in. or 3/4 in. in diameter. The other may be 1 in. in diameter.

For efficient working of the transmitter these balls should be kept clean and polished, more especially at the point where the spark discharge takes place.

The spark gap can be mounted upon a baseboard as shown in Fig. 6.

The baseboard can be made of 3/4-in. white pine, with two lathes 3 in. wide by 3/4 in. thick secured at either end. The latter will prevent the baseboard warping, and, at the same time, admit of nuts and washers being used under the board to secure the various components mounted thereon.

The baseboard should either be shellac varnished or french polished. An ordinary switch—as used for electric-light installations—will suffice for opening or closing the primary circuit of the ignition coil, which together with a Morse key can be mounted in any convenient position on the baseboard.

Two lengths—each 18 in. long—of high-tension flexible wire will be required for connecting the secondary terminals of the ignition coil to the antenna rods, as shown in Fig. 5.

The outside diameter of the rubber insulation of such wire should not be less than 3/8 in.

For connecting up the primary circuit of the transmitter, flexible cord—such as that adopted for electric-light installations—may be used.

The conductors of the flexible cord should be composed of 70, or, better still, 130 strands of No. 40 gauge high conductivity copper wire. The two small balls forming part of the spark gap should be so adjusted that there is a clearance of not more than 1/16 in. between the large center ball and each of the smaller ones.

Referring to Fig. 6, it will be observed that the antenna rods are supported by terminals attached to rods, the ends of the latter being preferably screw-threaded to engage in the corresponding female screw-threads in the small brass balls.

The terminals in question can be easily "made up" by simply soldering together two large standard terminals, but those amateurs who possess a lathe will easily be able to make the appliances as shown.

Large standard terminals can also be used for connecting to the ends of the brass rods which are inserted in the ebonite or vulcanized fibre tubes, the latter being 1/2 in. outside diameter as shown.

Better insulation of the supports for the spark gap could, of course, be obtained by using solid ebonite or vulcanized fibre rods, instead of tubes as described. The former

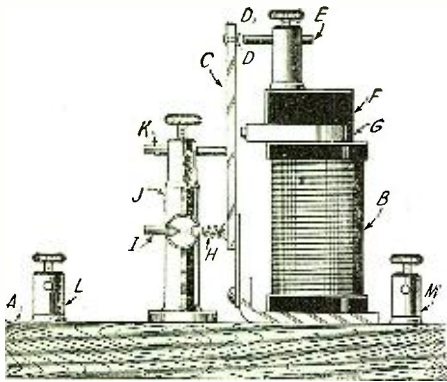

Fig. 8.—Details of the Completed Relay.

method would involve boring holes and cutting female screw-threads in the ends of the rods in question, also fitting screw-threaded studs to same; or male screw-threads could be cut at the ends of the rods. In either case the general arrangement would be the same.

The method I have described appears to be the simplest, and is quite satisfactory in general use.

I want to advise amateurs to be careful, when securing an ignition coil to the base-board as described, that screws are not used in such a manner that damage may be done to the condenser, or the secondary winding of the coil. It is better to make a suitable clamp of brass strip 1 in. wide by 1/16 in. thick, and secure the coil to the base-board as shown in Fig. 7.

The receiving apparatus for use in connection with the wireless control of a model electric train will consist of a coherer, relay, simple selector (i.e., selection by sequence), and switch, the latter for opening and closing the circuit connected with a coherer. Current for the coherer circuit will be supplied from an ordinary 3 1/2-volt pocket-lamp battery.

The antenna, or aerial, will consist of two aluminum, brass, or copper tubes, 2 ft. 6 in. long by 5/16 in. outside diameter, the same as those fitted to the transmitting apparatus described previously.

**MOUNTING THE RELAY**

The relay is a simple and inexpensive type, and I am now going to furnish diagrams, together with such elementary instructions that practically any amateur should be able to undertake the construction of same. Fig. 8 shows the relay complete.

It consists of a base-board A, electro-magnet B, armature C with contacts D and D1 (the latter being adjustable, as shown at E), vulcanized fibre block F, soft iron shoe G, armature balance spring H with adjusting rod I, supporting pillar J with adjustable rod K, four terminals L, M (i.e., two at each end of the base-board A).

The base-board A should be made of white pine 5 in. long by 3 in. wide by 5/8 in. thick. It should be either shellac varnished or french polished, and four terminals fitted as shown in Fig. 9.

The electro-magnet B (as shown in Figs. 8 and 10) consists of a wound boxwood bobbin, a Swedish charcoal soft iron core 2 in. long by 5/8 in. diameter, riveted to a soft iron base (or it can be secured to the base by means of an iron screw) and fitted with a soft iron shoe, also vulcanized fibre block and contact rod.

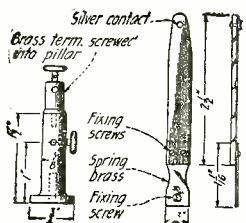

Figs. 11-12.—Constructional Details of the Armature and Main Binding Post.

An old silver watch-case bow will, if straightened out, make a good contact, and a small piece should be forced into a hole drilled in the contact rod D1; or, if sufficient is available, the silver rod itself may be used for a contact.

The armature C (as shown in Figs. 8 and 11) consists of a piece of Swedish charcoal soft iron 2 1/2 in. long by 3/8 in. wide by 1/16 in. thick, tapered, and fitted with a piece of spring brass No. 28 gauge, and a silver contact riveted at one end as shown.

A small piece of silver rod cut from an old silver watch-case bow will also do for this contact, which latter should be filed smooth after riveting in order to present a good contact surface.

The boxwood bobbin of the electro-magnet should be fully wound with No. 34 gauge single silk covered copper wire. It will be necessary to purchase about a quarter of a pound of the wire in question.

Winding should be commenced by passing the wire through a hole in one flange of the bobbin (as shown in Fig. 10). The latter can be mounted upon a mandrel in a lathe, whilst the bobbin or reel (upon which the wire is wound when delivered from the makers) can be mounted upon any suitable spindle, and arranged in such a manner that the reel can revolve freely. The wire can then be guided by hand.

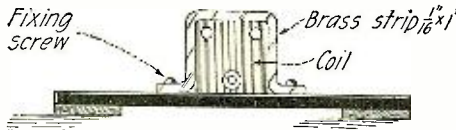

Fig. 7.—Means of Securing the Coil to the Base-Board.

After winding the first layers of wire, a piece of silk should be placed over the leading-in wire to obviate any possibility of its short-circuiting with subsequent layers.

Great care must be exercised in winding, more especially with the silk covering of the wire, which is easily damaged if carelessly handled.

Those amateurs who do not possess a lathe can easily rig up a mandrel fitted with a crank handle, so that winding the bobbin should not present any difficulties.

I have often rigged up a moving picture film rewriter for the purpose.

When the bobbin is fitted with wire the end of the latter should be secured by passing it twice under the last single coil.

Fully six inches of spare wire should be left at each end of the winding, so that it can be coiled up and connected to terminals as required.

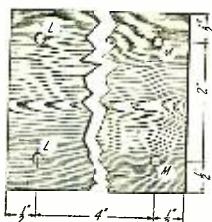

Fig. 9.—Dimensions of the Relay Base-Board.

**OTHER PARTS**

Those amateurs who do not mind the extra trouble involved could make a neater job of the winding, and also render the terminal wires of the latter less liable to breakage during handling, by soldering to such terminal wires (and afterwards insulating the joints) a short length of No. 22 gauge double-silk covered copper wire.

The lead-in with the larger gauge of wire would then be passed through the small hole in one of the flanges of the bobbin, and sufficient space being left, the last layers of the fine wire could first be wrapped with a layer of paper coated with paraffin wax, and then the larger gauge of wire used for winding the finishing coils.

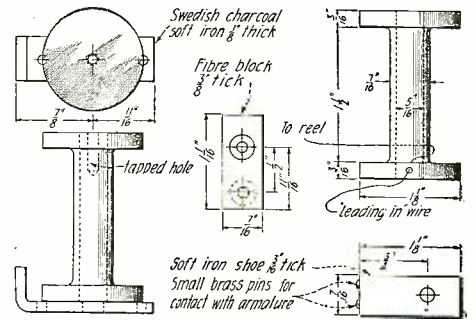

Fig. 10.—Dimensions of the Relay Bobbin.

The other component parts of the relay are shown in Figs. 8 and 12.

These simply consist of a standard terminal screwed into a threaded hole bored in a pillar of brass 1 1/2 in. long by 3/8 in. diameter, with two adjusting rods as shown. One of the latter is fitted with a spiral spring made with No. 30 gauge hard drawn brass wire.

This provides the necessary balance for the armature C shown in Figs. 8 and 11. When all the component parts are made as described the relay will be ready for assembling. This should be effected as shown in Fig. 8.

The two terminal wires from the electro-magnet B should be connected with the two terminals M fitted at one end of the base-board A.

A short length of No. 20 gauge double silk or double cotton covered copper wire should connect the terminal securing contact D1 with one of the terminals shown at L on the baseboard A. The other terminal should also be connected with similar wire to the soft iron base of the electro-magnet B.

The armature C (shown in Fig. 8) should be so adjusted that the clearance between it and the soft iron shoe G is not more than 1-16 in. The contacts D and D1 can also be adjusted accordingly.

In operation it will be apparent that when the two terminals M are connected with a battery, current from the latter will flow through the windings of the electro-magnet B, causing same to attract its armature C, and closing contacts D and D1, so that current from another circuit connected to the two terminals L could flow through such contacts.

In subsequent articles I shall furnish diagrams, and simple instructions for constructing other apparatus required to complete the wireless receiver in question. I shall also in due course furnish a diagram showing the complete wireless receiver together with the circuits involved.

(To be continued in next issue)

**Single-Circuit Receivers**

MUCH has been said about the "single-circuit" receiver; and not a little of it is extremely derogatory. It is not the purpose of this article to discuss the relative merits of the single-circuit receiver as compared with the inductively coupled type. Rather, it is intended to point out various means of utilizing such an instrument effectively, in the forms most commonly used by the broadcast listener. The comments in the following apply chiefly to the regenerative receiving instruments of this class.

It is all too frequently assumed that, because of its so called simplicity, no particular knowledge or understanding is necessary to obtain the best results from the single-circuit receiver. The writer has encountered very few novices whose results could not be greatly improved by an acquaintance with a few principles of receiver operation; difficulties attributed to all sorts of obscure causes have been obviated without recourse to anything further.

(Continued on page 1720)



# Radio Digest

## RADIO IN THE MINES

Tests conducted at the experimental coal mine of the Bureau of Mines at Bruceton, Pa., hold out the hope that wireless waves may be used in the future as a means of effective communication between rescuers on the surface and miners entombed in mines following fires and explosions. These preliminary experiments of the Bureau of Mines, made in cooperation with the Westinghouse Electric and Manufacturing Company, while failing to develop any practical method of using wireless waves for underground communication, nevertheless indicate clearly that electromagnetic waves may be made to travel through solid strata. In the Bruceton experiments, signals were heard distinctly through 50' of coal strata, although the audibility of intensity with distance is very great for the short wave-lengths used in these tests.

Longer wave-lengths are known to suffer less absorption and may possibly be found practically effective under certain conditions.

The mine telephone has been perfected to such an extent that it is giving satisfaction in most mines where the wiring is well insulated. Very often the telephone cannot be depended upon on account of falls of rock, grounding due to worn insulation or extreme dampness. In the event of a disaster it frequently happens that the mine telephone system is put out of commission by the agency that causes the disaster, at the time when it is most urgently needed. On this account the mining industry is interested in any kind of telephone system that can be counted upon in an emergency. Many requests have been received by the Bureau of Mines to devise means of utilizing wireless methods for this purpose.

The preliminary experiments consisted first in receiving signals from without the mine by means of a receiver located inside the mine, and second, both sending and receiving messages underground through the strata. It was found that with a receiving instrument set at a point 100' underground, signals from KDKA station, East Pittsburgh, Pa., could be heard distinctly. Station KDKA is at a distance of about 18 miles from the experimental mine. About 50' from the receiving station used in this test was a 6" bore-hole from the surface, lined with iron pipe and containing electric light wires which extended therefrom throughout the mine. The presence of these wires evidently assisted greatly in the reception, for when the receiving set was carried to another point in the mine removed from wires and tracks the signals were barely audible through 50' of cover. The fact that signals were detected, however, even though faintly, is sufficient evidence of transmission through the ground to encourage further experimenting.

In sending waves underground, a transmitter was used in such a manner as to send out continuous waves of 200 to 300 meters in length. On account of the limited time at disposal, no attempt was made to modify the apparatus in such a manner as to produce waves of greater length. Such additional experiments are much to be desired. In all experiments the vertical antenna was found to give the better results. The horizontal antenna gave practically no reception. A loop of a single turn was used with fair results. All these experiments were tried with a wave-length of 200 to 300 meters, except the reception from KDKA, which

was 360 meters. The strata at the Experimental mine lie almost horizontal. The direction of strata may have some influence on the transmission of radio waves, but the present experiments give no conclusive evidence on this point. No doubt the degree of wetness of the strata influences the transmission of radio waves. The Experimental mine is a comparatively dry mine, but the overburden is damp and a small stream of water is continually flowing from the mine. This overburden consists chiefly of soil and soft shale. The underground workings of the Experimental mine follow a horizontal 5' vein of bituminous coal, and the transmission and reception inside the mine followed the course of this vein.

Details of these experiments are given in Serial 2047. "Experiments in underground signalling with radio sets," copies of which may be obtained from the Bureau of Mines, Washington, D. C.

## Radio Articles Appearing in the February Issue of Science and Invention

Radio Controlled Mystery Ship, By Graser Schornstheimer, Naval Expert.

Motion pictures Via Radio, By Joseph H. Kraus.

Honorable Mention Awards in the \$300 Simplest Radiophone Contest.

New and Old Uses for Audion Amplifiers, By H. Winfield Secor.

Storage "B" Batteries, By John M. Dodendorf.

Broadcast Station Photos.

Broadcast Radiophone Station Call Letters Up to Date.

Radio For the Beginner—No. 12.—Selectivity, By Armstrong Perry.

Radio Oracle.

## SCHVEVENINGEN RADIO STATION BEING IMPROVED

The Government of the Netherlands is enlarging the present radio station at Scheveningen, which will be ready for operation early in 1923. It is designed to communicate with all parts of Europe and will be equipped for wireless phone broadcasting as well as telegraph transmission.

## WGY HEARD ACROSS ATLANTIC

WGY, the General Electric Company's radio broadcasting station in Schenectady, N. Y., has successfully transmitted a musical program across the Atlantic Ocean, according to word received from Dr. W. R. Whitney, director of the company's research laboratory who is traveling abroad.

Dr. Whitney states that he talked with Chief Radio Operator Black of the S. S. "America," who stated that while the ship was docked in Cherbourg, France, he picked up an entire evening's program from WGY and that the signals came in so clearly that when he laid the phones on his table the music was audible in the radio cabin.

## BRITISH REGULATIONS GOVERNING RADIO RECEPTION

### Conditions Which Broadcast Receivers Should Fulfill to Obtain Post Office Approval

1. That all types of broadcast receivers may be constructed for the reception of signals of any wave-length.
2. That the apparatus shall be so constructed, it is difficult to change the arrangement of the circuits embodied in the design by means of external connections.
3. The following units, each of which must consist of apparatus assembled connected and mounted in a single container, shall be approved:
  - a. Combined Tuner and Rectifier.
  - b. Combined Tuner, High Frequency Amplifier and Rectifier.
  - c. Audio Frequency Amplifier (of Valve or other type).
  - d. Tuner, Rectifier and Audio Frequency Amplifiers.
  - e. Tuner, High Frequency Amplifiers, Rectifier and Audio Frequency Amplifiers.

In particular, it is intended that each panel must contain all the high frequency circuits and the High Frequency Amplifiers in association with the Rectifier, but there is no limit to the number of high frequency or audio frequency amplifiers that may be included in any unit or set provided the other conditions set forth herein are complied with. Audio Frequency Amplifiers may be added in single, double or multiple units to (a) and (b).

4. No receiving apparatus for general broadcast purposes shall contain a valve or valves so connected as to be capable of causing the aerial to oscillate.

5. Where reaction is used on to the first receiving circuit it must not be adjustable but must be fixed and incapable of causing oscillation.

6. Where reaction is used between a second or subsequent valve on to the anode circuit of a valve connected to the aerial, either directly or inductively, and no specific coupling tending to produce oscillations in the aerial is provided between the first receiving circuit and the first anode circuit the reaction may be adjustable.

7. Tests of sets will be made on two aeri-als, one 30' long and the other 100' long. On these aeri-als the sets should be capable of receiving wave-lengths covered by the "Broadcast" band, viz., 350 to 425 meters.

8. The sets will be tested for the production of oscillations in the aerial and for interference properties with a factor of safety, i.e., increasing the high tension battery by about 30 percent, changing valves, etc., but not by altering any soldered connections.

9. The Postmaster-General must be satisfied that sets containing reaction can be reasonably repeated with consistent conditions.

10. After approval the type will be given a Post Office registered number and makers must see that the sets fulfill the non-interfering conditions before they are sold. All sets sold for use under the Broadcasting Receiving License shall bear the registered trade-mark of the British Broadcasting Company and the Post Office registered number.

11. The unit or set approved as the pattern instrument of a type shall be retained without alteration by the maker. The Postmaster-General shall have the right at any time to select any set of an approved type for test to see that the set is reasonably similar to the approved pattern. In the case of sets of an approved type employing reaction being found to oscillate the aerial, the Post Office may cancel the authorization  
(Continued on page 1706.)

# A Bulb Receiver Using Rectified Alternating Current

By FRANCIS J. ANDREWS

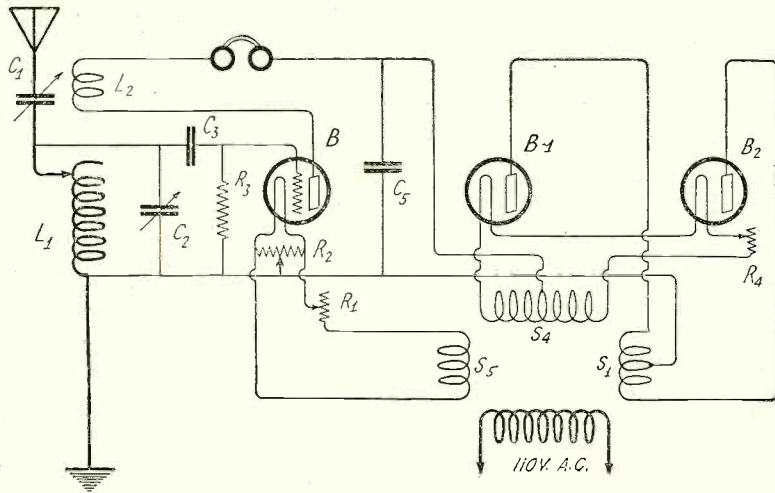

This Circuit Is Designed For the Full Wave Rectification of the Usual Alternating Current With Which Homes Are Supplied. The Usual "A" and "B" Batteries Are Unnecessary.

ing the diagram, the construction of this transformer will be readily understood.

- Following are the parts and material necessary for the construction of this set:
- 1 vario-coupler ..... 3.50
  - 2 variables, .002 mfd. .... 7.50
  - 1 grid condenser, .00025 mfd. .... 40
  - 1 grid leak and mounting ..... 1.50
  - 1 detector tube ..... 5.00
  - 1 tube receptacle ..... .75
  - 1 20-ohm rheostat ..... 1.00
  - 3 2-mfd condensers ..... 4.50
  - 1 rheostat, 4 ohms ..... .75
  - 2 rectifying tubes ..... 15.00
  - 2 tube receptacles ..... 1.50
  - 1 rheostat, 10 ohms ..... 1.50
  - 4 pounds No. 16 D.C.C. wire ..... 3.00
  - Magnet iron for core of transformer. 1.50
  - Taps, switches, etc. .... 5.00

TOTAL ..... \$52.40

**T**HIS circuit is designed for the full wave rectification of the usual alternating current with which homes are supplied.

The plate current for the detector tube is supplied by two 2-element rectifying tubes.

A step down transformer supplies the necessary voltages for these tubes and the filament of the detector tube.

The filament of the detector tube is shunted by a rheostat R-2 with a resistance of 20 ohms. By varying the slider, the characteristic hum of the alternating current will be reduced to a minimum.

The condenser C-5 is of rather large capacity; between two to six mfd. It is a good idea to have this condenser variable, that is, tapped.

L-1 and L-2 are the primary and secondary of the usual vario-coupler; L-2 is used as a tuning inductance with the variable condenser C-1. The secondary of the variocoupler, L-2, is used as a tickler coil

to provide regeneration. C-3 is a grid condenser of approximately .00025 mfd. capacity. C-2 is the second variable condenser to provide fine tuning of the coil L-1.

R-3 is a grid leak. The value of this leak varies with different tubes. A little experimenting is necessary to obtain the right values.

R-1 is a small rheostat for the control of the filament current of the detector tube. One with about four ohms resistance will be satisfactory. The rectifier bulbs, B-1 and B-2, are of the usual two-element type; Kenotrons are excellent for this circuit.

R-4 is a small rheostat to control the filament current of the rectifier tubes. Its resistance should be about 10 or 12 ohms.

Now for the transformer:  
The secondary supplies two voltages; 6 volts and 60 volts. There are two 6-volt secondaries, one for lighting the filament of the detector tube and the other for lighting the filaments of the rectifiers. By study-

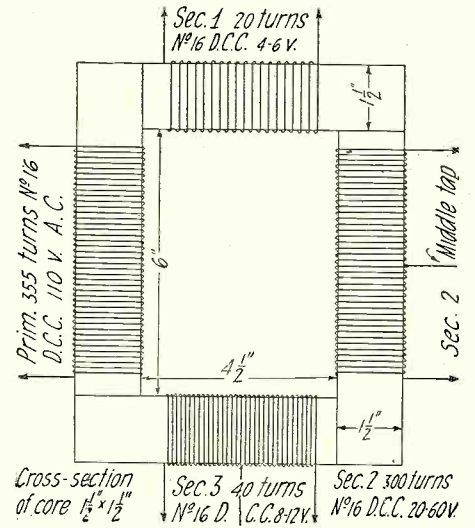

Specifications For the Windings of the Transformer Used With the Receiver.

## The New York Radio Show

**T**HE New York Radio Show held in the Grand Central Palace and organized by the New York Radio Exposition, admitted the radio public to its confines on December 21st. It is generally agreed that it was the most successful radio show that New York has ever seen.

Practically all of the large radio manufacturers were represented. The booths were unique as well as magnificent in their appearance and never failed to attract the eye of the passer. These booths were arranged in aisles in alphabetical order, an appreciated convenience to those who desired the location of some particular manufacturer.

From a summary of observations covering the displayed apparatus, it was evident that there is still a movement towards the standardization of one and two control receivers, using a single tube, and also the same type employing several stages of radio and audio frequency amplification and a small loop aerial. There were also a host of complete receivers, housed in cabinets designed along the same lines as those for phonographs, eliminating the usual scientific appearance and giving a more artistic touch to the whole.

Among the many novelties of the show were some of the giant models of apparatus displayed. These were exact replicas of the standard sizes and some actually worked.

One can imagine what a set could be installed using these monster instruments. A derrick and a windlass would probably be necessary for handling such an outfit.

Another interesting feature was the direct broadcasting of programs from the Grand Central Palace through station WEA-F. Upon the opening of the evening programs, the main lights in the Palace were dimmed and two large spot-lights were turned on and directed upon the balcony, where the main microphone was situated. Many celebrities appeared for the purpose of broadcasting. The show closed on the 30th of December. It is hoped that both the people and the manufacturers will profit by the exhibition of apparatus which was nearer to ideal design and workmanship than was evident a year ago. Among the exhibitors were:

- The Eiseman Magneto Company, Western Electric Company, Associated Manufacturers of Electrical Supplies, Coto Coil Company, National Airphone Corporation, C. Brandes, Incorporated, Dubilier Condenser Radio Company, Signal Electric Manufacturing Company, Jewett Manufacturing Company, Pathe Phonograph & Radio Company, Electric Storage Battery Company, Experimenter Publishing Company, Gould Storage Battery Company, Allen D. Cardwell Mfg. Corporation, DeForest Radio Tel. & Tel. Company, Radio Corporation of

- America, National Carbon Company, Marko Storage Battery Company, Weston Electrical Instrument Company, Pacent Electric Company, A. H. Grebe & Company, American Radio & Research Corporation, National Radio Products Company, H. Hyman Company, Formica Insulation Company, Hutchison Radio Co., S. Newman & Company, Crocker-Wheeler Company, Alden-Napier Company, Electric Specialty Company, Stanley & Patterson, Williard Storage Battery, Inter-Ocean Radio Corporation, Fiber Products Company, The Radio Guild, Miliken Bros. Mfg. Company, General Insulate Company, Davis Manufacturing Company, Triangle Phone Parts, Sleeper Radio Corporation, C. D. Tuska Company, Copper Clad Steel Company, Royal Electrical Laboratories, Musio Radio Company, Railroad Accessories Corporation, Harris Laboratory, Stromberg-Carlson Telephone Mfg. Company, The Bristol Company, American Bell Radio Company, Engravers & Printers Machinery Company, Rasla Sales Corporation, Malone-Lemmon Laboratories, Moon Radio Corporation, Novo Manufacturing Company, Feri Radio Company, Tait Knob & Dial Company, Bel-Canto Corporation, Ranco Electrical Products, Incorporated, Clapp-Eastham Company, Crosley Mfg. Company, Radio Mica Products Company, Holtzer Cabot Company, Betts & Betts Corporation

(Continued on page 1741)



The Radio Industry is undoubtedly Giving Birth to Better Advertising as Evidenced by Some of the Novel features at the New York Radio Show Held During the Latter Part of December. The Exhibit of Giant Replicas of Standard Apparatus seemed to be Universal Among the Manufacturers. In Every Detail, These Large Duplicates Played Their Part Well, Creating Unusual Interest in the Booths in Which They Placidly Rested. The Radio Public Could Better Determine for Themselves the Merits of Various Products by Inspecting These Big Brothers. It was possible to Study every Detail, as Though a Standard Instrument was Under the Critical Eye of a Magnifying Glass. Some of These Exhibits Are Pictured Above. Most of Them Appear to Be Two-Man Jobs as Far as Manipulation is Concerned. A complete Outfit Composed of These Instruments Would Not Leave Much Space in the Average Room. Imagine Attempting to Tune in a Station on Such a Set!

# The Future of Commercial Radio

By C. A. REBERGER

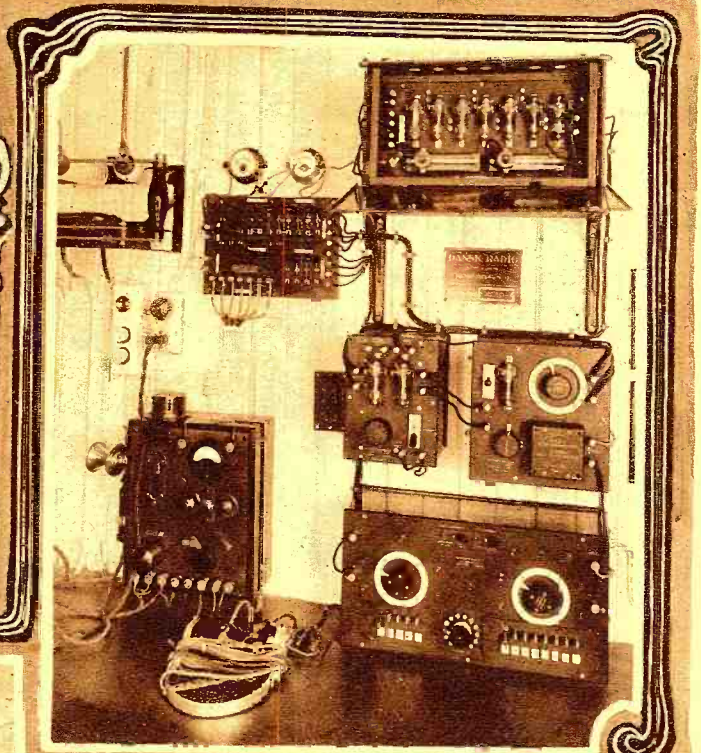
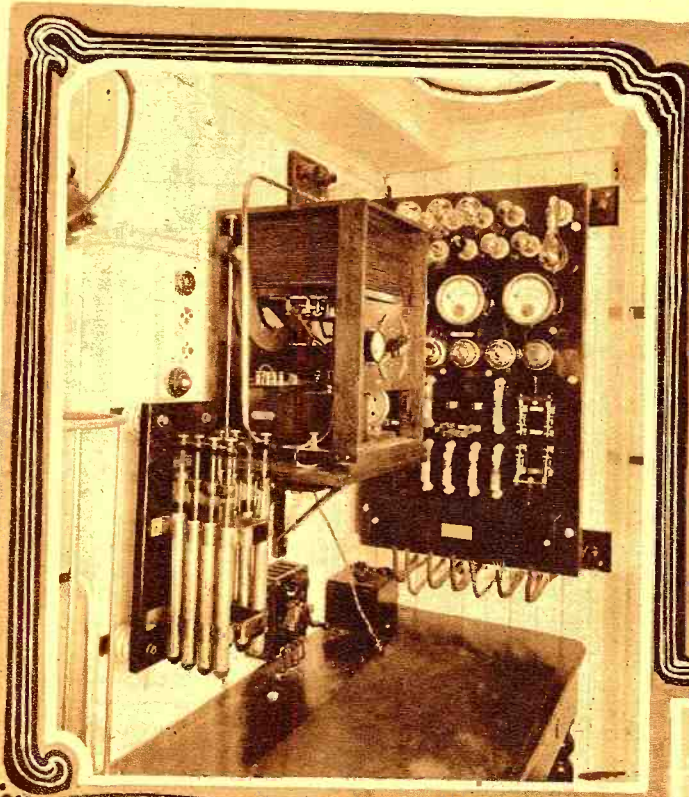

Above: The Main Transmitter Control Panel and the Auxiliary Transmitter Aboard the Steamship United States.

Above is Shown the Receiver With Amplifiers and Heterodyne and the Low Power Radiophone Transmitter.

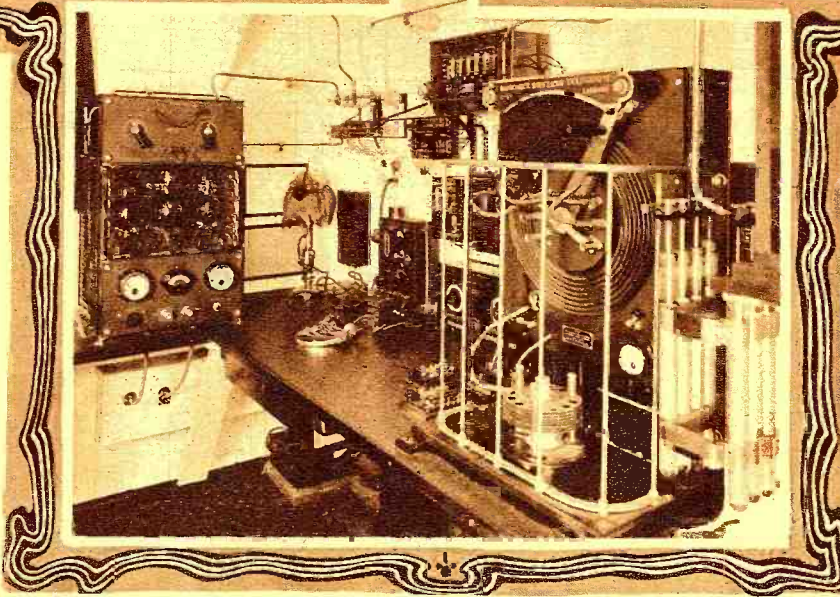

The 1 1/2-Kilowatt C. W. Transmitter is Seen at the Extreme Left. The Spark Transmitter is on the Right.

RECENT radiophone experimentations aboard the liners, *America* and *United States*, have startled almost the entire wireless fraternity, for they seem to place before us a huge mirror in which we can plainly see the future of commercial wireless—a new and wonderful change in radio, as a whole. "But what is the future?" we might unhesitatingly ask ourselves. From indications coming out of these tests, it is safe to make the assertion that the near future holds wonders for radio developments. It will not be something "great" nor out of the ordinary to sit in a soft, velvety chair in our home ashore and converse with a relative or friend aboard some vessel far out at sea. A very recent test conducted aboard the *United States* (OZD) by the two radio officers and Captain Volberg, conveys to us a vivid picture of future ship radio and the feasibility of adopting such methods for carrying on communication with ships. It marks the birth of a new era in ship to shore telephony.

While in the North Atlantic, chief operator Madsen decided to carry out some tests. Seated at the operating table in the radio room of the *United States*, he called the shore station TFA located in Iceland. Both stations were then far apart, but his

efforts were successful, for he was given an answer by the radio men at that station. They even went so far as to report that the voice from the ship was far clearer than the average house telephone. They conversed for some time and then it was decided to try another scheme. But operator Madsen did not have the chance to try his new plan for, upon going down to a lower wave-length on his receiver, he was surprised to hear a voice calling the *United States*. It was a company official at Copenhagen who wished to talk with Captain Volberg. He was then seated comfortably in his home. The Captain and company man talked for a short time, during which some very important orders were given. Later a correspondent from a Copenhagen newspaper called up the City Editor's office and gave him a batch of

very useful and valuable news items. Several passengers getting wind of the experiment, and seized with a sudden inclination to speak over the radiophone, hustled to the wireless room and soon were talking with friends at home; telling them of conditions at sea, when the vessel would arrive at her berth, etc. This was all made possible by the 1 1/2-kilowatt radiophone set at the Copenhagen shore station being connected up with all the telephone lines throughout the city. On this same night, a young woman passenger talked with her aged mother, whom she had not seen in many years. The mother was so thrilled by hearing her daughter's voice over the telephone, that she burst into tears, and asked if it were true or only a dream.

At another date, Captain Volberg talked with Captain Mecklenburg of the steamer *Frederick VIII*. At this time, which was in late Summer, the two ships were more than 470 miles apart. As the latter vessel possesses no radiophone outfit, Captain Mecklenburg was compelled to answer by the assistance of his ship's spark set.

The radiophone set was installed aboard the *United States* by the Danish concern which controls her radio equipment, for the

(Continued on page 1694)

# Radio Pictorial

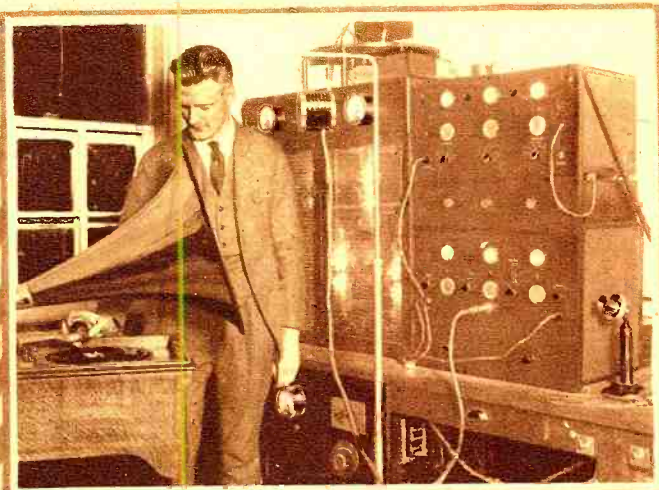

Rev. Francis Duffy O'Laughlin, S.J. Ph.D., Head of the Department of Physics at Fordham University, Long Ago Saw the Great Possibilities of Radio and It Is Due to His Efforts That Fordham University Now Possesses Such a Fine and Elaborate Equipment.  
(c) Kadel & Herbert

This Photo Shows Operator George H. Oliver Broadcasting a Phonograph Selection. The Sounds Picked up by the Microphone Are Carried to the "Modulator" (Shown on the Right). From There They Go into the Speech Amplifier (Shown on the Left) and thence to the Aerial.  
(c) Kadel & Herbert

Boy Scouts and Wolf Cubs on the Premises of Messrs. Auckland & Sons, Listening to the Message Recently Broadcast by the Prince of Wales.

## At A Radiophone Party

By RING W. LARDNER

I DON'T suppose by this time that there are more than a few families left in the world that haven't a little radio in their homes, though personally we are still without one as you halfto pay cash for same.

But my village has got its share of the machines, and I've been lucky enough to be invited to a couple homes where they had them, and will admit they are a great institution and libel to go a long ways toward keeping the men and boys in at nights though in a good many cases I would rather have them out if I was mother.

The places I have been to hear them, why they was connected with sending stations in Newark, Schenectady and Pittsburgh and if you didn't like the program that was going on in one place why you could change plugs and switch to another which sounds like a grand scheme but the trouble with it is that you pretty near always seem to go from bad to worse.

Well we started out one night with Schenectady and heard a voice say that the program would open with the baseball scores for the P. M. and he says St. Louis or somebody had beat New

York in the American league by a score of 6 to 4 and just as he said it the instrument let out a terrific blatt and I thought maybe it was the pitcher squawking to one of the umpires but our host said it was static.

Whatever it was we did not hear no more baseball scores but personally I didn't raise no howl about that as I figure that a person that has got any kind of self control can wait for the morning papers to tell how the games came out a specially in May.

Well the next number was a bed time story but it wasn't much more than 7 o'clock and while that may be bed time in Schenectady why most of we Great Neck folks don't hardly ever turn in till 8 and sometimes 1/2 past so we switched off of Schenectady and cut in on WJZ which is code for Newark.

Well a gal started to sing I love you truly and I made the remark that no wonder they was so many murders in New Jersey and another of the boys said he didn't think they had been quite enough.

The next piece was a cornet solo which was mostly what they call triple tongue

work and it would of drove me right to Pittsburgh if I had my say, but our host was a bug on cornet playing and set there beating time with his tongue till the last squawk.

When we finely got to Pittsburgh a man was just commencing a speech about a new expedition to the Pole but the next thing you know he was making a political speech about what a big mistake it would be to cut down the personal of our navy just at this time and here is his speech verbatim as near as I can remember same:

"With the Far Eastern question still unsettled in spite of the forward strides taken by the disarmament conference in Washington, now is surely not the time to reduce our static squawk blash ma-a-a-a."

"No country on the great green foot stool desires more earnestly than the U. S. but blah, biz-z-z-z-z, dot, dash, two dots, dash, ma-a-a-a-a."

The host informed me that these last few noises with a police station cutting it but I don't know if they got the fellow or not.

The closing number of the program  
(Continued on page 1714)

# Illustrated Radio News



A Crowd of Children and Grown-ups Gathered About a Grocery and Liquor Store at San Jose de las Lajas About 25 Miles from Havana, to Hear Their First Radio Concert Broadcast by Station PWX of the Cuban Telephone Company at Havana, Cuba.  
(c) Underwood & Underwood

Mr. Charles William Taussig, Noted Author and Radio Engineer, Holds Regular Dances for His Family and Friends in His Home in New York and Uses Radio Music Broadcast from Chicago for This Purpose. His Outfit Consists of Three Stages of Radio Frequency, Detector and Two Stages of Audio Frequency Amplification. By Means of a Loop Aerial in the Plate Circuit of the Detector Tube. He Feeds Back the Oscillations into the Radio Frequency Amplifier Through a Second Loop Aerial Which Increases Amplification Tremendously.  
(c) Kadel & Herbert

Work Has Been Completed on the First of the Two 100' 12-Ton Steel Towers Atop the Aeolian Building, New York City, to Hold the Antennae for the Country's Largest Broadcasting Station. By March 1, This New Station of the Radio Corporation of America Will Begin to Pick up and Broadcast the Many Important Local Concerts and Recitals by the World's Greatest Musicians. All of the Halls and Concert Chambers Have Been Especially Wired so That a Mere Turn of a Switch Will Suffice to Carry the Music from the Various Rooms in the Building. Because of the Great Weight of the Towers and Machine House, a Special Street Foundation for Them Was Constructed and Attached Directly to the Steel Frame Work on the Sides of the Building so That the Burden Does Not Fall on the Roof.  
(c) Underwood & Underwood

Dick Gordon (left), Son of the Camp Director, and Ralph Mahan Are Seen Receiving a Radio Message Through Their Portable Set at Camp Kanohwahae in Interstate Park. The Small Aerial They Use Is Conveniently Supported Atop Their Skis.  
(c) Underwood & Underwood

A Unique Broadcast Receiver is Shown Here Installed in an Automobile. Power Amplification Is Employed so That Sufficient Energy May Be Obtained to Attuate the Loud-Speaker Shown in the Rear.

Recently Transmitters Were Installed on Two of These Cars Which Could Keep in Touch With Each Other at a Distance of About 15 Miles During Experiments Carried Out Near Dayton, Ohio. The Radiophone Sets Were Operated from the Storage Battery of the Car and Proved Entirely Practical for Short Range Communication.

# Mr. Bimberry Hears the Banquet

By ELLIS PARKER BUTLER

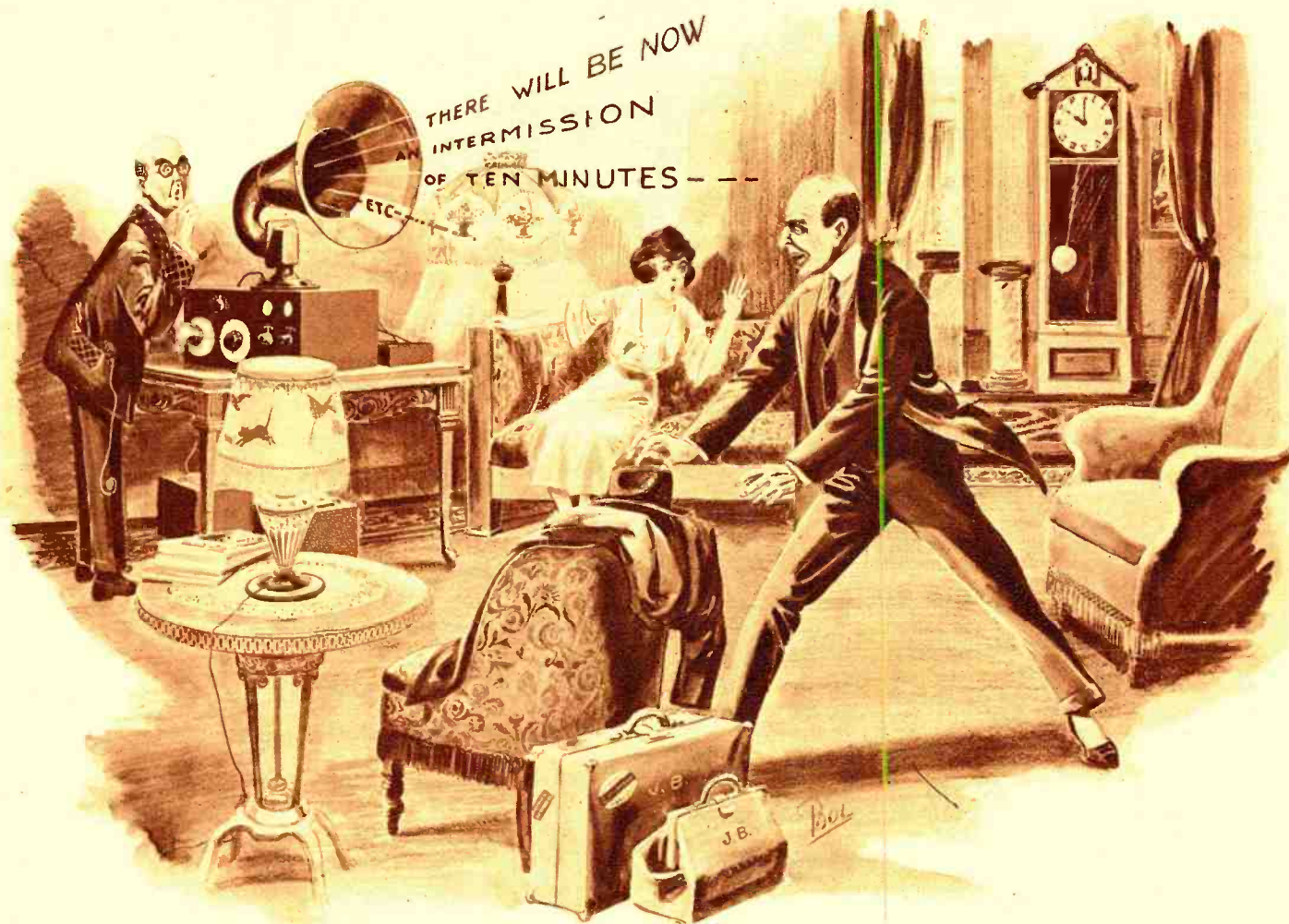

There Will Be an Intermission of Ten Minutes for the Retransmission of Arlington Time Signals and the Weather Reports for New York and New Jersey, After Which—But There was No "After Which" for Mr. Bimberry. He Gave One Glance at His Watch, Jumped for His Suitcase and Let the Door Slam Behind Him as He Leaped Down the Front Steps and Sprinted for His Train.

**F**OR quite a while after Mr. Bimberry's first radio experience at Mr. Murchison's house he refused to have anything more to do with radio as exemplified by Mr. Murchison's outfit, but one evening on the way home on the train, he happened to mention to Mr. Murchison that he was a great admirer of George Kade, the great humorist.

"I'd give eighty dollars to hear that fellow make a speech," Mr. Bimberry declared. "For fifteen years I have wanted to hear George Kade make a speech; it is the one great unfulfilled desire of my life."

At these words Mr. Murchison clapped his hand on Mr. Bimberry's knee.

"Bimberry," Mr. Murchison cried, "you can hear him! I must say, Bimberry, this is the luckiest thing that ever did happen! You can hear George Kade speak, and you can hear him make a speech that will be the finest speech he ever made in his life, and you can hear him this very night! Tonight, Bimberry, George Kade is going to be the principal speaker at the Monks' Club banquet at the Vastor Hotel, and you can hear him. At the Monks' Club banquets, Bimberry, the speakers always make the best speeches they ever make in their lives, and you can hear the great George Kade make that speech this very evening. Yes, sir! Look here!"

Mr. Murchison unfolded his newspaper and pointed to the radio programs on page

14. There it was in plain black and white: "Station WPX—360 meters, 8:30 p.m.—The speech of George Kade, the celebrated humorist, will be broadcasted direct from the Monks' Club Banquet, held in the Grand Ball Room of the Hotel Vastor, New York."

"Talk about luck!" exclaimed Mr. Murchison. "You happen to mention George Kade, and here he is being broadcasted this very evening. It is miraculous. But everything about radio is miraculous. I tell you, Bimberry, every day, in every way, I get crazier and crazier about radio. Now, I tell you what you do—you come over this evening about 8:15, and we'll get all settled nicely in our chairs, and all tuned in clean and clear, and you'll hear George Kade speak just as clearly as if you were right there in the Grand Ball Room of the Vastor."

"Well, I'll do it, Murchison," said Mr. Bimberry doubtfully. "I did say I would never fool with radio again, but I do want to hear George Kade once before I die. I'll come over at 8:15. But I've got to go at 10—you'll understand that, I've got to go to Chicago tonight, and I have to catch the 10:05 to town. So you won't mind if I bring my suitcase with me and get up and run at 10? You don't think it is rude?"

"No, no!" said Mr. Murchison. "That's all right; I understand, Bimberry. But be on time; I can't make the radio wait, you

know—when it comes it comes—it's not like a phonograph."

"I'll be on time," said Mr. Bimberry, and he was. When he entered Mr. Murchison's home Mr. Murchison was twiddling the dials of his set and Mrs. Murchison was seated before the big horn with her knitting in her hands.

"I'm not late? I haven't missed anything? Kade hasn't begun yet?" Mr. Bimberry asked anxiously.

"No; they have not begun yet," said Mr. Murchison.

"I'm glad of that," said Mr. Bimberry, and he turned to Mrs. Murchison: "I wouldn't miss this for a farm," he said to her; "I can't thank Murchison enough for giving me this chance. For years and years I've wanted to hear George Kade make a speech, and now—"

"Shush! They're beginning!" announced Mr. Murchison, and Mr. Bimberry settled into a chair, a smile of eager expectancy on his face. He unbuttoned three buttons of his vest in order to be able to laugh with full heartiness as the first comic words of George Kade came to him. He leaned forward and gripped the arms of his chair and unloosened—so to speak—the laughing muscles of his face.

"Shush!" whispered Mr. Murchison and held up his hand. From the horn came quite clearly a voice.

(Continued on page 1682)

# Borrowing An Aerial

By MOHAMMED ULYSSES SOCRATES "FIPS"-Head Office Boy

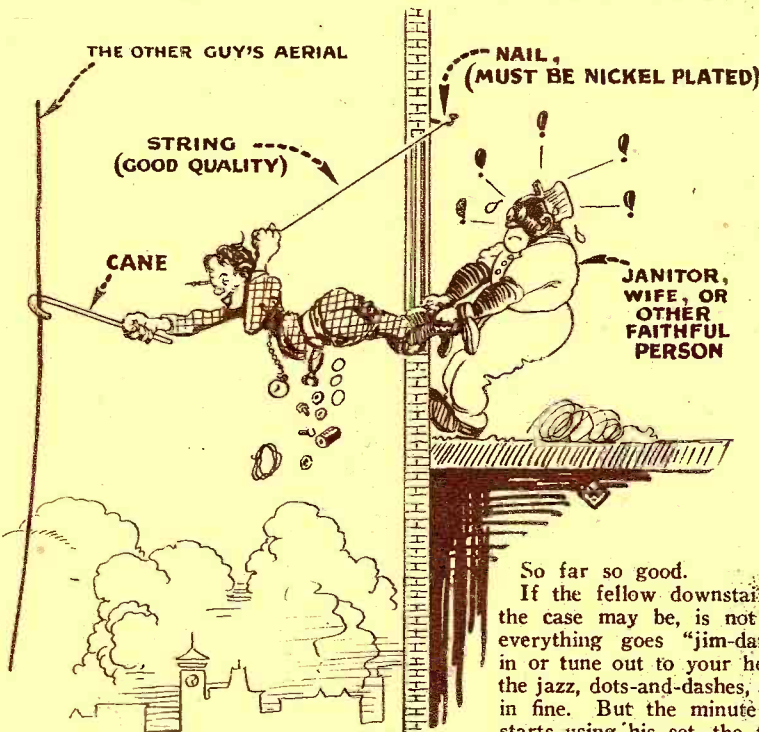

All You Have To Do Is Take a Cane, a Stick or Whatnot, and Fish for the Aerial That Obstructs, Quite Unlawfully Your View to Outside Nature and the Universe in General.

So far so good.

If the fellow downstairs, or upstairs, as the case may be, is not using the aerial, everything goes "jim-dandy." You tune in or tune out to your heart's content, and the jazz, dots-and-dashes, and whatnot, come in fine. But the minute the other fellow starts using his set, the fun begins! Now the game starts in earnest! If you wish to enjoy the game it is necessary, as said before, to close the window. If you do not, soon a lot of blue smoke will come floating either up or down, all depending upon where the owner of the aerial is located. The blue smoke comes from the profanity let loose by the other fellow because the minute he starts to tune in he will have the surprise of his young life. Also, you are informed immediately when his tuning starts, particularly if he has a vacuum tube set. Little squeals resembling those of a butchered young pig reach your innocent ears. This gives you due notice that the owner is tuning in.

While he is doing so, the signals in your

own set become weak too. You start tuning likewise.

AH!—the reception becomes distinctly better, but, right away, more squeals! The fellow downstairs can't get the hang of the whole thing, and must tune again. You and he keep tuning back and forth for some minutes, he downstairs much puzzled, you, yourself, much amused, because you know what the trouble is, whereas he doesn't! That is the fun of the game.

After tuning back and forth for about ten minutes or so, finally, between the two tunings a balance is struck, and then both can enjoy the concert, jazz, etc. But let either of the two fans touch the tuning knobs ever so little, and, immediately the balance is upset, and more laborious tuning must be done.

Imagine the feelings of the amateur downstairs! He can not account for the queer behavior of his set and thinks something has happened at the broadcasting station, then, two seconds afterward, he knows darn well that nothing has happened, and he can not account for the whole blamed business. He will start working on a new theory of Radio, all his own, and will have many sleepless nights. He will call in radio experts, who will be even more puzzled than he, poor bird, himself.

CAUTION!! Be sure never to let this tortured soul downstairs know that you borrowed the aerial. If you do, there is likely to be a funeral, and it won't be his, either!

A system not quite so dangerous to yourself is more simple. The other day, while locking from one of my back windows, I found that a new aerial had sprouted up during the day. As I have two windows in this particular room. I found that there was an aerial in front of each one.

A great light suddenly dawned upon me! Why not use the two aeriels, and no ground? No sooner thunk than done! Instead of "borrowing" one aerial, I borrowed both of them, running a lead through each separate win-

(Continued on page 1706)

**W**HO is the meanest man in Radio? The answer is simple: The one who "borrows" an aerial! "Borrowing" an aerial is the latest indoor sport, but it can, however, be practised only in cities that have apartment houses. The game can be played by any one, and is simple enough if conditions are right.

In cities such as, for instance, New York, Chicago, San Francisco, etc., the chances are 100 to 1 that every amateur who lives in one of the "cliff dwellings" can pull off the stunt. It is absurdly simple!

The idea is, in brief, to "borrow" someone's aerial, the same as you might borrow an umbrella. When you are through with the umbrella you return it—or perhaps you don't. Same with the aerial.

It works this way: Now that all our cities have most of their apartment house roofs garnished with 57 varieties of aeriels, which we silly boobs of amateurs put up, it is no longer necessary to put one up yourself. Open up your window and look out. The chances are that, if you are on an upper floor, one of the aeriels passes close by one of your windows. Simple, isn't it? All you have to do is to take a cane, or stick, or whatnot, and fish for the aerial that obstructs, quite unlawfully, your view to outside nature and the universe in general. After you have thus grabbed the aerial, anchor to it a lead-in of your own. It isn't necessary to solder your lead in. An ordinary clip such as you can buy in any hardware gent's furnishing store, or the like, is all that is necessary.

CAUTION!!! The game can be played safely only at night. If you attempt it during the daytime it becomes dangerous. You might have a couple of arms, or fingers shot off, once the owner of the aerial gets wise to your innocent pastime.

When you have anchored your lead in to the other fellow's aerial, close your window, run the lead to your set, the other wire going to your radiator or water pipe. Then proceed to tune in.

An Electro-Magnet Operates, and Two Lazy-Tongs Shoot Out Toward the Two Aeriels, Which Are Gripped Pronto.

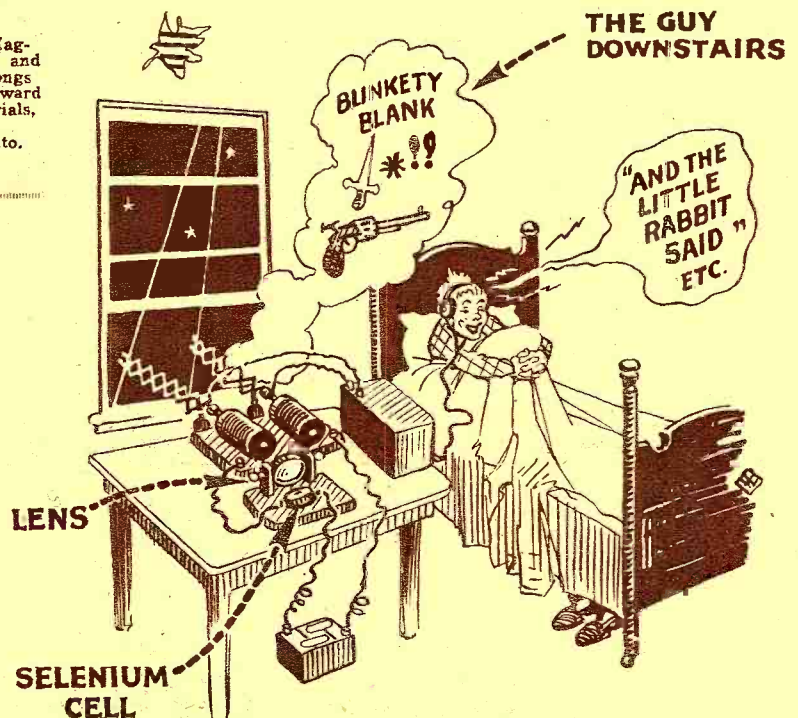



# Radio Pictorial

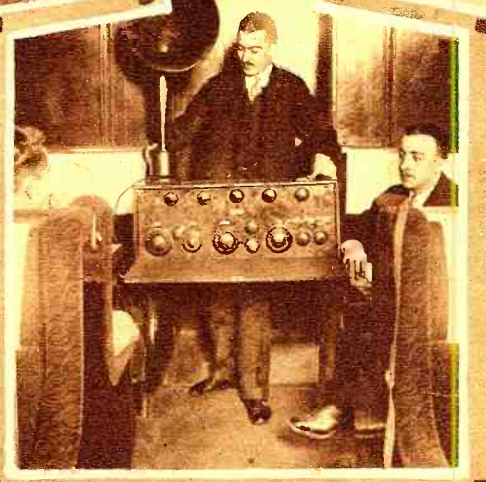
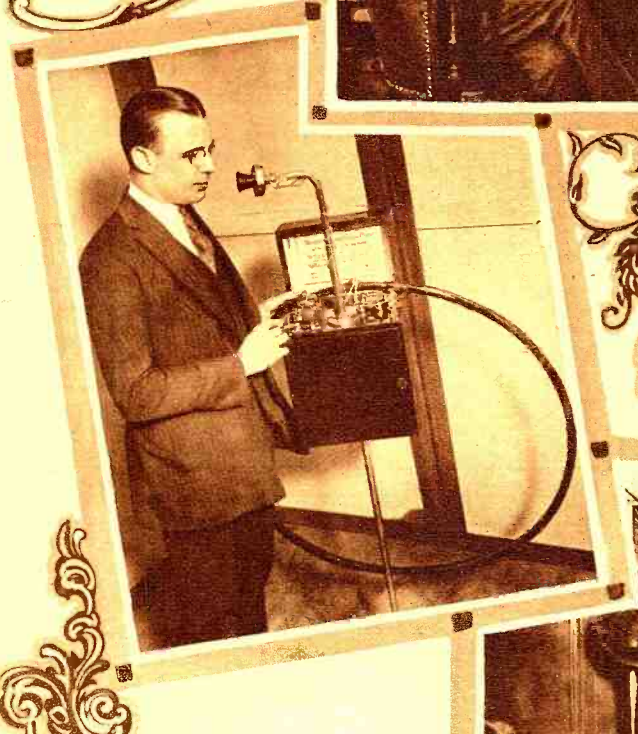
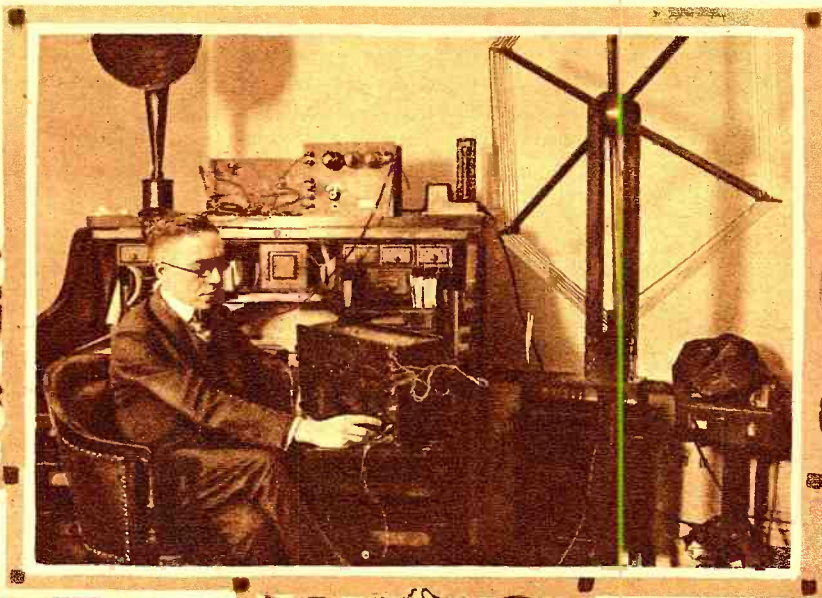

Top: Representative Vincent M. Brennan of Michigan Listening in at His Office to the Debates on the Floor of the House of Representatives Being Broadcast from the Naval Air Station at Arlington.

Right: The D. L. & W. R. R. Has Installed This Super-heterodyne Set as Part of the Radio Equipment on Board of the New York to Chicago Flyers. The Aerial Is Strung Along the Ceiling of the Car.  
(c) Kadel & Herbert

Center Photos: Dangers of Underground and Undersea Work That Has Caused the Loss of Hundreds of Lives. Will Be Greatly Minimized in the Future. Rescue Work Will Be Directed by This New Radiophone Which Talks Through Solid Stone Walls. This Apparatus Was Invented by Bernays Johnson and Requires no Aerial or Ground. Its Entire Motive Power Is Furnished by Small Dry Batteries Which in Turn Actuate Unique Transformers, These Generating the Magnetic Waves.  
(c) Kadel & Herbert

## Tunes, Sounds and Slogans Are Becoming Popular

**B**ROADCASTING stations are coming to be known by the voices of their announcers, their slogans and the stunts they do to identify their stations as well as the cryptic call letters assigned by the Department of Commerce.

There is little romance or euphony in the letters "WSB," but listeners-in are very familiar with the big gong which rings "bong, bong, bong" with the an-

nouncement of the entertainment and know it is the *Atlanta Journal*. The unmistakable southern drawl of the broadcaster there announcing that this is the "Voice of the South" is also an indication that WSB is sending.

As the radio enthusiasts well know, there are a number of other stations using identifying phrases and sounds. For example, *Courier Journal* and Louis-

ville *Times* WHAS, play a few bars from the appropriate Southern melody. "My Old Kentucky Home." WDAJ, the Atlanta and West Point R. R. Co's Station, at College Park, Georgia, has conceived the unique method of establishing its identity and business by blowing four blasts on a locomotive whistle; when "toot-toot-toot-toot" resounds in your  
(Continued on page 1724)



## A Selective Multi-Range Regenerative Receiver

By KENNETH HARKNESS

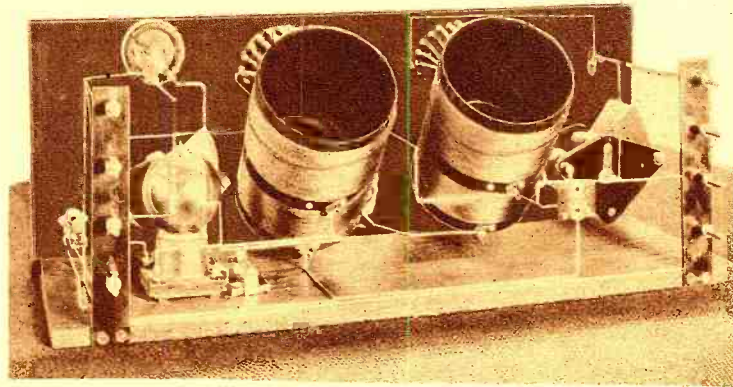

Rear View of the Complete Receiver. Two Multi-Range Couplers Are Employed in Conjunction with the Necessary Condensers. Note the Neat Appearance Effected by the Bus Bar Wiring.

**A** VERITABLE avalanche of requests for further information concerning the "Multi-Range Regenerative Receiver" described in the November issue of RADIO NEWS has inspired the writing of this article. The writer endeavored to reply individually to the questions of these correspondents but to the many who asked for a full and detailed description of how to construct a loose-coupled receiver performing the same functions as the direct-coupled receiver the present article is addressed. It will probably possess interest also to others who wish to construct a regenerative receiver covering the useful bands of wave-lengths from 170 to 3400 meters.

We are well aware of the advantages of a loose-coupled receiver. In the discussion of the respective merits and demerits of direct-coupled and loose-coupled tuners the radio amateurs are divided into two camps. There are those who swear by the former and the others who laud the superiority of the latter.

There is something to be said for each side. The chief argument in support of the single-circuit tuner is its simplicity of tuning. There is a smaller number of controls which greatly simplifies the operation. It is easier to pick up signals and tune them in to maximum sensitivity.

While the loose-coupled tuner has more controls and is therefore more complicated to tune, the great argument in its favor is the resulting selectivity. It is also claimed that the loose-coupled receiver is less affected by static and atmospheric strays. The reason for these advantages of the loose-coupled tuner is easily understood.

Both the antenna circuit and the secondary circuit are tuned to the incoming signal. Regeneration greatly increases the energy in the secondary circuit and the coupling between the primary and secondary circuits must be made very small to maintain resonance. Therefore, while forced oscillations may be set up in the antenna circuit by passing radio waves of different frequencies, these do not affect the secondary circuit which is tuned to the desired frequency and very loosely coupled to the antenna circuit.

The receiver illustrated in the photographs possesses all the advantages of the standard loose-coupled regenerative receiver with the additional advantage that it is operative over a wave-length range from 170 to 3400 meters. While this feature might result in a loss of efficiency on the short wave-lengths in a receiver of improper design, the manner in which the inductances are wound prevents this loss. To construct this loose-coupled receiver two multi-range couplers are required. For the convenience of those who did not read our previous article on the subject we will briefly give the specifications of this type of coupler which greatly simplifies the construction of a short and long wave set and maintains efficiency on all wave-lengths.

The main inductance is wound in two sections on a bakelite tube 4" in diameter and 6" long. One section is wound single layer for the reception of short waves. The other section is spaced  $\frac{1}{2}$ " from the short wave portion and consists of a three layer bank wound inductance. It is this method of winding and the spacing between the two sections which prevents loss of efficiency on short waves.

The short wave section is wound with 60 turns tapped every tenth turn and the long wave section is wound with 210 turns tapped every 30th turn. The rotor is wound on a bakelite tube 3" in diameter and 2" long

with 46 turns of wire. The rotor revolves inside the short wave portion of the main inductance and the shaft is set at an angle to permit a 180-degree variation of coupling. All windings are made with No. 22 double silk-covered wire.

In the direct-coupled tuner the rotor is used as the "tickler" coil to produce regeneration but in the loose-coupled tuner two couplers are required and the rotor of the first is used to couple the two circuits while the rotor of the second is the "tickler" to produce regeneration.

If reference is made to the back view of the completed receiver and to the wiring diagram the method of operation will be clear. The antenna circuit consists of the short and long wave portions of the first coupler with a .001 M.F. variable condenser in series for close tuning. Coarse tuning of the antenna circuit is obtained by short-circuiting portions of the tapped inductance by means of the switch.

The secondary circuit consists of the short and long wave portions of the second coil in series with the rotor of the first coil. Coupling between the two circuits is obtained with this rotor and the coupling can be maintained at a very low value. Very fine adjustment of the coupling can also be obtained by means of the 180-degree variation. Coarse tuning of the secondary circuit is obtained by short-circuiting portions of the tapped inductance with the second switch and fine tuning by means of a .0005 M.F. variable condenser shunted across the circuit. Regeneration is obtained with the rotor of the second coupler connected in series with the plate circuit of the system.

A loose-coupled multi-range regenerative receiver is somewhat more expensive to construct than the direct-coupled type as it requires more parts but it is our opinion that the resulting selectivity in tuning is worth the additional cost.

The parts required for the construction of this receiver are as follows:

- 1 Bakelite panel, 21 $\frac{1}{2}$ " x 8" x 3/16"
- 1 Wooden base, 21" x 7 $\frac{1}{2}$ " x 1/8"
- 2 Bakelite terminal strips, 7" x 1" x 1/8"

Front View of the Receiver Showing the Neat Arrangement of Controls. All binding Posts Are in the Rear Thereby Eliminating Unpleasantly and Bothering Connections in Front.

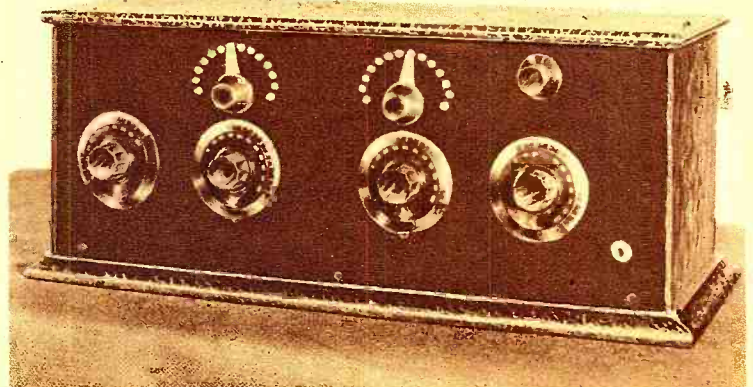

- 2 Multi-Range Couplers.
- 2 Switch sets (including 2 switch levers, 24 switch points and 4 switch stops).
- 1 Variable condenser (.001 M.F.)
- 1 Variable condenser (.0005 M.F.)
- 1 Filament Rheostat.
- 1 Vacuum tube socket.
- 1 grid condenser (.0005 M.F.)
- 1 grid leak (2 megohms).
- 1 Phone condenser (.002 M.F.)
- 1 Double-circuit phone jack.
- 8 Binding-posts.
- 4 Dials.
- 1 Cabinet.

**ASSEMBLING THE RECEIVER**

The photograph of the back of the receiver and the plan of the front panel clearly show the method of constructing this set with the foregoing parts.

In the plan of the front panel we have indicated only the center holes of the apparatus as the positions of the mounting screws vary in different types of apparatus.

The front panel can easily be drilled by the constructor himself with a hand-drill and finished with sand-paper and oil. The two multi-range couplers should then be screwed in the positions indicated in the photographs and the wiring between the taps on the couplers and the switch points completed. This should be done with flex-

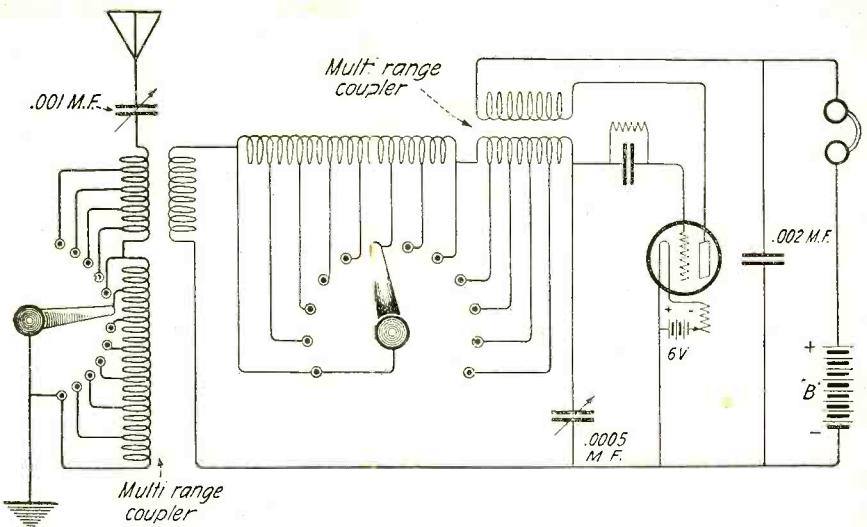

Circuit Diagram of the Described Set. By the Use of Two Couplers Flexibility of Control Is Accomplished, While Regeneration Is Obtained by the Usual Tickler Method.

circuiting wire from the center of the switch lever to the last switch point should be of litz to permit the switch to revolve.

With the wiring from the couplers to the switch points completed, the two variable condensers, the rheostat and the phone jack

$\frac{1}{2}$ " long, which is tightened down with a nickel-plated 8-32 tapped spacer. The screws project through holes in the back of the cabinet and the binding-post tops are screwed down on wires connecting to the batteries.

**NOTES ON WIRING**

With the apparatus all assembled the wiring is completed as shown in the diagram. Referring to the back view photograph, the four terminals at the right-hand side are connected, from top to bottom, to the aerial, ground, negative and positive of the plate battery respectively. The four terminals at the left, from top to bottom, are for the output (two terminals) the negative and positive of the filament battery respectively. The two output terminals are connected to the center-points of the double-circuit jack. By connecting the terminals in this manner an audio-frequency amplifier can easily be added to the receiver as the four terminals are in the proper position for connecting to it.

In wiring to the rotors of the couplers it is necessary to connect the wires in the proper direction as, with the 180-degree type of coupler, revolving the rotor does not reverse the direction of current through the rotor. If the plate current does not pass through the rotor of the second coupler in the proper direction, it will be impossible to obtain oscillation. If there is any uncer-

*(Continued on page 1710)*

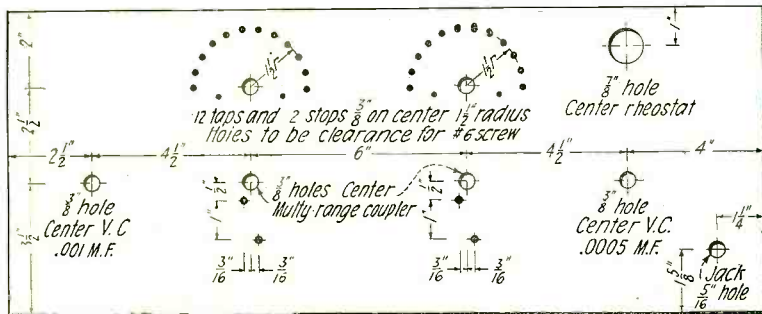

Layout and Measurements for the Drilling of the Panel.

ible wire covered with tubing. The wiring to the switch points should be made so that when each switch lever is on the first stop both inductances are completely short-circuited. In this manner, as the switch levers are turned to the right the value of inductance in the circuit and correspondingly the wave-length increases. The first few stops of the inductance switches will therefore control the shorter wave-lengths and these points should be wired to the short-wave portions of the inductances. The short-

should be secured to the front panel as shown and the front panel screwed to the wooden base. The tube socket and grid condenser should then be screwed to the base as indicated.

The binding post strips are each drilled for four binding-posts equally spaced and two counter-sunk holes are drilled at the end for screwing them to the base. The terminals are made up of stock parts. The screw is an 8-32 measuring  $1\frac{1}{8}$ " in length. Over each screw is slipped a fibre spacer

## Pointers In Operating Vacuum Tubes

By M. WOLF

**T**HE importance of properly taking care of the vacuum tubes in a set is so great that it is surprising so little is said on the subject. Tubes cost much and they burn out easily for one reason or another. The tube is the weakest element of the set. The average incandescent lamp in a house lasts much longer than the average tube. Since they are both burned to give a maximum life the vacuum tube should last as long as the incandescent lamp. Actually it does not. What is the secret?

The operator of a set tries to take as good care of the tube as he possibly can, but the trouble is he does not seem to be aware of what is actually happening to the tungsten wire of the filament. He knows that too much juice will decrease the life of his tube. Hence he tries to keep his filament current as low as good operation of his set will permit. Not only that, but when he quits operating his set he throws in all of the resistance in his filament rheostats so that when he starts his set

working the next time he must gradually cut out his resistance, thus making the filament current go through low values gradually, before reaching the operating value. The reason he does this instead of leaving his rheostats in the operating position is this: He figures if he leaves his rheostat in its operating position there will be a rush of current into the filament due to the storage battery having recovered some of its lost voltage, thus endangering his tube.

The trouble with this point of view is that it is incomplete and inaccurate and based on an insufficient knowledge of the properties of tungsten filament wire. It is true that storage batteries recover some of the lost voltage, but this recovery is relatively very small and not enough to endanger the life of the tube. The only time this danger is likely to occur is just after charging the storage battery. At this time the above precautions should be carefully observed. Of course occasional adjustments of the rheostat are always necessary, but apart from this there should be

no fear of the battery recovering sufficiently to burn out the tube.

Otherwise it is most beneficial and advantageous to the life of the vacuum tube to keep the filament rheostat at its operating point all the time and to flash the bulb instantaneously at its operating temperature when throwing the set into commission. This principle has been verified by the latest researches on the subject and the basis for this will be clear from the following data.

Microscopic examination of tungsten wire generally used in lamps and vacuum tubes shows that it may appear in two forms: (1) the ductile form, in which the wire appears to be made up of a continuous mass of small grains firmly welded together; (2) the brittle form in which the wire appears to be made up of fairly large blocks with definite boundary or cleavage lines. The ductile form of the wire may be bent without harming it, but if the brittle form is bent the wire immediately and easily

*(Continued on page 1711)*

# The Construction of A Loop Aerial

By D. R. CLEMONS

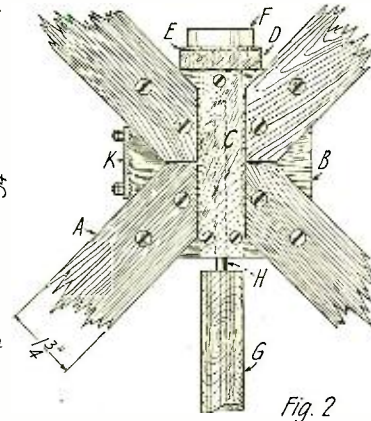
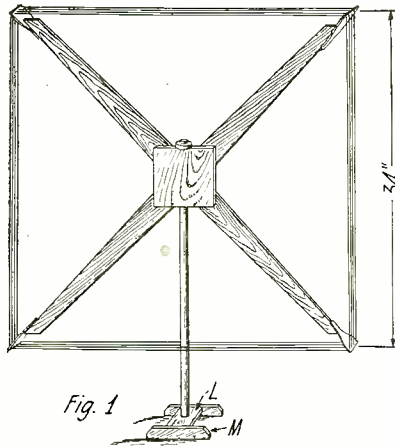

Constructional Details of the Loop Frame Work.

**I**N the experimenter's station a loop antenna may be employed for receiving, or for the "spotting" of transmitters when used as a radio compass. The energy received in the average loop is very small, so that a very sensitive detecting and amplifying arrangement should be used if long distances are to be covered. However, a loop could be used for receiving local broadcasting stations upon a single tube if the distance is not too great. Telegraphic signals may be received over much greater distances, and in this connection it is very interesting to experiment with them.

The design of the loop is more dependent upon the remainder of the circuit and the probable location of the loop during reception. For indoor use it must be reasonably small so that it may be placed upon a table or supported from the ceiling. If it is to be used as a radio compass of reasonable accuracy, its inductance must not be so large, nor the condenser used with it so small that any additional capacity to other bodies will detune it when it is swung about. By allowing a reasonably large condenser—not dependent on the leads and tube capacity alone—it "points" better. It is also possible to feed-back into the loop circuit for regeneration by coupling a tickler coil L3 to a very small coil L2, thus making the signals stronger and more sensitive. The introduction of coils L2 and L3 may cause the loop to be less accurate, but this may be corrected by using two small condensers in place of C1, the coil L2 being inserted between them as shown in Fig. 4A. In either case the over-all dimensions of the coils must be as small as possible.

The simple loop shown in the sketches is very easily made; and its cost is negligible. It is also very light, weighing only 3½ pounds. As many experimenters might like to build it, simple data will be given.

Since this loop was designed for normal reception on 600 meter stations, the inductance was made 700 microhenries so the capacity for this tune will be somewhat less than 150 micro-mfds., which is obtainable in the small 11-plate condensers on the market. In fact that type is desirable for this work in order that the tune may occur in the central portion of the scale, being less critical to adjustment than would be the case if the condenser were of the larger types. A condenser of 500 micro-mfds. could be used. Since this inductance is too great for use on 360 and 400 meters (the fundamental of the loop is 314 meters) a smaller value of inductance must be obtained. Suppose that reception on 400 meters is desired using the same capacity at C1 as before: the governing factor is the capacity and inductance of the system, their product being known as the LC constant.

Since  $\lambda = 1884 \sqrt{L \times C}$  where C is known L may be found by  $L = \frac{\lambda^2}{(1884)^2 C}$ ; or since the LC constant for 400 meters is 0.0450,  $L = \frac{0.045}{C \cdot 00015}$ , which is 300 microhenries. Then from the curve in Fig. 5, 300 micro-microhenries are found to be 12

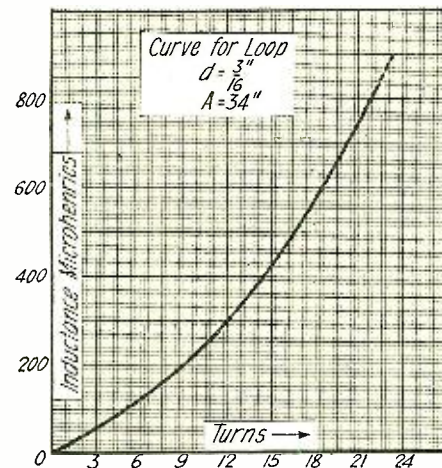

A Curve Showing the Inductance of the Loop for Different Numbers of Turns.

turns, but 10 turns would be advisable since the leads tend to add to this. So the loop may be made with 10 turns for 400 meters only; or of 20 turns for 600 and 360 meter work by placing a copper tab on the 10 turns.

The frame is built as follows: four light soft wood strips are cut 3/8" thick and 24" long, tapering from 1 3/4" at the base to a

width of 1" at the outer end. These are then attached by screws to a square section 3/4" by 5" square as shown at B in Fig. 2. A block 1"x1"x5" is mounted at C in Fig. 2, a 1/4" hole being accurately drilled along its length as shown by the dotted lines. A small bakelite strip K carries the terminals of the loop. The square block D is mounted as shown; E a square of thick felt, the two serving as a small table supporting the floating-dial magnetic compass at F. This compass is graduated into 1 to 359 points. The loop frame is supported upon a round wooden rod G, 20" long x 1" diameter. A length of 1/4" brass rod is driven into the rod G, the projection H fitting into the hole of the block C, forming a pivot for rotating the frame. A light base is made of two strips M in Fig. 1, with a block 5" by 10" at L. The rod G fits tightly into a hole in L. Twenty turns of No. 22 cotton covered wire are strung through bakelite strips shown in Fig. 3. These strips are cut from 3/32" bakelite shaped as shown. Twenty holes are drilled 3/16" apart, a space of 1/4" being blank at the center to divide the winding for passing the rod G. The wood may then be covered with shellac and varnished.

The loop is 34" on a side; weight 3½ pounds; inductance 700 microhenries having a fundamental of 280 meters. A tap for 300 microhenries is soldered to 10 turns for work on 360 meters. C1 may be a small variable condenser of 200 micro-microfarads maximum capacity; L2 is a small inductance of 30 microhenries (about 12 turns 3" diameter); L3 is a tickler coil of 800 microhenries (about 80 turns 3" diameter) for 360 meter work. L3 should be of about 1,000 microhenries for use on 600 meters (about 110 turns 3" diameter). C2 is a small fixed condenser of about 0.001 mfd.

If the loop is to be used as a radio compass, the hook-up in Fig. 4A is useful. C3 and C4 are each small variable condensers of 0.0005 mfd. with the other values the same as before.

Employing this loop with a single tube, ship and land stations 1,000 miles distant are located and read clearly. Broadcasting stations may also be located with the loop.

## AN AERIAL CLEANER.

If a fish line is tied to the center of an aerial, lots of trouble can be prevented this winter through breakage from sleet and snow, as a little jerk on the line will clear the aerial. It can be insulated with a cleat, where it is fastened to the aerial and the lower end tied out of reach, when not needed.

I used this method last winter and it saved my aerial quite a few times.

Contributed by E. C. GALBREATH.

Fig. 3.—End Portion of the Loop Frame for Supporting the Wire.  
Fig. 4.—A Desirable Circuit for Use With the Described Loop.  
Fig. 4A.—Insertion of Condenser C-3 and C-4 Will Increase the Accuracy of the Loop.

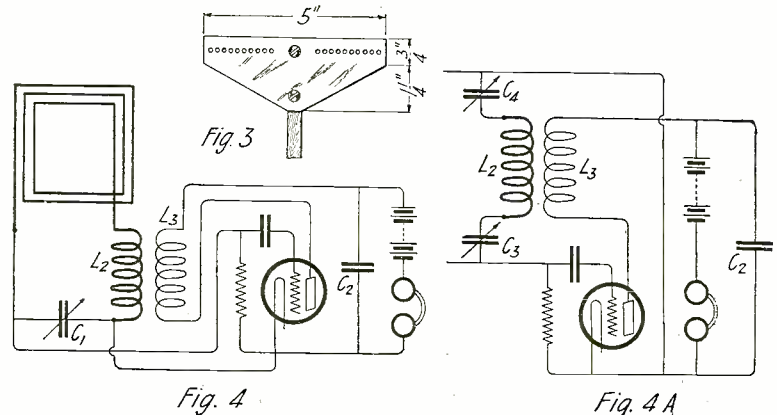

# The Principles and Construction of an Electrolytic Rectifier

By KENNETH M. SWEZEY

**I**N most localities, except in the immediate vicinity of power stations, alternating current is supplied to the homes that are equipped for electricity. The reason for this is because of the greater ease and economy of transporting alternating current over direct current. Power can be transferred over the long stretches at a high potential and low current strength, and then reduced by means of transformers to the correct voltage

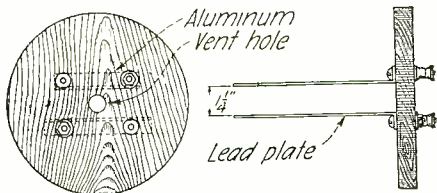

Fig. 2

The Lead and Aluminum Plates Are Attached Directly to the Wooden Jar Cover.

for district and individual use. You can readily see that this procedure allows the use of a smaller gauge wire, thus lowering the expense of the distributing system.

Alternating current is far from being a disadvantage to the work of the experimenter. It can be used the same as direct current for lighting lamps, and can also be used for running motors. If you possess alternating current you can rig up a "spark" radio transmitter, capable of covering great distances, at a small outlay. You can also, by its use, investigate the fascinating realm of high frequency currents, and perform all the spectacular stunts that are usually left to the laboratory, or to the wizard of the stage.

However, alternating current (or more simply, A. C.), cannot be used in places where a steady uni-directional current is required, such as for charging storage batteries, or for electro-plating. But still we have a method of overcoming this difficulty by means of what we call a rectifier. This piece of apparatus so changes the current that it becomes in effect a pulsating direct current.

There are five types of rectifiers in common use: the commutator, the magnetic vibrator, the mercury arc, the vacuum tube, and the electrolytic. For small storage battery charging purposes the magnetic vibrator, the electrolytic and the vacuum tube type are the most convenient. Of them all, the electrolytic is the easiest and simplest to construct at home. For those who can af-

ford to buy them, the other two types are to be recommended, as they are efficient, compact and little bother. However, for those who care to make a rectifier of the electrolytic type, the following principles of operation, and the details of construction of a de luxe model, are given.

Let us bring to our minds the experiment that illustrates the electrolytic decomposition of water. There are two electrodes used; one at which the current enters the solution, called the anode, and the other at which the current leaves, or the cathode. When a cell or a battery is connected to the proper terminals, the water is found to split into its component parts—hydrogen and oxygen. Hydrogen is given off from the cathode, and oxygen from the anode. As water is composed of two parts hydrogen to one part oxygen, its decomposition can be used as a positive indication of polarity. This is particularly useful to know when working with storage batteries. If the ends of the two leads that come from a storage, or any other kind of a battery, are immersed in a receptacle of water that has been slightly salted

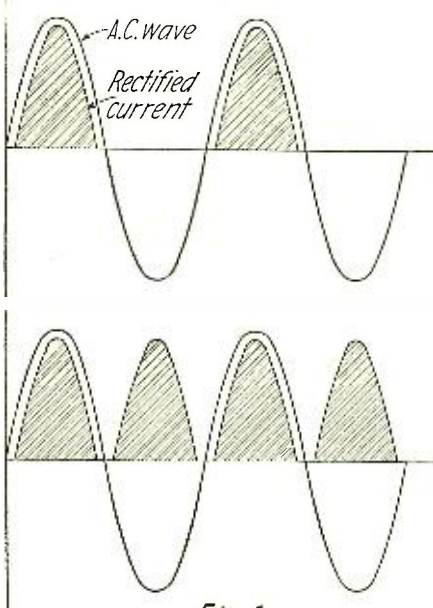

Fig. 1

The Top Sine Curve Shows the Direct Current in Relation to the Alternating Current Where Half-Wave Rectification is Employed. The Lower Curve Shows Full Wave Rectification.

or acidulated (this to lower the resistance), the lead from which the most gas, or the greatest number of bubbles, is given off, is the negative.

Now aluminum has the outstanding property of readily combining with oxygen, forming oxide of aluminum. Almost instantly a piece is cut, it is coated with a thin coating of oxide. However, this is so very thin that it is practically transparent to the human eye. But its presence is unmistakably proved when soldering or welding is attempted, as it renders these operations next to impossible.

Advantage is taken of this property of aluminum, in the electrolytic, or Nodon, rectifier. One electrode or plate is made of this metal, and the other of some chemically inactive substance such as platinum, carbon, iron, or lead. Lead has some advantages over the others mentioned, and is therefore generally used. These electrodes are immersed in a solution of aluminum phosphate in water.

If a potential is applied to this electrolytic cell in such a way that the lead plate is made the anode, a current will flow readily from the lead to the aluminum, hindered only by the resistance of the electrolytic. But if a potential is applied with a reverse polarity, so that the aluminum is the anode, the oxygen will so affect this metal that a tough skin of oxide will be formed that completely covers the plate. This oxide is a non-conductor, and hence the current is shut off.

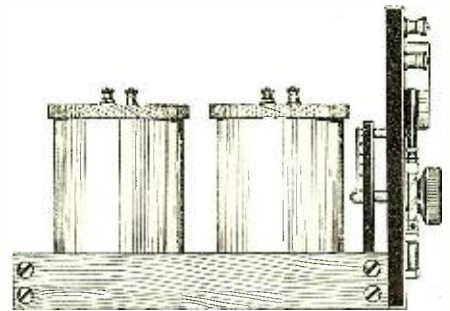

Fig. 4

Side View of the Complete Rectifying Outfit.

When placed in an A. C. circuit the effect of such a cell can readily be imagined. During one-half of an alternation the current would be allowed to flow, but during the other half the current would almost completely be shut off. The resultant current flowing through the circuit would be intermittent, and in single direction—in the direction of lead to aluminum. The direct current in relation to the alternating current is shown by Fig. 1. It is to be observed that only one-half of the alternating current cycle is made use of, and that the direct current is intermittent. By using a number of cells with the proper connections, both halves of the alternations can be made use of, and a current having an outline similar to that represented by the second curve in the same figure can be obtained.

Passing from theory, let us look at the practical side of the question. The amount of current that a rectifier will pass is limited, on account of the heating of the liquid. Five amperes is the maximum that can be passed continuously through one of the size to be described. Another disadvantage is the waste of power due to the high voltage of the supply and the necessary series resistance. Regardless of these faults, how-

(Continued on page 1678)

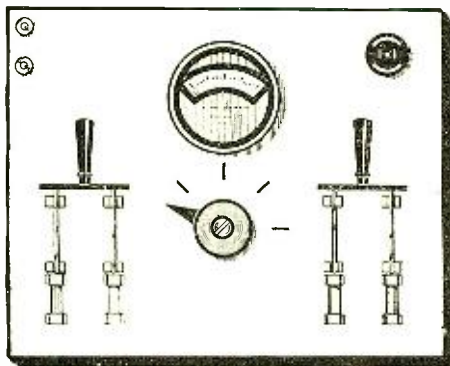
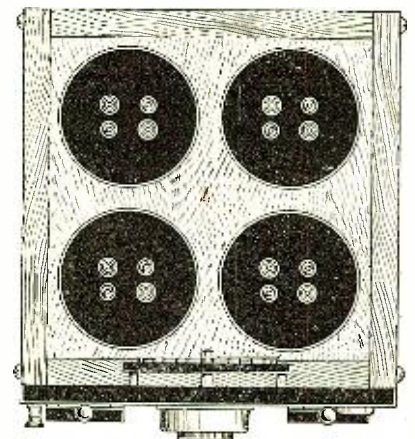

Fig. 3

General Layout of the Charging Cabinet.



Top View of the Rectifier and Control Cabinet.

# The Meter Bridge: Its Construction and Use

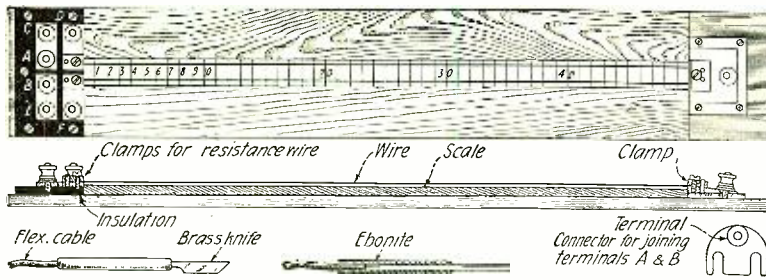

Fig. 1.—General Arrangement and Details of the Meter Bridge.

EVERY electrical worker at times necessarily makes measurements of resistance and capacity, and as wireless workers perforce possess a sensitive telephone receiver, the writer proposes to show how this in conjunction with a simple piece of apparatus combined with one or two simple standards can be applied to a number of purposes.

When a telephone is used in place of a galvanometer it must always be so arranged that it gives a "zero reading," i. e.,

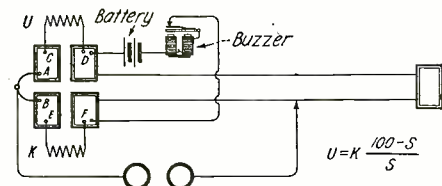

Fig. 2.—Connections for Comparing Resistances.

that the sound is reduced to a minimum, and to find the minimum it is sometimes advisable to make two readings when the signals become audible and then split the difference.

To use a telephone to give a scale reading could possibly be contrived by means of a Hughes induction balance, but as practically every measurement can be made by zero methods it is not necessary to add this complication. A serviceable meter bridge can be constructed by fixing two pins at any convenient distance apart and dividing the intervening space into 100 equal divisions, and then making the various connections with heavy cable so that, except for the resistance of the wire stretched between the pins, the resistance of the circuit is negligible.

For the sake of convenience this can be modified by making the resistance wire in a loop, as seen in Fig. 1, which gives a general idea of an improved form of this piece of apparatus, and has the following advantages over the old type of single-wire bridge: First, the length of the connections is reduced to a minimum, and, secondly, the size of the instrument is practically reduced by one-half.

Although any length of resistance wire can be used, one meter is a convenient length and about 24 S. W. G. bare Constantin is the best to use, but for very low resistances a thicker, and for very high resistances a thinner resistance wire is advisable.

The insulation of the various parts is very important and the scale should also be of non-conducting material. The writer has found that for the scale a piece of well-seasoned mahogany, with a strip of drawing paper glued on both sides answers well, if after being divided and figured on one side in india ink it be well coated with "dope" (celluloid dissolved in acetone) and then varnished with copal varnish. The object of treating both sides in a similar manner is to prevent the contraction of the paper distorting the scale.

The blocks with the terminals AC, BE can be made in one piece if desired, but the writer has found it convenient to have it divided in two parts for certain measurements, and it is a simple matter to connect the terminals A and B with the bridge piece shown at the bottom of Fig. 1. Similarly, it is sometimes useful to have a terminal on the block at the other end, although this is seldom used.

Of course, a galvanometer can be used in place of the telephone receiver, but a galvanometer comparably sensitive with a telephone is an expensive instrument and not sufficiently robust for use in a workshop.

A brass or copper bladed knife on the end of a flexible wire is a convenience in making the sliding contact (this is also shown at the bottom of Fig. 1), but the bared end of a piece of flexible wire will serve. It requires a little practice to find the zero point on the scale, as owing to the capacity and the inductance of the phone itself there is sufficient energy to produce a slight sound even when at the true zero. It is generally advisable to use a buzzer (as shown

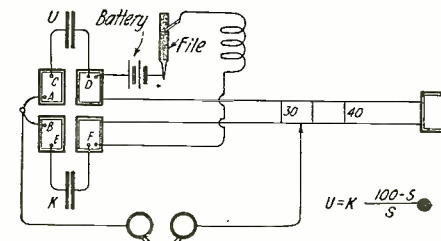

Fig. 3.—Arrangement for Comparing Capacities.

in Fig. 2), but the writer uses a microphone with a ticking watch, Fig. 4, or a brass rod rubbed on a file, as shown in Fig. 3. The reason for this preference is that buzzers are noisy things and it is difficult to determine if the sound be coming direct from the buzzer or from the phones. If a buzzer is used it should be placed in a sound-proof box as far away as possible.

Fig. 2 shows the fit-up for comparing resistances; Fig. 3 shows the fit-up for comparing capacities; Fig. 4 shows the fit-up for comparing inductances; Fig. 5 shows the fit-up for comparing the resistance of a pair of phones, using the phones under the test to make the observation. Besides these tests there are a number of others which can be made, but there are also limitations to its use. For instance, it is not possible to get true readings when comparing the resistance of a coil of wire inductively wound (such as wire purchased wound in a coil or on a bobbin) with a standard resistance non-inductively wound. In this case the measurements would be complicated by the introduction of inter-coil capacity and inductance. If, however, it is desired to test two similar bobbins wound with the same number of turns of similar wire no system of measurement could be better.

In making comparisons very large differ-

ences between the standard and the piece under test should be avoided and the connectors should be thick and short and not curled up into spirals.

In using the instrument connected with the looped wire, as described above, should the resistance be greater or the capacity less in the article under test than the standard against which it is being compared the slider will be on the wire furthest away from the object being tested, and the reading will be more than 50, as shown by the dotted connection of the slider in Fig. 5, where the reading is 64 and  $100 - S = 36$ . In the formula given by the side of Figs. 2, 3, 4 and 5, U is the unknown value and K is the known value and S the reading on the scale.

The important points in the construction to be observed are perfection of insulation, massive plates and terminals, which must be securely fixed to the insulation in such a manner that the woodwork does not touch the metal work, and that the resistance wire be not stretched when straining it in position.

Fig. 2 shows a buzzer used to produce an interrupted current in the phones. Fig. 3 shows a file and brass rod. Fig. 4 shows

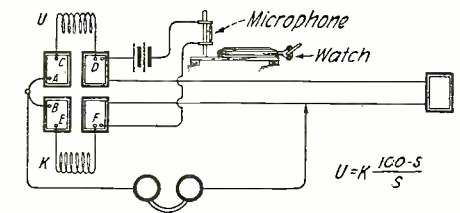

Fig. 4.—Arrangement for Comparing Inductances.

a microphone and watch for the same purpose.

A single cell of a flash light battery that is past use may be used to energize the circuits in the methods shown in Figs. 3 and 4, but two or three cells will probably be required to actuate the buzzer.

As already explained, it is not possible to compare one kind of resistance with another. It is, therefore, better to test the phones against another pair the resistance of which is known, and as a further refinement there should not be a greater difference in resistance than 1 to 2 between them.

In Fig. 5 the observation is made by finding a point on the wire at which the intensity of the sound remains unchanged, when the plates F and D are shorted, and to get the best results it is advisable to use an interrupted or alternating current in the circuit (not shown in the drawing). It requires a keen sense of hearing to detect a slight difference in intensity of sound, so it is advisable to either test the phones against another pair, the resistance using the connections shown in Fig. 2, and another pair of phones to make the test, or to disconnect one earpiece at a time and test the resistance of that whilst using the remaining earpiece to make the test.

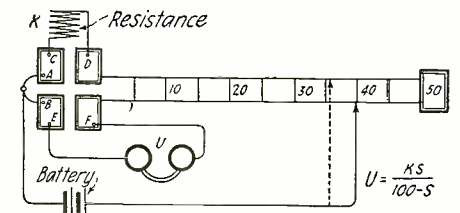

Fig. 5.—Testing the Resistance of a Pair of Phones.

# An Attachment for Converting A Standard Morse Key Into A Side-Motion Key

By JOHN M. AVERY\*

A RATHER desirable apparatus at any busy radio station is what has been variously termed a double-speed key, radio bug, or "cootie." The side motion of this type of key permits telegraphing with at least 75 per cent greater ease than that of a normal Morse key, while twice the number of words can be sent with the same amount of labor. It is not infrequent that operators, working high-speed or heavy traffic circuits, are afflicted with a variety of writer's cramp, known in the "game" as a "Glass Arm," in which case the use of a key employing some motion other than the up-and-down of the normal Morse type is imperative. The writer became afflicted with a glass-arm several years ago, which in spite of massage and electric treatment, continued to grow rapidly worse. Side-motion keys of both the automatic, or Vibroplex, and the "double-speed" types were resorted to, the "double-speed" type finding greater favor due to easier control of greatly varying transmission speeds; what might be termed flexibility of control. Many operators of both foreign and American vessels who dropped in while the writer was operating were very much interested in the method of handling this type of key, due interest being fostered, no doubt, by a total lack of any information on this point in current radio literature, or even in the catalogs of dealers supplying ready-made keys of this type. Before detailing the actual construction of this device, the writer believes a few words concerning the operation of it will not be amiss.

Keys of this type usually have a flat insulated knob to be gripped by the fingers, the motion of which either to the right or to the left will close the circuit. The length of time that the knob is held either to the left or to the right determines the length of the dots and dashes in the characters. (This is radically different from the operation of the automatic or Vibroplex type of key in which dots are made by holding the knob to one side and dashes by holding it to the other.) In forming the characters the key knob is "wig-wagged" from side to side, making the dots and dashes at either side. No fixed rule can be formulated as to which side is the correct one for starting a letter, and the operator practicing with a double action key for the first time should ascertain which side he finds the easiest for the commencement of each individual letter, and then continue to start that letter from its side, regardless of the position of the key lever at the termination of the preceding letter. Telegraphic "experts," particularly those teaching in the many telegraph schools, have propounded the rule that for any type of telegraph key the wrist is to be held high up from the operating desk, with only the fleshy part of the arm resting on it, and using the muscles in the main part of the arm—never those of the wrist. From personal observation, however, the writer would say the correct method for a side-motion key is to rest either the fore-arm or the wrist on the operating table, as is found most comfortable, and holding the knob *very loosely* between the thumb and the first finger, or between the thumb on one side and the tips of the first and second fingers on the other, form the characters with an easy rolling, swinging motion of either the fore-arm or the wrist. Space the dots and dashes well, which is easily possible if the key knob is allowed sufficient side play before the circuit is closed,

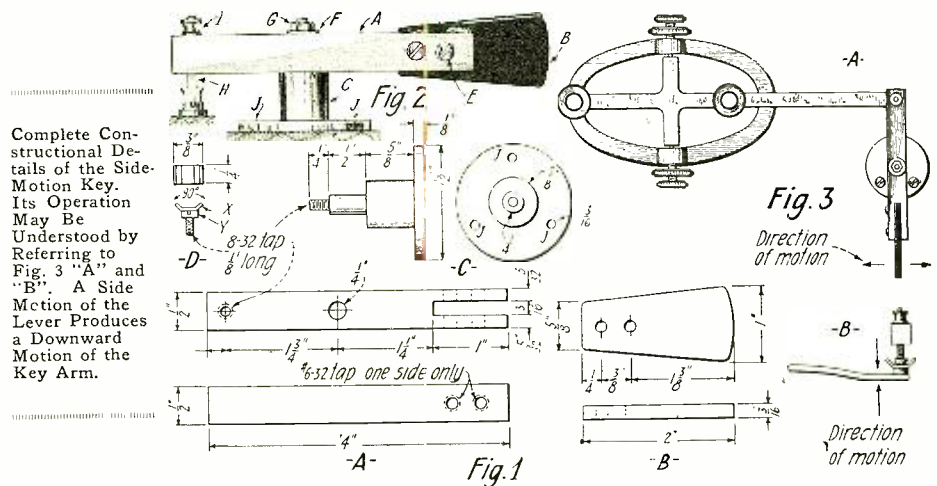

and don't attempt to compete with an automatic machine sender until an even, musically swinging, moderate speed of sending is perfected.

The accompanying drawings give the details of an attachment for converting any normal Morse key into such a double-action key, but possessing some features not contained in any ready-made article on the market. Chief among them is that if the key knob be released suddenly at either side it will resume its normal neutral center position immediately, and not vibrate against the contact of the opposite side forming a partial dot. Through the convenient design of the apparatus in its attachment to a normal Morse key, the spring tension, spacing of the contacts, distance of side motion, and amount of side play before engaging with the Morse key lever are all easily and closely adjustable.

In Fig. 3-A is represented a plan view of the relationship between the Morse key and the side motion attachment. The Morse key is unaltered, with the single exception of the removal of its knob and the substitution of a small "half-moon" shaped piece of brass in its place. The rear end of the attachment's lever has a round head machine screw projecting from the lower side, adjustable as to length, and engaging with the "half-moon" as shown in Fig. 3-B. Here it will be seen how any side motion of the lever of the Cootie attachment will cause a corresponding up and down movement of the Morse key lever, the Morse key being depressed regardless of the direction of motion of the lever of the attachment. In Fig. 1 we find some practical dimensions for the construction of the attachment, all parts with the exception of the control knob being made of brass. Part A, the lever proper, is made from one-half inch square stock. Note that the front end of the lever having a slot for the insertion of the knob is tapped for 6-32 standard machine screws at one side only, the corresponding opposite holes easily passing the screws, and forming a vise-like grip for the knob. The hole in the rear end is drilled and tapped for a normal 8-32 standard machine screw, while the hole in the center of the lever must be very carefully drilled to a quarter-inch diameter. Any burr around the edge of this hole must be carefully removed with a fine flat file. Part C, the bearing, is to be turned from a piece of one and a half inch brass rod, the dimension requiring the greatest accuracy being that portion which acts as a pivot for the lever. It will be

noted that this has dimensions of  $\frac{1}{4}$ " by  $\frac{1}{2}$ ", both of which must compare closely with the bore of the hole in the lever and the width of the lever at this point, in order that an easily turning bearing result, with no up and down "wobble."

The "half-moon" is most easily made by filing flat the head of a  $\frac{1}{8}$ " 8-32 machine screw, and soldering to it a piece of strip brass of the dimensions shown. Referring to the lever assembly drawing of Fig. 2, a washer and an 8-32 hexagonal nut complete the bearing construction. Two  $\frac{1}{2}$ " 6-32 machine screws bind the Bakelite knob in place as at "E." A  $1\frac{1}{8}$ " 8-32 round head screw is passed through the hole tapped in the rear end of the lever as at "H" and its adjustment secured with a small battery terminal nut "I". The completed side motion attachment is screwed down on the operating table at right angles to the Morse key as shown in Fig. 3-A by means of small wood screws passed through the holes in the base "J". Adjustment is then made both with the adjustment screws of the Morse key and the screw at the rear of the Cootie lever so that the circuit is closed with about  $\frac{1}{8}$ " or  $3/16$ " lateral motion of the Bakelite knob, after which the spring tension is adjusted to suit. If the motion is not perfectly smooth and easy at first adjust the angle of the "half-moon," which is easily done with a pair of pliers. A drop of machine oil at this point and at the center pivot are further aids to smooth action.

## An Improvement

By B. BARTZOFF

THE April-May, 1922, issue of RADIO NEWS contained an interesting description of "An Easily Constructed 180-800 Meter Regenerative Receiver." The circuit appeared so simple that I decided to construct a similar receiver.

By deviating from the constructional details, I managed to simplify the construction and improve reception greatly.

Instead of constructing the special inductance, an old two-slide tuning coil was employed. There were 125 turns of No. 20 D.C.C. wire on the form which was about 3 inches in diameter. As the circuit requires two variable inductances wound adjacently to each other, it was necessary to make a few minor changes in the tuner.

(Continued on page 1731)

\*Tropical Radio Telegraph Co.

# A Specially Designed Broadcast Receiver

By FRED A. BURGESS

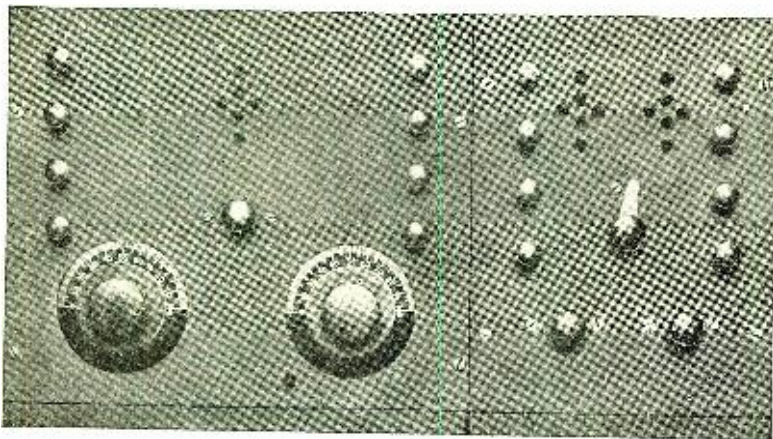

Front View of the Tuner and Two Stage Amplifier. The Tuner Has But Two Controls. A Two Point Switch Cuts the Second Amplifier in or Out of the Circuit.

**T**HE ideal receiving set would be one that was infinitely sensitive and infinitely selective, and required only one adjustment. Of course, this is impossible of fulfilment, but it should be the aim of receiving set builders to make their products approach, as nearly as possible, to this hypothetical ideal.

An attempt should be made to secure a minimum of tuning controls, provided, of course, that this does not entail a sacrifice of operating efficiency. The usual method of simplifying the controls of a regenerative receiver is to make it a single circuit type of tuner. This at one stroke eliminates two controls, the coupling between primary and secondary and the tuning of the primary. However, an inherent failing of the single circuit set is its lack of selectivity. It does not offer the same possibilities for separating stations on different wave-lengths, and hence considerable interference is caused from hearing several different kinds of music or signals at the same time.

In the present article there will be described a receiving set that combines the simplicity of controls of a single circuit tuner with the selectivity of a more complicated type of set. The aim of the designer has been to reduce all controls to a minimum so that the set can be easily operated by the most inexperienced novice. In this set only two controls are required (the tuning adjustment and the feed-back or regeneration adjustment) so that it possesses the operating simplicity of the best single circuit tuner. Yet it is not a single circuit tuner, and, therefore, possesses the selectivity only found in an inductively coupled set.

This combination is made possible by employing the untuned primary, or shock-excitation, system of reception. Not only does

Photos of the set in question are shown in Figs. 1 and 2. It will be noticed that the complete outfit is housed in two separate cabinets. The left hand cabinet contains the detector and tuning apparatus, and the right hand cabinet contains a two-step audio frequency amplifier. Both cabinets are made of quarter cut fumed oak  $\frac{1}{4}$ " thick. The tuning and detecting cabinet is 11" long, 10" high, and 8" deep. The amplifying cabinet is 7" long, 10" high, and 8" deep. The lid of each cabinet hinges back,

knob midway between these two dials operates the detecting tube filament rheostat. Directly above this knob, six small holes are drilled through the panel in a symmetrical arrangement so that the operator may observe the filament brightness of the tube.

On the panel of the amplifying cabinet are mounted eight binding posts, two rheostat knobs and a two-point rotary switch.

One of the features of this amplifier is that expensive plugs and jacks are not required to change the phones from the one-step amplifier to the two-step amplifier and vice versa. This is accomplished very cheaply and efficiently by the two-point rotary switch that can be seen in the center of the amplifier panel. The two rheostat knobs are in the lower half of the panel. In the upper half of the panel, directly above these knobs, are two groups of small holes for observing the filament brightness of the amplifying tubes. The two upper binding posts on the left hand side of the amplifier panel are for the input (from the detector) while the lower two are for a 45-volt "B" battery. The two upper binding posts on the right hand side are for the output (to phones or loud-speaker) and the lower two are for the six-volt storage battery.

The tuning coils for this simplified receiver can be made from a variometer and a small cardboard tube. An ordinary var-

Interior Photo of the Same Set. A .001 Mfd. Variable Condenser Is Used in This Set But One of .0005 Mfd. Was Found Sufficient.

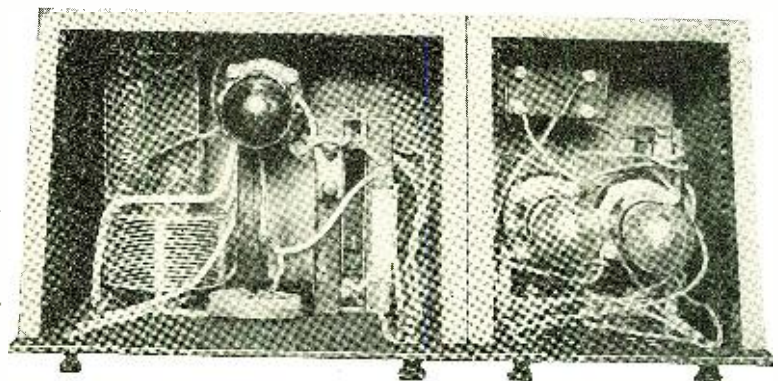

allowing easy access to the interior for changing tubes, etc. The front panels of both cabinets are of hand-grained condensite-celoron  $\frac{1}{8}$ " thick.

On the panel of the tuning and detecting cabinet there are mounted eight binding posts, two indicating dials, and a rheostat knob. The two upper binding posts on the left hand side of the panel are for the aerial and ground; the lower two are for a six-volt storage battery. The two upper binding posts on the right hand side of the tun-

ing and detecting cabinet there are mounted eight binding posts, two indicating dials, and a rheostat knob. The two upper binding posts on the left hand side of the panel are for the aerial and ground; the lower two are for a six-volt storage battery. The two upper binding posts on the right hand side of the tuner, having about 40 or 50 turns of wire on both rotor and stator, should be bought at a radio supply store. Then you must obtain a cardboard tube 2" long and of just sufficient diameter to fit snugly into the hole in the variometer stator. Glue one end of the cardboard tube firmly to the stator, as shown in Fig. 3. On the end of this cardboard tube nearest the variometer wind 26 turns of No. 22 D.C.C. wire. This acts as the secondary of the set. Care must be taken to make sure that the wire on the secondary is wound in the same direction

(Continued on page 1724)

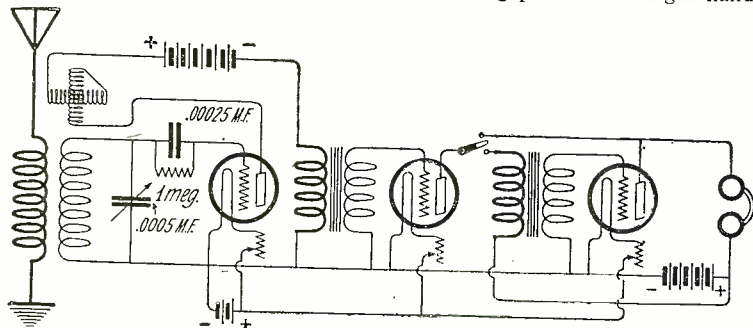

Circuit Diagram of the Tuner and Amplifier Units. The Variometer Is Coupled to the Secondary

this system eliminate the primary tuning control, but also it does away with the coupling adjustment between primary and secondary. The controls of the set then resolve themselves into two adjustable pieces of apparatus, a secondary tuning condenser and a variometer for regeneration.

ing and detecting panel are for the output (to the amplifier); while the lower two are for a 22½-volt "B" battery. The left hand indicating dial controls a .0005 mfd. variable condenser for tuning purposes and the right hand dial controls the rotor of a variometer for regenerating purposes. The

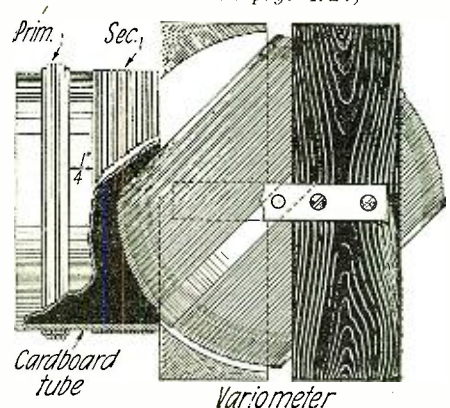

Details of the Tuning Inductances. The Cardboard Tube Is Glued to the Stator of the Variometer.



# An Easily Constructed Variometer

By DAVID A. GLUSHAK

THE following article covers a concise description of a variometer that is unusually efficient and is very easy to make.

The materials necessary are as follows:

	Cost
1 cigar box.....	\$.00
1 dowel, size $\frac{5}{8}$ " in diameter, 36" long .....	.03
2 doz. brass screws or brass brads .....	.10
1 brass shaft, 6" long $\frac{1}{4}$ " diameter .....	.05
$\frac{1}{2}$ lb. No. 20 cotton covered wire .....	.25

Total cost ..... \$.43

Fig. 1 shows the front and back pieces. Two pieces of the cigar box are tacked together and cut out as shown. This can be done either by knife or by a small scroll saw that can be purchased in any ten-cent store.

Fig. 2 shows the front and rear of

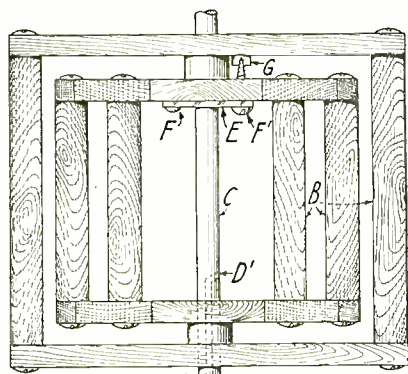

Fig. 3

The Completed Forms are Mounted on a Wood or Brass Shaft. The Windings if Shown, would be Parallel With the Dowels.

the rotor which can also be cut out together. It is better that both pieces be cut together as a more accurate job can be done.

Six dowels are cut, each  $2\frac{1}{4}$ " or slightly more for the rotor.

Six dowels are cut, each  $3\frac{1}{4}$ " or slightly less for the frame.

The best procedure is to make the rotor dowels first and after the rotor is assembled the frame dowels should be made to allow just enough clearance.

In assembling this variometer only brass screws or nails should be used.

The only difficult thing to make is the shaft. I made one variometer using a wooden shaft and found that it was not sensitive enough as it did not stay exactly in place. Also the wood shaft would hang at times. My other variometers have the brass shaft. It is necessary to drill a hole  $\frac{1}{8}$ " or so in diameter in one end of the shaft for about  $\frac{3}{4}$ " in depth, just to get inside of the rotor as shown by letter D in Fig. 3. Then a hole D' is drilled through the side to the hole D.

A piece of brass E, Fig. 3, is soldered to the shaft and two holes, F and F', are drilled in this strip. One end of the rotor is then screwed to the shaft by means of screws F and F', being longer and projecting through the wood of the rotor. This projection is made to hit against a piece of brass G, that is nailed on to the front frame to limit the rotation of the rotor.

The rotor is first wired. The wire is led in through hole D'D, Fig. 3, and then wound continuously around the rotor making 30 turns on each half. It will be necessary to start the wiring from each end and join the wires in the middle. Both leads come through the hole D'D.

The frame is wired as follows: Drill a small hole through the dowel at point 1, Fig. 3, and at point 5, Fig. 1 and run the

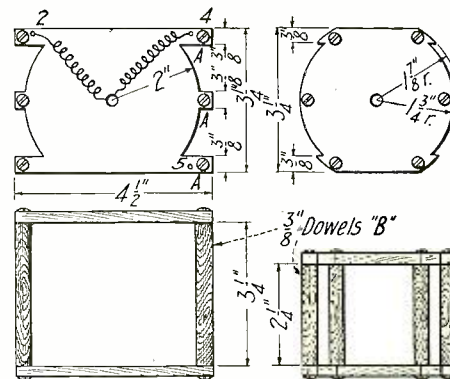

Fig. 1

Fig. 2

Details of the Front and End Pieces of the Variometer Form. These are Made of Cigar Box Wood.

end of the wire through this hole. Knot one end of it and wire one-half of the frame with 30 turns of wire.

Next drill a similar hole in dowel at point 2, Fig. 3, on side 3, Fig. 1, and start winding from there. Solder the two wires in the center. Be careful in winding the two halves that the wire is wound in the same direction. At point 5, Fig. 1, put one binding post and solder one lead to it. At point 4 put another binding post and coil one of the leads from the rotor and solder. Coil the other lead of the rotor and bring it down to point 3, and bring the other frame lead from point 2 around to point 3 and solder them together to the brass screw.

In making this variometer the clearance should be as little as possible and a very excellent variometer, both in appearance and efficiency, can thus be made. The wood should be given one or two coats of varnish to keep it from warping.

# New Points for the Super-Sensitive Receiver

By E. H. Lerchen

Since writing an article on a "Super-Sensitive Receiver" for the November issue of RADIO NEWS and since the hook-up was printed I have received letters from all parts of the United States and Canada from people who have built this set and are obtaining such wonderful results on DX work, therefore, I deem it advisable to give further pointers for the successful operation of this set, inasmuch as some of those who have built the set are writing in for more information.

A diagram is shown herein, giving the proper method of adding two steps of amplification to this set, as most of the inquiries are of this type.

To those who are having trouble in tuning out the broadcasting stations, operating at the same time on 360 and 400 meters, I wish to say that with my set I am able to tune out either WJZ or WOR with only two points change on the 43 plate condenser in spite of the fact that I am only two miles away from either of these stations. This is due to the fact that the spider web inductances are wound in accordance with the natural wave length of the aerial. A Vernier condenser should be shunted around the 43 plate condenser. The spider web coils should also be placed as far away from the primary inductance in the set as possible, for best results, and the set operates much better without a grid leak or condenser.

When adding amplification on to this set, do not forget to shunt a .005 mfd. condenser directly across the primary of the first transformer as this will cause the detector tube to oscillate in the best manner. The transformers should be about a 4 to 1 ratio in the first step and a 10 to 1 ratio in the second step. It is also better to use a softer amplifying tube in the first step and use your hardest amplifying tube in the second step.

You will also find that by using an amplifying tube as a detector in this set, and putting 45 volts on the plate that for local

work the volume of sound produced with two steps of amplification and a pair of phones on an ordinary horn will produce signals loud enough to be heard over 150 feet from the horn, either code or music, and plain enough to be understood, also much clearer than by using a loud speaker. However, for long distance work the detector tube will work much better than the amplifying tube.

The loop used in conjunction with the set heretofore described was 18" square wound with 12 turns of wire spaced  $\frac{1}{2}$ " between turns.

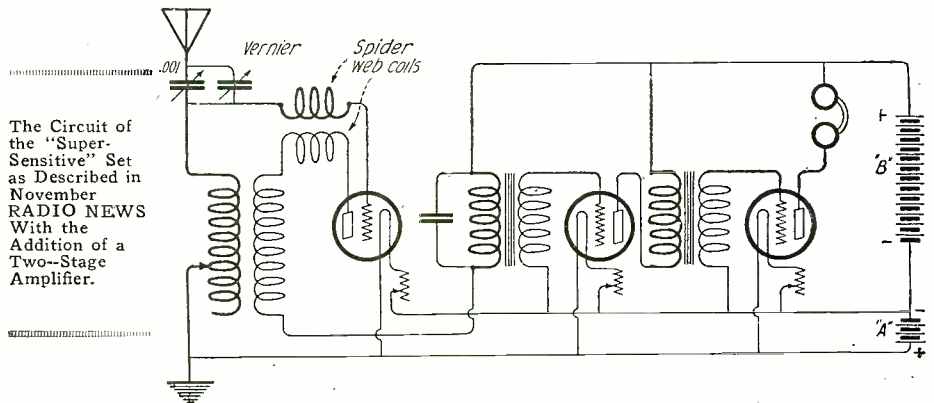

The Circuit of the "Super-Sensitive" Set as Described in November RADIO NEWS With the Addition of a Two-Stage Amplifier.



**T**HIS Department is open to all readers. It matters not whether subscribers or not. All photos are judged for best arrangement and efficiency of the apparatus, neatness of connections and general appearance. In order to increase the interest in this department, we prefer to publish photographs of stations accompanied by a picture of the owner.

We prefer dark photos to light ones. The prize winning pictures must be on prints not smaller than 5 x 7". We cannot reproduce pictures smaller than 3½ x 3½". All pictures must bear name and address written in ink on the back. A letter of not less than 100 words giving full description of the station, aerial equipment, etc., must accompany the pictures.

**PRIZES:** One first monthly prize of \$5.00. All other pictures will be paid for at the rate of \$2.00 each.

## Station, 8AB At Port Huron, Mich.

### This Month's Prize Winner

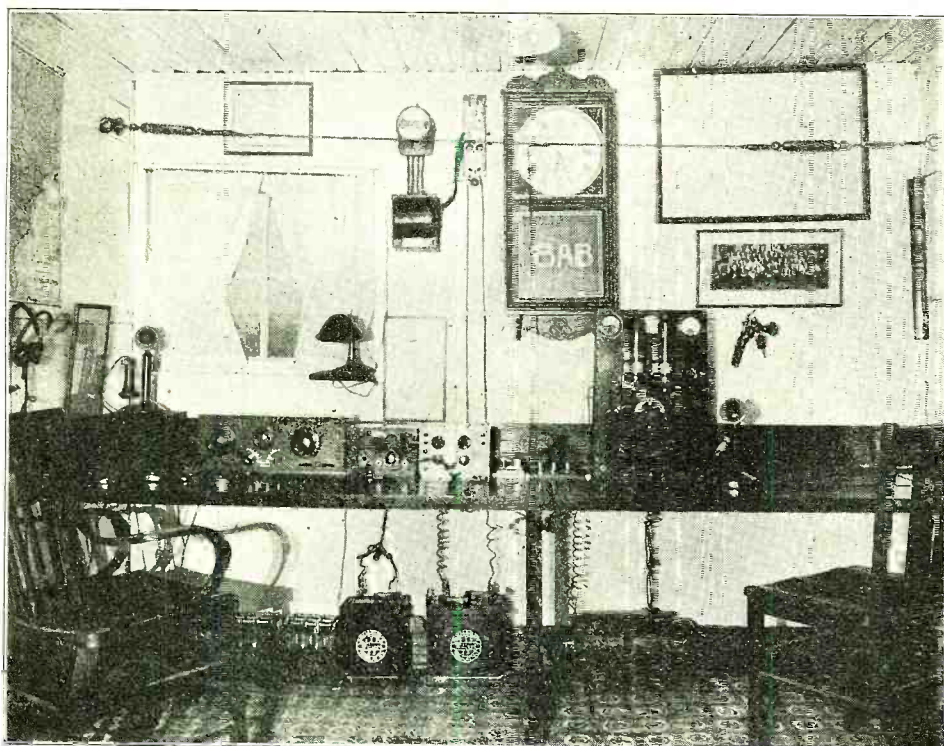

"Holy smoke" said the broadcast listener, "So this is an amateur station, and I expected to see a spark coil!" We are inclined to orate ourselves. 8AB is one of the best we have seen in some time. How about it?

## B. L. ELFMAN'S Station 3CW

AT PHILADELPHIA, PA.

**T**HE photo below shows very clearly the apparatus of 3CW which is all home made.

The change over switch in the center controls all leads to and from the station. The receiving set consists of a short wave variometer regenerative tuner, and is properly shielded, with copper. The tuner is used in conjunction with a four stage amplifier.

With this set remarkable results have been obtained. It is very selective and can be made to oscillate at most any wave. Amateurs in New Mexico come in with great volume.

The pre-war spark set of ½ K. W. was substituted by a 10 watt C.W. set. High voltage is obtained from a 110 volt A. C. line, which is stepped up with an Acme 200 watt transformer and rectified with a 10 jar chemical rectifier. This rectifier has been very satisfactory and has never over-heated on high load. The voltage supplied from the transformer is between 350 and 500 volts D. C.

The radio frequency choke is an oat meal box wound with a No. 22 D.C.C. wire. The inductance has 30 turns of No. 12 bare wire on a fibre tube 5 in. in diameter. The grid leaks are a total of 15,000 ohms, a Ward-Leonard and Radio Corporation being used. The grid condenser is .0017 mfd. of the Murdock molded type. The grid leak is con-

**A**BOVE is a picture of radio station, 8AB. This station has an ideal location being about 60 miles outside of Detroit on the lower end of Lake Huron and very little interference is experienced from amateur QRM, thus permitting this station to handle radio traffic with great speed. The receiving set consists of a Grebe special tuner, a Federal three-stage amplifier and Federal receivers.

The transmitter consists of two 50-watt tubes with 1000 volts on the plates. The voltage supplied to the station is taken from a separate transformer, insuring excellent voltage regulations. The antenna system consists of a six-wire cage, 55" high and 45" long. The counterpoise is of six wires, approximately 10' from the ground.

This station has worked Los Angeles, Aberdeen, Washington and also Honolulu, Hawaii.

We have heard much about the French station, 8AB, and would like to let the people of the United States get a look at American 8AB.

CHARLES R. THOMPSON,  
ROY GAITING,  
IRVING BELL,  
Port Huron, Michigan.



The Receiver of This Station is One of the Three-circuit Regenerative Variety, Employed With Four Stages of Audio Frequency Amplification. The C.W. Set is Seen at the Extreme Right. Phone is Used for Local Work.

nected across the condenser instead of from grid to filament, as higher radiation was obtained. For telephone work one modulator is used with an Acme modulation transformer. A "C" battery is absolutely necessary to obtain clear modulation. The phone has been reported up to 50 miles.

The dial in the center controls the wave to be transmitted on, from 190 to 220 meters. Signals have been reported as well on the short waves as the long. The jacks on the panel are for the insertion of a microphone of the Western Electric type. The two switches control the input and high or low power transmission.

This set has been reported up to 1500 miles, and has worked nearly every district.

The antenna consists of five wires 65 ft. long and 75 ft. high. A metal roof is used as a counterpoise and has proven very satisfactory.

The idea in construction was efficiency and compactness.

Bernard L. Elfman,  
Philadelphia, Pa.

**5EI RE-ISSUED**

The radio call, 5EI, formerly issued to E. K. Pelster of Dallas, Texas, has been re-issued to Forrest H. Ward, Park Place, Route No. 1, Box 594, Houston, Texas.

At the present time, Mr. Ward is operating a 1/2 K. W. spark station, but expects to install a C. W. transmitter in the near future.

**1EX**

The call 1EX was recently re-issued to Mr. R. H. Fowler, 8 Quentin Street, Whitneyville, Connecticut. 1EX is using a 10 watt C. W. transmitter and would appreciate a card from anyone who hears him.

**THIS IS A BIRD**

We leave this clipping to the imagination of our readers: "9:55 to 10 P. M.—Arlington time signals—Feather forecast."

We Should Like to Have at Our Disposal This Array of Apparatus. This Receiving Set Includes Radio and Audio Frequency Amplification.

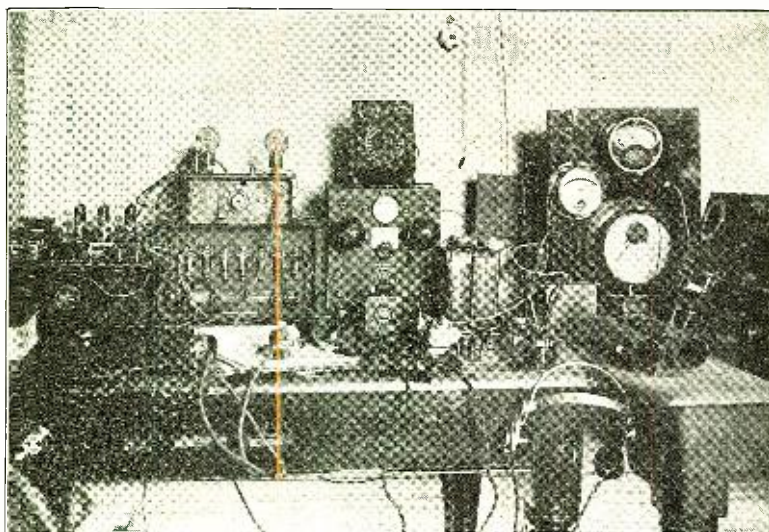

**M. Ellison's Station—English 2JP**

This set is the work of an English Amateur experimenter who has succeeded in getting record results despite severe Government restrictions.

On the extreme left of the photo is a Marconi type 16 Crystal receiver converted for use with three high-frequency transformer coupled valves of the ES4 type. This set tunes from 200 to 2000 meters. A switch places the Marconi six valve 55D receiver across the tuner for long distance traffic. This receiver uses Marconi V24 valves for high frequency amplification, and Q valve for detecting in conjunction with grid potentiometer shown below the valves.

Above this instrument is a home-made two-valve low-frequency amplifier for use with the three valve receiver.

On the transmitting side we have a well

made two valve phone and C. W. transmitter, using choke control over a range of wavelengths 170-210 meters. Above this is an ex-Air Force Townsend wavemeter fitted with buzzer and tuning lamp. Tuning is done on the variometer principle and the scale is calibrated to read direct.

The current is supplied to the transmitter by an ex-Govt. plane generator giving 600 and 12 volts from the commutators; speed and voltage being regulated by field current resistance of cylindrical type.

With .6 amp. in the aerial, which is inverted L type 100 feet long, C. W. has been reported O. K. in Switzerland during night transmissions. Phone is consistently heard at Aberdeen and modulation reported good from many receivers within 60 miles.

Mr. MICHAEL ELLISON, York, England.

**Calls Heard**

**HERBERT C. HOOVER JR.**, son of Secretary of Commerce, Herbert C. Hoover, is a real DX operator.

He recently achieved the unusual feat of receiving CW signals from 100 stations, in 30 states, in one evening. This was accomplished in his home at Washington, D. C. Some of the stations heard were:

- 1GV, 1II, 1RU, 1XP, 1XU, 1ZE, 1AGH, 1AGP, 1ASF, 1AYQ, 1BAS, 1BDI, 1BDQ, 1BKA, 1BKQ, 2GR, 2IG, 2ZK, 2AZC, 2BFX, 2BJO, 2BRD, 2CCD, 2CKL, 2COS. 3's too numerous!
- 4BB, 4EA, 4EK, 4JZ, 4NT, 5DA, 5DO, 5EG, 5EK, 5EO, 5ER, 5ES, 5FG, 5GA, 5HB, 5JB, 5XC,

- 5NK, 5PX, 5QY, 5SM, 5XA, 5XR, 5AAG, 5ACR, 5ADE, 6KA. 8's too numerous!
- 9CR, 9GN, 9HK, 9II, 9MU, 9PF, 9PN, 9PX, 9PW, 9UV, 9VX, 9WC, 9YB, 9ZN, 9AAP, 9AFN, 9AGH, 9AHH, 9AIP, 9AIV, 9AMY, 9AMT, 9APS, 9AOV, 9ARG, 9AWM, 9AXU, 9BDS, 9BHD, 9BIK, 9BKP, 9BVP, 9BYZ, 9CBA, 9CCV, 9CGK, 9CLN, 9CMV, 9CPY, 9DJU, 9DOJ, 9DWM, 9XAC, 9ZAF. Canadian—3CO, 3JI, 3SX, 9AI.

**STATIONS HEARD AT 2KV, BRONXVILLE, N. Y.**

- All C.W.—(1ADL), 1AGC, 1AGH, 1AJL, 1AJP, 1ALZ, 1AMS, 1ARN, 1AOJ, 1AOK, 1AOL, 1ASJ, 1AW, 1AWB, 1AWK, 1AWL, 1AXB, 1AXI, 1AYZ, 1AZW, (1BAS), 1BES,

- (1BGF), 1BGW, 1BKP, (1BKQ), 1BMS, 1BOE, (1BOD), (1BRQ), 1BSA, 1BSZ, 1BWI, 1BYG, 1BZP, 1CAC, 1CDO, (1CDR), 1CFI, 1CIV, 1CPO, 1DQ, 1EE, 1EO, 1GL, 1GV, 1II, 1JT, 1KC, (1LL), 1MA, 1QR, 1PM, (1RD), 1RN, (1XU), (1XZ), 2XQ, (2ANM), 3AAV, 3ABW, 3AFB, 3AGA, 3AIR, 3AJJ, 3ALU, 3ANS, 3APR, 3APT, 3AQR, 3ARM, 3AS, 3ATB, 3AVV, 3BDM, 3BEC, 3BFU, 3BIJ, 3BIT, 3BJY, 3BKC, 3BLF, 3BNU, 3BOB, 3BOF, 3BSS, 3BZ, 3CC, 3CE, 3CG, 3FS, 3HD, 3HS, 3HL, 3IW, 3JH, 3JI, (3LK), 3MK, 3OT, 3PZ, 3QV, 3RF, 3SM, 3SU, 3TJ, 3VW, 3WF, 3XM, 3ZO, 3ZZ, (4BX), 4CG, (4EA), 4EL, 4FT, 4GH, 4GL, 4JK, 4KL, (4NT), 4VA, 5ABY, 5DA, 5EK, 5FV, 5HK, 5IR, 5KC, 5NK, 5SM, 5SU, 5XA, 5XD, 5XT, 5ZAS, 5ZAV, 5ZB, 6EN, 6XAD, 6ZZ, 7LU, 7ZK, 7ZO, 7ZU, 8AA, 8AAF, 8AB, 8ABE, 8ACH, 8ADG, 8ADR, 8ADS, 8ADU, 8AEA, 8AEB, 8AGO, 8AHR, 8AIG, 8AIO, 8AIV, 8AJE, 8AJX, (8AJT), 8ALF, 8ALU, 8ALT, 8AMR, 8AMF, 8ANB, 8APN, (8APU), 8AOF, 8AOC, 8ATC, 8AVT, 8AWP, 8AWU, 8AXC, 8AZD, 8BDB, 8BDC, 8BEI, 8BFB, (8BFV), 8BGL, 8BIS, 8BIU, (8BKZ), 8BKH, 8BLC, 8BNJ, 8BNY, 8BRC, 8BRM, 8BSF, 8BUN, 8BUT, 8BWK, 8BZY, 8CCS, 8CEF, 8CEI, 8CGB, 8CGO, 8CGX, 8CGZ, 8CIZ, (8CKM), 8CKO, 8CMI, 8COK, (8COO), 8COL, (8CTN), 8CTT, 8CUR, 8CVE, 8CXP, 8CYT, 8DAA, 8FM, 8GS, 8HH, (8HN), 8HV, 8IB, 8II, 8IJ, 8KH, 8ML, 8OI, 8PJ, 8OK, 8SB, 8SP, 8SZ, 8TT, 8UE, 8UF, 8UK, 8VO, 8VY, 8WR, 8XE, 8ZK, 8ZW, 8ZY, 8ZZ, 9AAP, 9AAV, 9AAX, 9AFK, 9AIX, 9AJN, 9AMI, 9AMO, 9AMT, 9AMU, (9ANL), 9ANO, 9APS, 9APW, (9ARN), 9ASF, 9AZA, 9BAK, (9BBK), (9BDB), 9BDS, 9BRK, 9BRY, 9BSC, 9BZ, 9CBA, 9CHE, 9CJM, 9CNV, (9CCM), 9CP, 9CPC, 9CPY, 9CUI, 9CR, 9DCB, 9DCR, 9DFB, 9DGE, 9DIO, 9DLR, 9DPL, 9DRR, 9EI, 9EP, 9II, 9IV, 9KM, 9LC, 9QR, 9RC, 9UC, 9US, 9UU, 9VZ, 9VI, 9ZN.

Canadian: 2AF, 3DH, 3GK, 3JH, 3JK, 3JL, 9BH.

**9DHG, OSHKOSH, WIS.**

- Spark—(1cni), 2BM, (2FP), 2OM, 2SQ, 2ZS, (3ABB), 3ACV, 3AHK, 3BJ, (3CCB), 3FB, 5AQ, 5AQ, 5HU, 5IZ, 5JF, 5RO, 5QS, 5TO, (5TP), 5TU, 5UD, 5XA, 5XAC, 5YG, 5ZAG, 5ZH, 5ZR, (8ACF), (8AFG), (8AHE), 8AIB, 8AIJ, 8AIZ, 8ALT, 8AWP, (8AXN), (8BAH),

(Continued on page 1714)

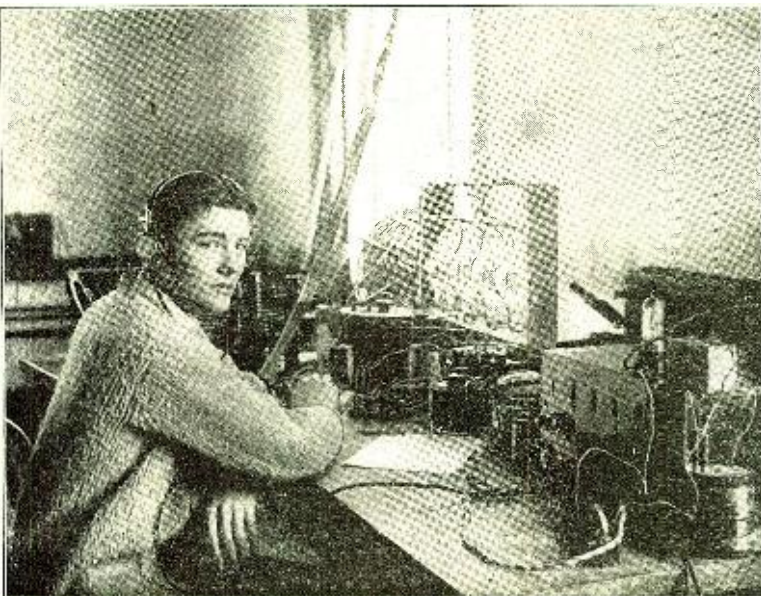

We Can See By the Wiring of This Station that Likeable Atmosphere of Ceaseless Experimentation, True of Amateurism, Which has Brought Radio to its Present Stage of Development Judging by Results, Mr. Herbert C. Hoover, Jr. Is More Than Competent.

(c) H & E.

# Report of DX From Australia

By R. SLADE and J. LOUGH

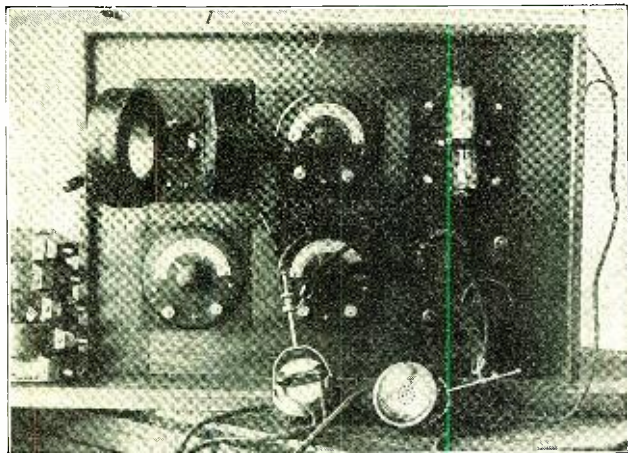

The Receiving Set that Accomplished the Remarkable Records Mentioned Herein. Note the Motion-Picture Film Binding for the DL Coils.

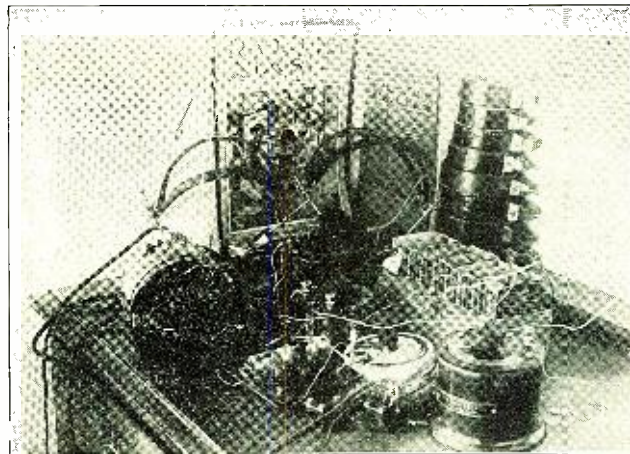

EVER since the renowned Trans-Atlantic tests I have always considered it possible to receive American amateurs here, in New Zealand. With this end in view, I have done a great deal of experimenting both with a detector alone, and with many stages of amplification. The atmosphere here seems to be particularly good for reception, for I can, with a detector alone, get the following long-wave stations, which are readable: NPG, NPN, WIL, KIE, WQK, MUU, JAA, NPM, WGG, KGI, LY, WSO, OUI, NPO, UFT, LCM, NSS, NBA, NAA, NPL, YN. With two stages of amplification these stations come in all over the room. For some reason I have never heard IDO, FL or POZ. This may be good reception, but on Nov. 5 I broke all my previous records, by receiving on a detector alone, a number of American amateurs. The night, between 8 p.m. and 11 p.m. (N.Z.M.T.), was exceptionally free from static, and at first I thought it was a "freak," that I could hear: 6KA, 9KKJ, 9BED, 9UU, 6BCR and 5PX. I heard 6BCR calling 9BED and 9KKJ and 5PX calling CQ. I could not get who 6KA called because of his fast transmission. 6KA was the first American amateur I heard, and so far he is the loudest. On Monday night static was too heavy to hear any but the faintest of signals. Tuesday night was a little better, but could only get 6KA calling 2ZO. On Wednesday I heard 6KU calling 9AMQ, 9AJP calling

CQ, and 9CNS. On Thursday—6EN, 9AWM to CQ, 6KA to 7MZ and to 1BGF. Also 6XW1, but it may have been 6XAD. The wave-length was over 200 meters, and the tuning was extremely sharp. At the time, I had the receiving set wired up on the table. I was using the primary and tickler circuit. The receiving set consists of an "Expance A" valve, of Australian make (now not made), which takes 6 volts on the filament, and 28 volts on the plate. For inductance I was using ordinary straight-wound coils, tapped, and tuned by a .001 mfd. Murdock condenser. I also use a .0005 mfd. Murdock as a grid condenser, and a .001 mfd. across the "B" battery and phones. The phones are Brandes. I enclose a photo of the set as I was using it, when I heard the amateur calls. The other photo shows the set as it was mounted in ordinary use. The Duo-Laterals are all home-made. I have often tried amplifiers for 200-meter work both radio-frequency and audio-frequency and the two combined, but never with any results. Now that I have succeeded on one valve, I will again try an amplifier. During the week I have asked other amateurs to listen in with me on my set, and they can prove my statements, as they read the call letters for themselves, and parts of messages of your progressive amateurs. I think this marks another step in the progress of the radio amateur, whose fame

is already world-wide. It proves that short-wave telegraphy is becoming a great success, and I most heartily congratulate the American amateurs on their new success. Here, in New Zealand, we are not allowed to transmit, and it is necessary to have a special permit to receive. Regulations are at present being made which propose to give us 50 watts for a first class amateur, and 5 watts for a second class, while broadcasting stations will be allowed 500 watts. There are a few small broadcasting stations, already, in New Zealand, under special license. Is it possible to arrange tests with New Zealand amateurs so that they may be heard by other amateurs beside myself. My partner is Mr. J. Lough. He has given up radio until the end of the year because of studies. In the meantime, I will do my utmost to get many more amateur calls, and report later.

R. SLADE,  
Belfield House,  
Waimataitai,  
Timaru, New Zealand.

The statements made by Mr. Slade that he has received American Amateurs are in every way correct, and we hereby sign our names as witnesses of his statements.

Signed  
J. LOUGH,  
H. B. COURTIS,  
H. V. FIRMAN.

## Some Experiments With Condenser Aerials

OF late, the condenser aerial has evidently come into its own. Reports are being received from all parts of the country ing exceptional results in reception with small compact aerials of this type. We might say that theoretically and practically

there is something in it. For this reason we are placing before our readers, several novel types of condenser aerials that, according to their owners, are superior to the common receiving antenna system. Mr. Frank F. Howe of 504 Oakland Ave., Milwaukee, has experimented with an inside aerial in conjunction with a crystal receiver. Referring to Fig. 1 it may be seen that the lead is taken from the exact center of the loop. Since the natural period of this aerial, due to its overall dimensions corresponds to a 360 meter wave, it has a peak of efficiency at this frequency. For waves other than 360 meters it is desirable to open switch A, in which case the aerial acts as a common antenna system and is more or less aperiodic. Mr. Howe states that results are poor if the aerial is not pointing in a due east and west direction. Mr. Clifford Harwood of 225 Washington St., Fall River, Mass., has been using a small loop shorted upon itself as shown in Fig. 2. Using a crystal receiver in conjunc-

tion with this arrangement he has had very favorable results. In this type the capacity is concentrated and the effective inductance of the loop is low. (Continued on page 1718)

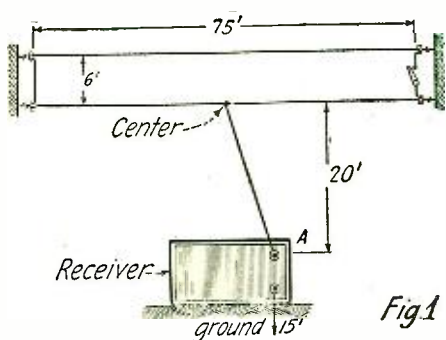

With This Aerial, the Owner Claims Coast to Coast Reception Possible, Using But One Tube.

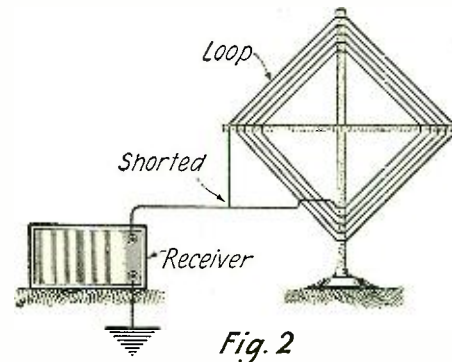

Another Form of Condenser Aerial that has Proven Very Efficient for Long Distance Reception.

# Notes On the WD-11 Tube

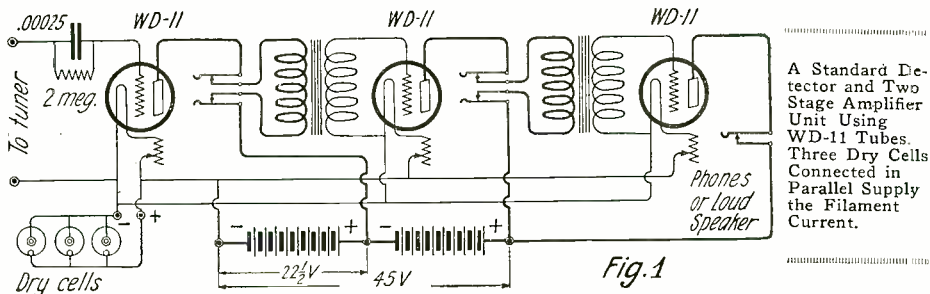

needed. This should be approximately negative three volts with 100 volts between the plate and filament. The impedance of this tube from 30 to 100 volts is approximately 20,000 ohms, which is sufficiently low for satisfactory amplification with standard transformers. Any standard make of apparatus can be used. These tubes may be used with any detector and amplifier unit, without any changes in connections.

Since three tubes are used in this case, it is required that three dry cells connected in parallel be employed as shown in Fig. 1. With this connection, the same voltage is obtained but the total amperage capacity is increased.

One dry cell should be used for each tube employed. Connect the cells in parallel, never in series. The center dry cell posts are positive. They are shown reversed in Figs. 1 and 2.

Where a greater amplification is desired, using 100 volts on the plates of the Amplifying tubes, a small three-volt flash-light battery should be connected with the negative terminals to the grid of each as in Fig. 2.

For the benefit of beginners, we will run a series of articles concerning layouts of apparatus and their circuits with the WD-11 tube in evidence.

PRIOR to the introduction of the Westinghouse WD-11 tubes, there were a number of tubes of the six-volt "A" battery variety obtainable. These varied in their characteristics. Queer as it may seem, no doubt was manifested as to the use of particular circuits. Truly, there was no necessity for this, as the circuit constants were the only important factors. However, with the marketing of the WD-11 tubes, there appeared a universal question mark. Radio editors were swamped with queries as to the circuits adaptable to this tube. For some unknown reason, the radio public is still being bamboozled into believing the necessity of special circuits. "WD-11" hook-ups are still being published.

A few notes on this so-called "Peanut" tube should eradicate present standing illusions. Aside from the use of but 1½ volts for heating the filament, there is practically no difference in the characteristics of this tube and those of the six-volt type. It is a high vacuum receiving tube and was designed for use as a detector or audio frequency amplifier. It is an excellent oscillator for small outputs such as are used for heterodyne or beat reception. The filament is oxide coated and is rated at 0.25 amperes at 1.1 volts or 0.275 watts. Ample electronic emission is obtained from the filament at this rating. Higher voltage is not only

undesirable but will prove harmful to the filament. Any standard detector circuit with grid leak and condenser is satisfactory. The values of the grid leak resistance and grid condenser capacity are not critical but a grid leak of two megohms and a condenser of .00025 M.F. is recommended. The normal plate voltage when used as a detector is 20 volts. If a voltage above 20 is available, up to 40 volts may be used with slightly increased signal strength. For operation as an amplifier, the characteristics of this tube are such that no negative grid potential is necessary. However, should a greater output be required as in the operation of a loudspeaker, a negative grid potential may be

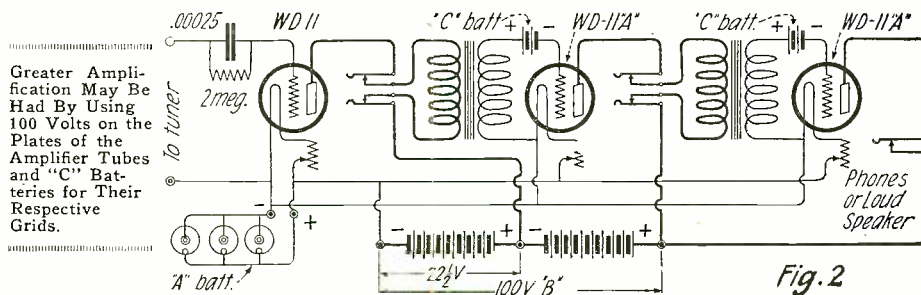

## Points On Loud Speaker Operation

By J. E. FRISBEE

THE real radio enthusiast is not satisfied until his single bulb set has grown to two stages, and until he is the proud possessor of some form of loud speaking horn. Although we all hope to some day own a horn of the Magnovox or Western Electric type, the intermediate step usually is the adapting of a Baldwin receiver to some form of horn.

The Baldwin receiver is extremely delicate and very sensitive to the electrical impulses passing through its coils, and for this reason extreme care should be taken in its use. Under no circumstances should a pair of these phones be allowed to drop on the floor, as the armature spring or the mica diaphragm is easily broken. It is well to remember that if you are located over 100 miles from a broadcasting station of any power, that it will be necessary to have two stages of amplification to make this type of a receiver an every day success.

When using a regular Baldwin phone with considerable amount of volume it is sometimes noticed that the receiver when forced beyond a certain point rattles or "chatters" and distorts the voice or music. This can be corrected by detuning the receiver, but at a corresponding reduction in signal strength. A close examination of the receiver construction will show that the entire pole pieces, armature and diaphragm are fastened to an aluminum sub-diaphragm, and do not in any part touch the sides or

bottom of the receiver case. When signals above a certain strength are passed through the receiver the mechanical energy becomes so great that the entire pole pieces and aluminum diaphragm are set into vibration, and in this way either counteract the movement of the mica diaphragm or causes it to rattle.

Between the pole pieces and the bottom of the receiver case is a space of about 1/8". If this space is filled with cloth or felt so as to stop the vibration of the unit as a whole, the problem of the "chatter" has been solved and it will be possible to obtain far greater strength of signal with perfect reproduction even if used on three stages. Cut several pieces of felt or cloth 1 1/8" long and place them in the bottom of the receiver. The layers should only be built up until on placing the unit in the case, the mica and

aluminum diaphragms will barely rest on the case edge, as they would normally. The idea is, as may be readily seen, to prevent abnormal vibrations of the entire unit but not to interfere with any weak impulse transmitted to the mica diaphragm proper.

If a receiver of this type is working satisfactorily it is well to let well enough alone and not examine the interior. If, however, any trouble develops take the unit out very carefully and hold it in a very good light. You will notice that the armature is suspended by a very small spring about the diameter of a common pin, between or rather inside the energizing coil. The clearance between the armature and the inside of the coil frame which is an associate part of the two pole pieces is very small. In several cases an iron filing or chip has found its way into the telephone case and attracted by the magnets has worked its way between the armature and the pole piece and interfered with its movement. This fault can be corrected very easily by cutting a piece of paper 3/16" wide and an inch or two long. With this as sort of a cleaner, work it back and forth on each side of the armature until in a very strong light you are unable to see any projections on its surface. Foreign particles of this sort will cut down the signal strength and in a few cases have made the unit inoperative.

With a perfect reproducing unit, the signal strength will be increased. (Continued on page 1720)

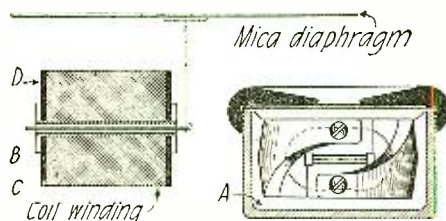

Showing the Internal Construction of the Baldwin Receiver. Foreign Matter Often Retards the Action of the Armature by Wedging in Between the Pole Pieces.

# What France Received During the Trans-Atlantic Tests

By PIERRE LOUIS, 8RRX

IT is with the hope that this short story will be of interest to the readers of RADIO NEWS that I give herewith a description of my station and the calls of the American amateurs which I received during the ten days of the tests. I regret that, at the present writing, no photographs of my outfit are ready but I hope to forward them very soon to the editors.

Needless to say, I am proud of my records as I received altogether 71 different stations among which were 28 with their code word, the transmission being steady enough to read them through long periods. Those published were received during the first seven days as, unfortunately, the log filled during the last three days was burnt accidentally. During this period, we received 51 stations among which were about 12 with their code word. The stations are as follows:

## 1ST DISTRICT

1BDJ; 1BET; 1BDT; 1GV; 1MV; 1XU; 1OR; 1AKB; 1BFS; 1CNF; 1RD; 1AGS; 1BCF; 1BG; 1CDN; 1BEP; 1CMK; 1CDO; 1AJP; 1XM; 1YK; 1ASF; 1DWS.

## 2ND DISTRICT

2EI; 2ZS; 2LT; 2AF; 2XM; 2COZ; 2ZK; 2AWL; 2GK; 2LO; 2CKR; 2BQD; 2CJN; 2BQU; 2BLP; 2BCN; 2RLC; 2COF; 2AW; 2XAO; 2RP (Spark); 2BLF; 2KA.

## 3RD DISTRICT

3HM; 3XM; 3ATU; 3BLF; 3BGT; 3BNU; 3HG; 3YO.

## 6TH DISTRICT

6KA.

## 8TH DISTRICT

8UE; 8AZ; 8BSS; 8AQQ; 8AJO; 8DXH; 8IB; 8BU; 8BR; 8AZQ; 8CYH; 8ADG; 8BK; 8BXF; 8AX; WUBA.

## 9TH DISTRICT

9OM 9DWF; 9CJC.

During the tests, Mr. Perroux and I used several receivers so as to judge their respective efficiency. One of them consisted

of two stages of radio frequency and three stages of audio frequency amplification.

## The Trans-Atlantic Tests

With the nearing of the Trans-Atlantic tests held during the latter part of December, a thrill ran through the veins of those who were to participate, and an active ambition for preparedness was evident by the methodical try-outs preceding the tests. Last year, but 33 amateurs were heard in Europe. It was hoped that the number might be doubled, but we doubt if the fondest dreams of any embraced as many as 316, the number that did succeed in "getting through." Coöperation on the part of the rest of the amateur fraternity helped a great deal in making the tests successful. No undue interference was experienced on either side of the Atlantic. This successful conclusion to a most interesting experiment is the greatest achievement the amateurs have made. The second half of the tests covering the reception of European stations in this country did not live up to the expectancy of our European brothers. However, the results supersede the records of last year. The success of both American and European amateurs in spanning the Atlantic suggests the idea of holding the air quiet to enable radio amateurs on both continents to transmit complete messages. It is the intention of the American Radio Relay League to attempt two-way Trans-Atlantic amateur radio communication and it is expected that this will be tried out in the near future. We have no doubt that this is practical and probably complete messages will soon be handled between the two continents on regular schedules.

The other one was a modified Reinartz tuner with detector and two stages of audio frequency. During the tests, we tried some other combinations but these seemed to be best for all around work. The aerial was a cage of the same shape as that of the American station, 1BCG which was described in the American radio magazines last year. This aerial was highly efficient and was used also for transmitting with a counterpoise.

During the first five days of the test on this side of the Atlantic, I used a Colpitts circuit with three 50 watt tubes in parallel. This put 2.4 amperes in the antenna and the signals from this set were reported very QSA from the north of England and the South of France. An amateur in Paris heard my station on a very small loop and two tubes, with a loudspeaker. During the last five days, I changed the circuit into a master oscillator amplifier system, using the three 50-watt tubes as amplifiers and a V.T.2 five-watt tube as master oscillator to excite the grids of the amplifying tubes. With this system, the intensity in the antenna was slightly above 2.4 amperes.

It was a big disappointment to me to learn that my signals had not been heard over there after putting in 10 days of continuous hard work.

It may be of interest to mention the fact that I receive WJZ, the broadcasting station, almost every night on one tube. I might say in concluding that the French amateurs were disappointed in not being heard over there. It was understood that the American amateurs disposed of the most efficient systems for short wave reception and were experts at using them. Here, with home made sets and without much experience on short waves we received stations using only a few watts while over there only those stations using 1KW or more were heard. We hope that before next year's tests, our signals will be copied, otherwise we shall send you a French amateur with one of our sets to show you how to receive. HI!

# Meters For That C.W. Set

By J. F. ZWEIGHAFT

THE advantages of the C.W. set are so numerous and obvious that every ham wants one. The one big disadvantage is the cost; C.W. transmission calls for a motor-generator, at least one tube, and several meters for controlling the output and input of the set. Almost everyone has a hot-wire meter left over from the days of the spark coil, so this item can be discounted. But how about the well-nigh indispensable milliammeter and the voltmeter? I have solved this problem on my own set in a very satisfactory way at a nominal cost.

The usual small ammeter that appears on the dash-board of nearly every automobile has great possibilities; don't sniff at it scornfully. It can be obtained in a junk-yard or purchased for about \$2 in a supply store. Remove the short piece of heavy wire inside, across the two binding posts and lo, you have a good milliammeter! This shunt will usually come off without any trouble and it only remains to calibrate the instrument. This is easily done in the following manner:

Take a six-volt circuit, say a storage battery, and connect it in series with a one thousand ohm receiver and your milliammeter. By Ohm's Law, the current flowing will then be .006 amperes or 6 milliamperes. Note the point indicated by the needle on the meter and, with fair accuracy, it may

be said that other points on the scale will represent proportionally different currents. For example, if, when using the apparatus described above, the needle on the ammeter pointed at 5 amperes, then "5 amperes" would indicate a current of 6 milliamps and in a like manner, "10 amperes" would indicate a current of 12 milliamps and so on. It becomes a simple matter then to draw out a new scale and paste it over the old one.

The next step is to convert our milliammeter into a volt-meter, reading from 0 to 500 volts or more. This is accomplished

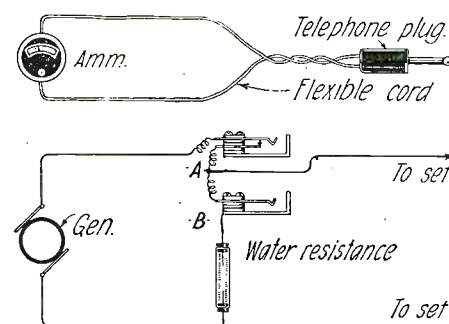

Showing Method of Plugging in the Meter. When in Jack "A" it Reads in Amperes While in Jack "B" it Functions as a Voltmeter.

quite easily by inserting a resistance in series with the instrument, but inasmuch as this resistance would have to be of the order of 50,000 ohms, it would seem an appalling task to wind it by hand. I have found that a specially arranged water resistance will answer perfectly and it has the added advantage of being adjustable so that the volt-meter can be used over a much larger range.

The resistance is simply a glass tube about 1/2" in diameter and about 5" long with a rubber stopper at each end. A small copper wire (about No. 4) is pushed through each stopper and a separate hole is left in the upper one to allow escape of the small amount of gas formed by electrolysis. The tube is now nearly filled with water, put in series with the milliammeter and an E. M. F. of say 110 volts. D. C. In all probability the needle of the milliammeter will not be deflected at all. We now make up a dilute (about 5 per cent) solution of common salt and add this to the water, drop by drop. At once the milliammeter will begin to show a deflection and when the needle has reached the "5-ampere" mark on the old scale, we call this point "110 volts." Similarly, the "10-ampere" mark will indicate 220 volts and so on. As the average automobile ammeter does not read

(Continued on page 1733)

# Measuring the Capacity Of An Aerial

By J. E. ANDERSON, M. A.

IT is sometimes desirable to know the value of the capacity of an antenna, but its measurement usually requires more apparatus than are readily available to the average amateur. If, however, only an approximate value of the effective capacity is wanted, it may easily be determined with the very simplest arrangement, providing the antenna is within range of a broadcasting station of known wave-length. If two known wave-lengths are available, not only may the effective capacity at these wave-lengths be determined, but the true capacity and the self-inductance of the aerial may be calculated. The only apparatus needed is a variable tuning coil, a crystal rectifier, and a headset.

The variable coil should be wound with heavy, well insulated copper wire, on a tube not exceeding 4" in diameter. The turns should be even and close together so that the inductance for any number of turns may be calculated with accuracy. This coil should be connected in a circuit as shown in Fig. 1. The variable point, P, in this circuit, connected in the ground lead as shown, is a metallic prober or exploring point sufficiently sharp to pierce the insulation of the wire, and is of course used to tune the circuit. This is best accomplished by beginning near the upper end of the coil and noting the strength of the signal when the circuit is completed with the sharp point. Then include more and more turns in the tuned circuit until the exact point of resonance has been found. This is facilitated by manipulating the crystal until the signal is just barely audible near the point of maximum strength. If the transmitting station of the signal is not too close to the antenna under measurement, the point of resonance may easily be found to a fraction of a turn.

Having found the exact point of resonance, count the number of whole turns and estimate the fractional turn included in the tuned circuit and calculate the inductance of this part of the coil from the dimensions of the tube and wire. This may be done from the well known formula

$$L = \frac{.03948a^2n^2K}{b} \dots\dots\dots(1)$$

in which a is the radius of the coil expressed in centimeters, n the number of turns, b the length of the coil in centimeters, and K is a factor depending on the ratio 2a/b. This factor is given in Circular 74, Bureau of Standards, but for those who have not access to this circular, a short table is given at the end of this article. Formula (1) may be put into a more practical form. The length of the coil is the number of turns multiplied by the space occupied by each turn, or the winding pitch. That is, if D is the winding pitch, b = nD. Then if d is the diameter of the coil and if all dimensions are given in inches, formula (1) takes the form

$$L = \frac{.02507d^2nK}{D} \dots\dots\dots(2)$$

This gives the inductance of the coil in microhenries.

The winding pitch for a closely wound coil is the diameter of the wire measured over the insulation, and the diameter of the coil is the outside diameter of the tube plus the diameter of the wire.

When the inductance of the coil has been calculated, its value in microhenries may be put into the formula

$$C = \frac{.2808 \lambda^2}{L} \dots\dots\dots(3)$$

which gives the effective capacity of the aerial in microfarads when the wave-length is in meters.

As a practical application of this method the author measured the capacity of the antenna of his receiving set. A coil was wound with No. 16 single cotton covered copper wire, having a winding pitch of .05485", on a tube 3.33230". The diameter of the coil, therefore, was 3.387".

A first determination was made with the 360-meter wave of WJZ. The resonance point was found at 22.5 turns. The strength of the signal on turns 22 and 23 was reduced to the threshold of audibility. No

change in the distributed capacity of the coil due to adding a few turns is negligible.

The ratio of the squares of the two wave-lengths used in the measurement is .81, L = 53.088, and L<sub>2</sub> = 69.652. Therefore, L<sub>0</sub> = 17.53 microhenries. Hence the total inductance when the circuit was tuned to 360 meters was 70.62 microhenries. This substituted in equation (3) will give C = 515.3 microfarads as the true capacity of the antenna.

The effective capacities are probably correct to 5 percent, while the self-inductance and the true capacity of the antenna may be correct to better than 10 percent.

Values of K for use in Formulae (1) and (2)

2a/b	K	2a/b	K	2a/b	K	2a/b	K	2a/b	K
.1	.9588	2.0	.5255	3.9	.3708	6.6	.2685	17.0	.1394
.2	.9201	2.1	.5137	4.0	.3654	6.8	.2633	18.0	.1336
.3	.8838	2.2	.5025	4.1	.3602	7.0	.2584	19.0	.1284
.4	.8499	2.3	.4918	4.2	.3551	7.2	.2537	20.0	.1236
.5	.8181	2.4	.4816	4.3	.3502	7.4	.2491	22.0	.1151
.6	.7885	2.5	.4719	4.4	.3455	7.6	.2448	24.0	.1078
.7	.7609	2.6	.4626	4.5	.3409	7.8	.2406	26.0	.1015
.8	.7351	2.7	.4537	4.6	.3364	8.0	.2366	28.0	.0959
.9	.7110	2.8	.4452	4.7	.3321	8.5	.2272	30.0	.0910
1.0	.6884	2.9	.4370	4.8	.3279	9.0	.2185	35.0	.0808
1.1	.6673	3.0	.4292	4.9	.3238	9.5	.2106	40.0	.0728
1.2	.6475	3.1	.4217	5.0	.3198	10.0	.2033	45.0	.0664
1.3	.6290	3.2	.4145	5.2	.3122	11.0	.1903	50.0	.0611
1.4	.6115	3.3	.4075	5.4	.3050	12.0	.1790	60.0	.0528
1.5	.5950	3.4	.4008	5.6	.2981	13.0	.1692	70.0	.0467
1.6	.5795	3.5	.3944	5.8	.2916	14.0	.1605	80.0	.0419
1.7	.5649	3.6	.3882	6.0	.2854	15.0	.1527	90.0	.0381
1.8	.5511	3.7	.3822	6.2	.2795	16.0	.1457	100.0	.0350
1.9	.5379	3.8	.3764	6.4	.2739				

difference could be detected in the volume at these two points. At 22.5, however, there was a decided maximum. This gave the following data with which to calculate the inductance: d = 3.387", n = 22.5, K = .4499, D = .05485". When these values are substituted in equation (2) we get L = 53.088 microhenries. This value is now put in equation (3), and we get C = 685.5 microfarads for the effective capacity at 360 meters.

A second determination was made with the 400-meter wave of WEAf. This transmitting station was so close to the antenna under measurement that it was difficult to determine the point of resonance closer than a whole turn with any degree of certainty. In this case it required 27 turns to tune the circuit. Then we have n = 27 and K = .4919 with which to determine the inductance, the other values remaining as in the first case. Putting these values in equation (2) gives L = 69.652 microhenries. This value put in equation (3) together with 400 for the wave-length gives C = 645.0 microfarads.

The effective capacities thus obtained depend on the wave-length because the self-inductance of the antenna was neglected. This may now be calculated as well as the true capacity of the antenna. Let the inductance of the antenna be L<sub>0</sub>. Then the total inductance in the circuit will be L<sub>0</sub> + L<sub>1</sub> for λ<sub>1</sub> and L<sub>0</sub> + L<sub>2</sub> for λ<sub>2</sub>. Equation (2) may now be written (L<sub>0</sub> + L<sub>1</sub>)C = k λ<sub>1</sub><sup>2</sup> and (L<sub>0</sub> + L<sub>2</sub>) C = k λ<sub>2</sub><sup>2</sup> in which C is the total capacity in the circuit and k is some constant. Dividing one of these equations by the other and cancelling

$$\frac{\lambda_1^2}{\lambda_2^2} = \frac{L_0 + L_1}{L_0 + L_2} \dots\dots\dots(4)$$

from which L<sub>0</sub> may be calculated. The cancellation of the C assumes that the small

## The Pacific Coast Plan

The operating schedule reprinted below, which to our minds is an excellent provision, has been adopted by the sixth radio district. We would heartily advocate such a plan for the east coast. Let us get busy and provide a similar government for the Atlantic coast district.

### THE NEW REGULATION

The authorized representatives of the Amateur and Broadcasters Organizations of the Sixth Radio District, comprising the States of California, Utah, Nevada and Arizona, at the convention held at Los Angeles on October 14th last, unanimously adopted an operating schedule for the government of their communication during the current year ending October 31st, 1923, which is given in part herewith:

Section (1): That the half-hour from 7:30 to 8:00 p. m. be reserved daily, including Sundays, for the purpose of allowing long-distance reception by Pacific Coast Stations without interference from amateur transmitters or broadcasters, and that during this half-hour listening period no transmitting by amateurs or broadcasters be carried on.

Section (2): That all Pacific Coast broadcasting and amateur stations be allowed to operate up to the hour of 7:30 p. m. daily, including Sundays.

Section (3): That no spark or damped wave amateur transmitter be operated between the hours of 7:30 and 10:00 p. m., and that the hours from 8:00 to 10:00 p. m. be devoted exclusively to broadcasting, which shall cease promptly at 10:00 o'clock.

Section (4): That amateur stations using the transmitting system emitting pure continuous waves be allowed to transmit at any  
(Continued on page 1733)

# Awards of the \$50 Radio Wrinkle Contest

## Prize Winners

### FIRST PRIZE \$25

*A Spider Web Coil Mounting*  
By MR. ROBERT SERRELL,  
110 Rue Blomet,  
Paris, France.

### SECOND PRIZE \$15

*A Tubular Variable Condenser*  
By MR. GEO. F. WISE,  
437 Butler Street,  
Philadelphia, Pa.

### THIRD PRIZE \$10

*Unique Loudspeaker*  
By MR. G. J. V. FALEY,  
Hickory Avenue,  
Tenafly, N. J.

## First Prize

### A SPIDER-WEB COIL MOUNTING By ROBERT SERRELL

The new mounting shown in the accompanying sketch makes use of two coils of spider-web construction and permits variation of their coupling. One of these coils, wired as usual, is fixed in the center of the wooden form and a tube attached to a

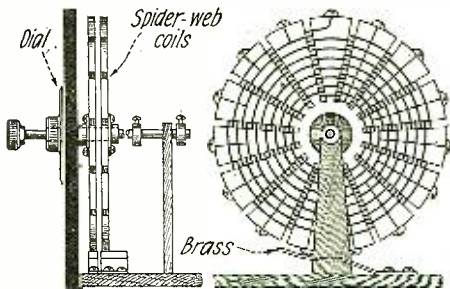

This Mounting Allows for a Rapid Adjustment of Inductance and Coupling.

knob. The other is also fixed in the center on a shaft which can slide in the tube. This coil is attached to another knob as shown in the sketch. Each coil is tapped every several turns. Tapped points made of screws are fastened on the periphery of the coil. Brass strips under these give a good contact. Turning each coil changes its corresponding inductance; in pulling or pushing a little knob, the coupling may also be varied. Connections to the end of each coil are made of flexible wire. The two inductances can be coupled in series or used as primary and secondary of a loose coupler. The model employed in my receiving set had the following constructional details: Spider-web coil forms were made of thin, hard wood 8" in diameter; 15 slots were cut in the form and wound with 195 turns of No. 22 S. C. C. wire. Each coil is tapped every 13 turns so there is a tap on each slot. A disc of brass is then soldered on the axle of the movable coil and fastened to the form by four screws. The other coil is fixed on the tube in the same way. The large knob with the 360° dial as well as the small one, were made of hard wood. The stroke of the main shaft is limited by two collars placed on each side of the end support. Contact strips are made of brass and are fixed to the cabinet by screws. The contact strip corresponding to the movable coil is wider in order to keep contact through the total variation of the movable coil. This unit will give excellent results if correctly made.

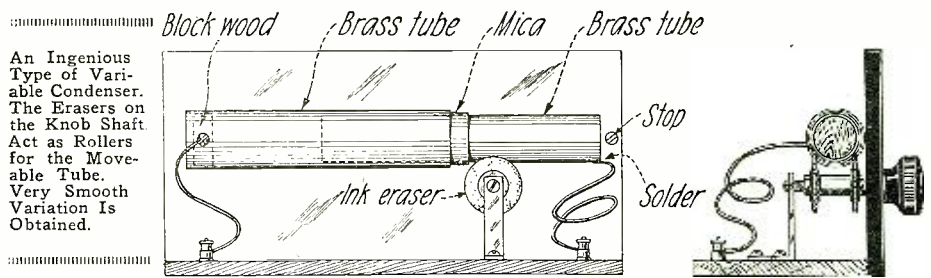

An Ingenious Type of Variable Condenser. The Erasers on the Knob Shaft Act as Rollers for the Movable Tube. Very Smooth Variation Is Obtained.

## Second Prize

### A TUBULAR VARIABLE CONDENSER By GEO. F. WISE

Following is a description of a condenser of very simple and cheap construction. The inner and outer tubes are made from casing taken from electric light fixtures, one being of slightly smaller diameter than the other. A piece of mica slightly longer than the stationary brass tube is rolled into tubular form and used as the dielectric between the two metal tubes. The rollers which support the movable tube are disc erasers. The erasers are mounted on a shaft which is supported by a metal end piece. A piece of brass tubing from a certain rod is used as a spacer for the two erasers which in turn are made rigid by two set nuts. A small screw fastened to the rear side of the panel limits the extent of movement of the tube bearing upon the rollers. The stationary tube is fastened to the panel by a screw. A small insulating disc is placed in front of this screw so that there is no possible change of the movable and stationary tubes becoming shorted. The flexible leads are brought to the binding posts shown in the rear of the panel base. This condenser has given very satisfactory results.

## Third Prize

### UNIQUE LOUDSPEAKER By G. J. V. FALEY

The following is a description of an exceptional loudspeaker: Buy or make two circles 36" in diameter of a medium or heavy weight drawing paper. Cut out a section of each from the center to outside as shown in Diagram 1. The two edges, 1 and 2, are pasted together and form a cone. When the two cones are dry and

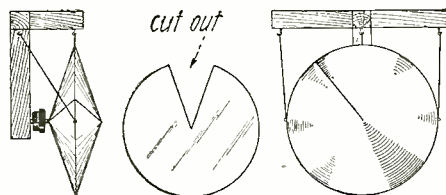

A Loudspeaker Diaphragm Made from Two Stiff Paper Cones Glued Together at Their Outer Edges.

formed, the outside edges of the two are pasted together so that the points of the cone are opposite each other as in Diagram No. 2. While this is drying, as it must be very solid, make a frame of 1"x2" wood. When the cone is thoroughly dry, it is fastened to this frame by strong thread, from the top and two sides to the screw eyes. Fastened to the frame is a Baldwin receiver of the amateur type. This is taken apart so the reed may be fastened to the point of the cone near the wood frame. With a properly constructed diaphragm of this type (diaphragm being the proper name for this cone) exceptional results will be obtained.

### CONTACT POINTS FOR PANEL SWITCHES

The lack of contact points for multipoint panel switches often makes itself felt to the amateur who must depend upon mail orders for his supplies. Neat brass points which are as good as any lathe-turned point may be made from round head brass machine screws of the 6-32 or 8-32 size. The only tools required are a vise and a file.

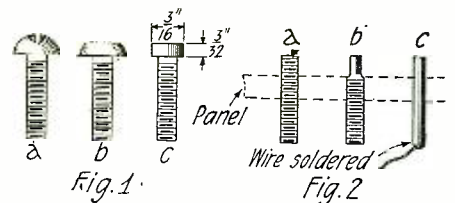

Various Sizes and Types of Switch Points Can Be Made from Ordinary Round-Head Machine Screws.

Clamp the screws in a vise between a couple of pieces of cardboard or lead sheet to prevent injury to the threads. File the head down as shown in b, Fig. 1, keeping the file at right angles to the axis of the screw. Do not go deeper than the bottom of the screw slot. Next remove all that is left of the rounded portion of the head, as shown in c, Fig. 1. This may be done accurately with the file. Polish the head with fine emery cloth and the point is finished. If one possesses an emery wheel it is a simple matter to grind the screws to shape upon that, but it is hard on the wheel.

Points made from 8/32 screws will be about 3/16 inch as shown in the figure. It is advisable to drill and tap the panel for these heads, rather than to drill a hole large enough to take thread and all.

Often smaller points than those already described are desired. Fig. 2 shows three kinds which can readily be made from materials always to be found in the amateur workshop. These tiny points are especially desirable for use upon midget sets where space is always at a premium.

The point shown in a, Fig. 2, consists simply of a short length of threaded brass rod. The end which projects through the panel front is filed square or slightly oval. The opposite end may be cut in any way, since it is immaterial whether the threads on that end are injured or not. The point shown in b, Fig. 2, is constructed in the same manner, except that it has the threads filed away on that portion which is exposed, thus giving a neater appearance to the panel.

The panel holes for mounting these points should be drilled 1/64 inch undersize, and threading should be done with the point of a taper tap. This insures a close fit for the shanks and prevents the points from loosening during operation of the set.

Sketch c, Fig. 2, shows a different kind of point which may be made in any size desired. A short length of brass rod is shaped as shown. The holes may be drilled slightly undersize and then reamed out for a close fit. Brush shellac upon the contacts before inserting them into the panel and paint the



rear of the panel around the projecting points with the same material. When the shellac has set the points will be as solid as any of the threaded kind.

Points of the type indicated at a and b, Fig. 2, when made from 6/32 screws may be placed as close as 3/16 inch center to center, or about five points per inch. By using 1/16 inch rod and exercising reasonable care in drilling the holes, the point shown in c, Fig. 2, may be placed at a distance of 1/8 inch center to center.

Connections must be soldered to all points shown in Fig. 2, since there is not space enough between them to allow using nuts and washers.

—Contributed by S. W. Watson.

**BACK MOUNTED SWITCH**

A rotary, behind-the-panel switch may be made very easily from an ordinary filament rheostat:

1st. Remove the resistance wire from the fibre.

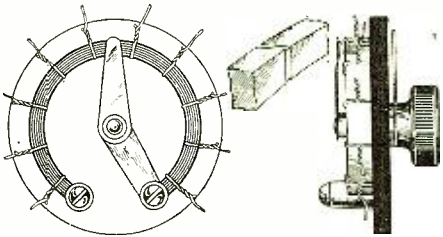

This Rheostat Has Been Converted Into a Back Mounted Panel Switch. Pieces of Heavy Wire Serve the Purpose of Switch Points.

2nd. If a six tap switch is to be made, mark off the fibre into eleven equal parts.

3rd. Beginning at one end of the fibre, cut out the front edge every second part the approximate diameter of No. 18 wire.

4th. Wind these spaces with No. 18 hard-drawn copper wire, leaving one inch for soldering at one end of each section, projecting outside.

5th. Reassemble the rheostat, and solder inductance taps to these extensions.

—Contributed by J. C. Munday.

**TAPPING COILS**

Of the many ways of taking taps off an inductance, there are few good ones that merit use. It is most convenient to use a method whereby a coil may be wound without the necessary stop to provide for a tap. The method of taking off taps, I am about to describe, allows the entire procedure to be carried out after the coil has been wound and at the same time bringing about no difficulty. After the coil is wound and fastened on the end of the tube, select the places you desire to tap. With a strong darning needle or a sharp scriber, carefully lift the wire to be tapped and slip under a piece of thin mica about 3/8"x7/16" as shown in the diagram. Scrape away insulation on the raised portion and place the lead along side of this wire; just a bit of solder and a stroke of the iron make a good contact joint.

—Contributed by F. L. Luke.

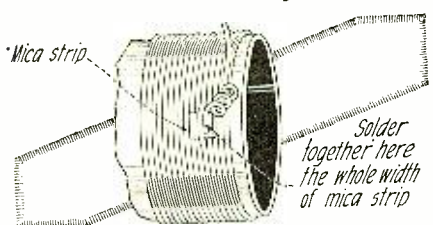

Using This Method of Procedure, a Coil May Be Fully Wound Before Providing for Taps. This Makes a Very Neat Job.

**BINDER FOR COIL WINDINGS**

Here is a hint for those amateurs who "wind their own" coils for Variocouplers, variometers, etc., on cardboard tubes. We have all been warned time and again regard-

ing the ill effects following the shellacking of such coils to keep the wire in place after it is wound, the said ill effects being capacity or a condenser-like action between the wire and the shellacked covering, which causes a certain degree of choking of the signals.

I have surmounted this difficulty in the following way. The carboard tubes are thoroughly dried in a warm oven and then given a coat of shellac both inside and out; as soon as this has dried the outside is given another coat. This should leave the surface quite glossy. The wire is then wound in the usual manner, the ends being secured through holes in the edges of the tube. The

**\$50 in Prizes**

The special prize contest for radio amateurs and beginners is held each month. There are three monthly prizes as follows:

First Prize	\$25.00
Second Prize	\$15.00
Third Prize	\$10.00
<b>Total</b>	<b>\$50.00</b>

What we desire are simple ideas exclusively for the beginner and the novice, the simpler the radio idea the better the chance to win the prize.

There are lots of valuable little stunts that you amateurs run across every month, and we mean to publish these for the benefit of the entire Radio fraternity.

If possible, a clear photograph should be sent with the idea, but if that is not possible, a good sketch will do.

This prize contest is open to everyone. All prizes will be paid upon publication. If two contestants submit the same idea, both will receive the same prize. Address all manuscripts, photos and models to 'Editor Radio Wrinkle Contest, care of this publication.

wire is then "painted" with wood alcohol, which the covering absorbs greedily, then the coil is set away to let the alcohol evaporate. Keep it away from fire. The alcohol softens the shellac and this in turn sticks to the cotton covering of the wire where it is in contact with the tube. It will be found that the wire is held securely enough for couplers and variometers also the rotors of these, but not for tuning coils with which a slider is used. I have used this method with good results.

—Contributed by Carl W. Beese.

**A VARIABLE GRID LEAK**

Many of us have old rheostats laying around whose resistance wire is either loose or broken. Why not make a variable grid leak out of one of these?

Pry out the fibre ring on which the wire

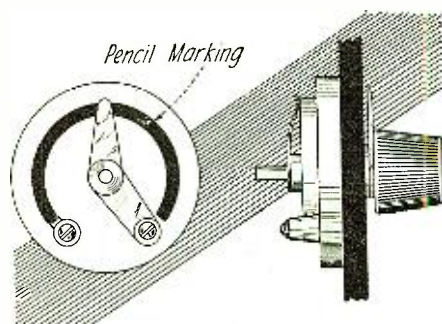

An Old Rheostat Can Be Made Into a Variable Grid Leak by removing the Resistance Wire and Making a Pencil Line on the Fibre Strip.

is wound and remove the wire. Then replace the fibre ring and glue it back into place. Next, take a very fine file and make the surface of the fibre, where the contact lever touches, very smooth and mark this surface all the way around with a pencil. Connect one end of this marking to a binding post. It will then be seen that we can vary our resistance by just turning the knob located on the other side of the panel.

—Contributed by John Burian.

**WD11 SOCKET**

Now that the Westinghouse WD11 tube is available, many amateurs will want to substitute this tube for the six volt tube and eliminate the troublesome storage battery. The only difficulty is that sockets or adapters are not easily obtained.

Since the prongs of the WD11 tube are not all the same size nor do they have the same relative connections as the other tubes, as shown in Fig. 1, the making of a socket

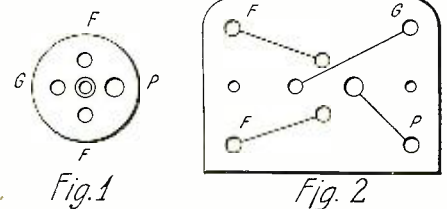

If You Have a WD-11 Tube, Here is an Easily Constructed Socket for Its Mounting. The Base Is Made from a Strip of Good Insulating Material.

is more practicable and less difficult than an adapter, which requires the base of a burned-out tube.

Take a piece of hard rubber or other insulating material 2"x3/4" or the exact size of the socket you wish to replace, if you want to substitute in a set already made. Using the standard socket for a pattern, drill four holes for binding posts and two holes for the fastening screws. Then instead of spring contacts for the prongs, take thin sheet copper or better still phosphor bronze strips and roll three of these strips an inch long around a 6 penny nail and one round a 20 penny spike. These tubes should fit the prongs snugly. Insert these four cylindrical tubes into the holes drilled at the proper places as shown in Fig. 2. Solder a piece of insulated wire to each of the tubes, under the hard rubber base and connect to proper binding post as in Fig. 2. This gives a receptacle for the WD11 tube which can be used in a new set or which will replace any standard socket without a change in wiring.

—Contributed by A. H. Albert.

**DOUBLE DUTY JACK**

While constructing a large receiving set, I decided that as my pocket-book was small and my wants large, I would wire my set so as to use only one plug for both phones and loudspeaker by using a double circuit

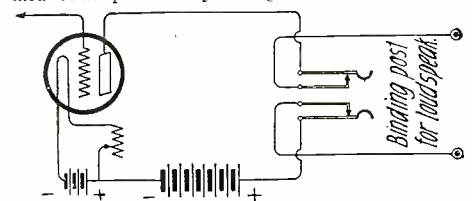

A Clever Arrangement for Using a Single Jack to Cut in Either Phones or a Loudspeaker. Only One Plug Is Required.

jack. This was easily accomplished as shown in Fig. 1. The outside springs of the jack are connected as usual. The inner springs, however, are connected to two binding posts on the panel which are the connections for the loudspeaker. By plugging in the phones, the outer springs of the jack break contact with the two inner springs which are connected to the loudspeaker. If a station has

been tuned in, the loudspeaker may be brought into use by merely pulling out the phone plug which allows the outside springs to make contact with the inner ones, thereby placing the loudspeaker directly in the circuit.—Contributed by Belgrave Gastin.

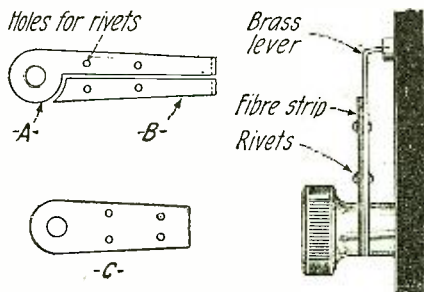

This Is Made from a Standard Switch Lever. By Insulating the Two Pieces as Shown, the Lever Will Pass from one Switch Point to the Other Without Shorting the Two. Such a Switch Proves Advantageous in Many Cases.

**A NON-SHORT-CIRCUITING SWITCH**

I hereby submit a description and diagram of a non-short-circuiting switch. The diagram shows clearly the simple method of building this novel switch. First procure a switch, remove the lever and cut in two pieces as shown in Fig. 1. Next get a strip of fibre, or some other insulating material about 1/16" thick; this should be cut two-thirds the length of the lever and 1/32" wider. Now take piece A and insulating strip C; place piece A on strip C, drill large hole first and clamp the two together by placing a screw and nut in the hole just drilled; drill the two and rivet firmly to together making sure that the edges coincide. Care should be used in attaching the other piece B, as this will form the insulator, no portions of it should touch the piece A. To do this, place the piece B on the strip and close to the edge; this should leave a gap of about 1/32". If it does not, file around until you have the desired space opposite the others and rivet. Remove the clamping screw that was placed in the large hole and reattach to knob.

I hope that this will be of some value to both amateurs and experimenters

—Contributed by Michael Coperrito

**KEY SWITCH**

I have a small brother who is very inquisitive, especially concerning my radio set. One day while he was playing with it, he burned out one of my tubes. In order to prevent this happening again I designed the key switch shown in the diagram. The diagram shows everything, for there is nothing complicated about it.

Both the key and the contacts are made with strips of spring brass. A slot was made in the panel just large enough to accommodate the key. The switch is inserted in one of the "A" battery leads.

It works very well, for my brother has not solved it yet.

—Contributed by Edwin Siddons.

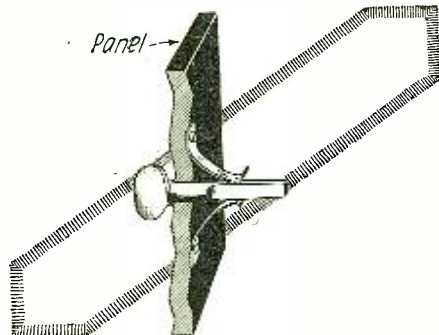

A Key That Will Fit in the Pocket When the Set Is Not in Use. An Excellent Means for Keeping the Inquisitive from Working Your Receiver. Insertion of the Key Closes the Filament Circuit.

**STORAGE BATTERY FOR 1½ VOLT TUBE**

The popularity of the Westinghouse one and one-half volt tube, type H is steadily increasing, and a great many owners of this tube arc using dry cells with which to light the filament. The disadvantage of dry cells can easily be seen in the cost and noises produced by the deterioration of the cell.

The discomforts produced by the dry cell can easily and cheaply be overcome by building a two volt storage battery of the type here described.

First secure a bottle or jam jar, six and one-half inches high, the mouth of which should be one and one-half inches wide. Procure a positive and negative plate of an old storage battery and cut each plate so as to include two sections of pasted grid, the plates can be easily cut with a hack saw. Next is a rubber stopper in which three holes are bored, one for the vent and two for the lugs. The vent is a piece of glass tubing about two inches long.

Lugs should be burned or soldered on each plate, and led through the holes in the stopper, and a binding post soldered to each one.

A battery of this type can easily be recharged at home by using a chemical rectifier.—Contributed by Joseph A. Barlock.

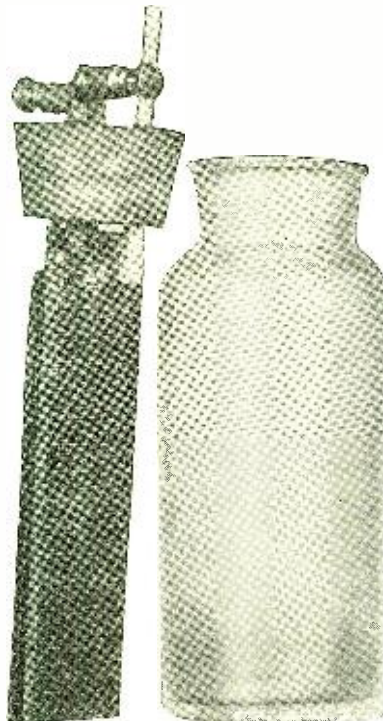

A Neat Little Storage Battery for the 1½-Volt Tube. All the Necessary Parts Are Easily Obtainable and May Be Purchased for Next to Nothing. The Plates Are Cut from Those of a Large Storage Battery. Any Garage Can Furnish Them.

**CAM ADJUSTMENT FOR SPIDER-WEB COILS**

For those using, or contemplating the use of spider-web coils the following will be found an extremely simple and efficient means of mounting them on a panel, and novel as to the method employed in providing the necessary variation of coupling.

The center or secondary coil is mounted perpendicular to the rear of the panel and is stationary. The primary and tickler coils are attached to the panel by means of small hinges. The springs K and K-1 tend to hold the coils out against the cams P and P-1 which are made of fibre or hard rubber sheet. Nuts Z and Z-1 provide the necessary pressure adjustment against springs Y and Y-1 which cause sufficient friction to keep the cams from moving of their own accord. The rapidity and extent of

variation of the primary and tickler coils depend on the curvature of the two cams. Thus, cams may be made for rapid or slow adjustment, or a combination, to meet the requirements of the circuit.

This method of mounting has the added advantage of practically eliminating disagreeable capacity effects.

—Contributed by Malcolm Gager, 8BYH.

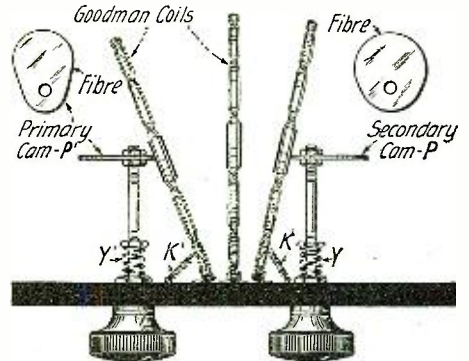

An Excellent Spider-Web Coil Mounting. Variation of the Coils is Produced by Two Small Cams. The Rapidity and Extent of Variation Depends on Their Curvature.

**JIG FOR DRILLING SWITCH POINT HOLES**

I am submitting the enclosed idea for locating and drilling the holes in a panel for switch contact points true in radius and of equal distances apart.

Take a piece of sheet brass about 1/32" in thickness, and of a length according to the radius to be used, and 3/4" wide.

Scratch a line through the center, A, prick mark point, B, set one point of dividers at B and scribe arc, C, of the radius to be used.

Prick mark the points, D and D 1, which are centers of contact points, and drill holes through the plate at these points, B, D, and D1, using same size drill as for contact points.

To use, drill hole through panel where switch is to be located, put switch or a contact point through hole B and in hole just drilled in panel. If an even number of holes are to be drilled set plate as in cut, placing drill in hole D1; drill panel, move plate to left putting in a slightly tapering plug through the hole D and in hole in panel just drilled, and drill again at D 1. Repeat this method until all holes are drilled—perfect in radius and spaced equal distances apart, and an easier way to do the job.

If an odd number of contact points are to be used, drill first hole on center line.

I have made several sets and had difficulty in drilling the holes true until I hit on this idea, and as there are so many amateurs "building their own," I thought they could get some good out of the idea.

—Contributed by U. B. Williams.

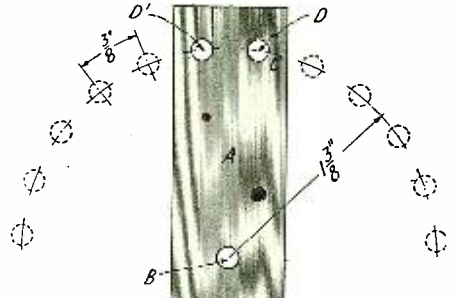

This Little Arrangement Saves Time and Money and Provides a Safety Factor that Guarantees the Drilling of True Holes.

**LIGHTNING-SWITCH INDICATOR**

Many of you amateurs have your lightning switch placed in such a position that it cannot be seen from the inside of the radio station. Sometimes it means a lot of running around to see what position it is in. An indicator is very desirable in such cases.

(Continued on page 1729)

# Correspondence From Readers

## A CORRECTION

Editor, RADIO NEWS:

Referring to the article which appeared in the January issue of RADIO NEWS, the circuit diagram is quite misleading. This shows the typical feed-back circuit tightly coupled, and the Kuhn circuit, whereas the label under it indicates that the ultra-audion circuit is shown.

I am enclosing the correct diagram. In this you will notice that the two electrodes at the terminals of the single oscillating circuit are the plate and grid. I have shown in the filament lead choke coils and a rejection circuit together with a wavemeter to illustrate the fact that these choke coils and rejection circuit may be placed in

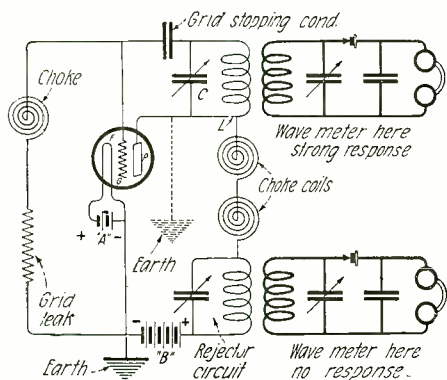

The "Ultra-Audion Circuit as Described by Dr. Lee de Forest in January RADIO NEWS.

this lead without in any way effecting the oscillations in the grid-plate oscillating circuit. A wavemeter so located gives absolutely no indication of oscillations, furthermore, as you pointed out in your article, the plate electrode can be grounded without effecting these oscillations.

This diagram and the above explanation should make very clear my contention that there exists a fundamental distinction between the ultra-audion circuit and the types of plate-filament plate-grid oscillating circuits which must always, in some way, be coupled together either inductively or through the audion bulb itself.

LEE DE FOREST.

## BROADCAST INTERFERENCE

Editor, RADIO NEWS:

On looking over your "Correspondence from Readers" column, I found very little being said on the subject of interference of the phone broadcasting station.

I have a very good receiving set (5 tubes) and can tune in most any station in the country, but, what good does this set do me when, after carefully tuning in the Chicago Opera along will come WCX or WOC or WDAB, etc., and interfere with the program.

By interfering I mean that their music, speech, etc., can be heard through the other one, which shows that the 400 meter stations are all exactly on 400 meters, and as they are all powerful stations (500 watt or more) it is quite impossible to get one in alone.

Now I would suggest that these 400 meter stations be put on a slightly different wavelength, just far enough apart not to cause a heterodyne whistle, this would at least give you a chance to get the better programs clearly.

The same method could be applied to the 360 meter class. By taking them in the different radio districts and assigning them various wave-lengths, and by allowing them to only broadcast two evening programs a week, which would also make room for more stations, and give them time to ar-

range better programs, instead of the mediocre programs now being broadcasted by some of the 360 meter class.

Now this can only be accomplished by concerted action on the part of the radio public. If each and every radio broadcast receiver will bring this matter before his congressman and senator, it will be but a short time before the pressure of public opinion will force Congress to act and make laws which will bring this greatest of inventions out of the chaos into which it is now being thrown.

If this plan is feasible (I have spoken to radio engineers and they said it is), the broadcasting stations and the radio Journals could help along for they have the opportunity to reach the greatest number of the radio public by continually urging them to write their respective senators and congressmen which would surely bring some action.

This to my mind, will at least be a step in the right direction of bringing some resemblance of order into the air.

FRED W. CATEL.  
Milwaukee, Wis.

## Some Interesting Articles Appearing In Practical Electrics for March

- New Theory of Magnetism.
- Electrical Pumps. By F. R. Kingman.
- Home Battery Charger.
- Three Brush Automobile Generator. By H. Highstone.
- Motor Without Visible Field.
- Planting Vines by Electricity.

## THE CAT IS OUT

Editor, RADIO NEWS:

In your January issue of RADIO NEWS, on page 1288, there is an article entitled "The Big Stick." In it you state that you cannot understand why the amateur was not represented at the meeting. Perhaps I can enlighten you. A notice was sent to us THE DAY AFTER THE MEETING TOOK PLACE. Nuf sed.

Sgt. R. C. WALKER, 5ZAK,  
San Antonio, Texas.

## A GOOD IDEA

Editor, RADIO NEWS:

Ask the fans what they think of the following: Every broadcasting station to have an automatic high-pitch buzzer or similar apparatus, which will send out the assigned call letters of the station during the periods of intermission, in the International code, thereby providing a satisfactory means of tuning to the desired station while it is "resting."

The main feature of this idea is the advantage of really knowing what station one is listening to. A person not knowing the code could easily refer to a code chart and determine the letters being transmitted, and incidentally automatically learn the code. There has been so much difficulty in making out the calls of stations announced by voice due to the similarity of certain letters.

I can always tell when I have picked up Havana, Cuba, by the "tick of a clock" which is evidently near the microphone. It would be well for the announcer to repeat the letters of his station, but if one did not

catch them he would have an unfailing announcer in the form telegraph.

MERRITT C. BARDEN,  
West Pawlet, Vt.

## WQM?

Editor, RADIO NEWS:

Attached please find copy of log of reception.

I would be glad if you would publish same with a view to putting me in touch with WQM.

COPY OF LOG  
27/11/22

G.M.T.

P.M.

11.48 WQM c/g WQL 215 meters C.W. Audibility 6 "WQL de WQM—Aerial current 1.2 amps. 1000 volts 45 milliamps—WQM"

11.52 "CQ de WQM—Hr 1.2 amp. in the aerial"

11.53 WQM on speech "Hello, etc." Speech audibility 4

11.56 WQM "va"

Receiver=1 Det-2AF

C. G. WILLIAMS (2JF),  
22 Scholer St.,  
Selton Park,  
Liverpool, Eng.

## A RADIO MYSTERY

Editor, RADIO NEWS:

Here is a phenomenon which looks as if it might be something Sir Conan Doyle is looking for, although the explanation, no doubt, will be very simple.

On the morning of November 24th, at about 12:20 A. M., I was playing at the now greatly popular game of "Radio Golf" and had made some pretty fair shots, when suddenly a very loud buzzing sound came into the phones, which made them an extremely uncomfortable piece of wearing apparel.

The sound was very similar to that produced by holding a piece of hard cardboard or stiff paper against the blades of an electric fan, or against the teeth of a fine gear wheel revolving swiftly. The note was constant in both volume and pitch.

My first move was to pull my phone plug out of the second step and plug it into the detector jack, in order to gain a little comfort, but the move was a failure as the second seemed to have just the same volume as before. I next tried tuning and I turned and twisted anything and everything, but it had just as much effect on that buzz as throwing a pail of water in the ocean.

Visions of short circuits began to float before me. I could see burned out bulbs, transformers, phones, together with the various "varios" with molten searing solder dripping down amongst them.

I frantically clutched the battery leads and in feverish haste disconnected every one of them, but to no avail, the demon noise still pursued me.

The nebula of an idea began to form—it grew—and at last, I thought the solution of the problem was at hand. I had been sitting up night after night into the "wee sma— hours" playing the absorbing scientific game, and the strain had been too great; it had undermined my nervous system to such an extent that something had to break—and this was it. Well, at any rate, my wife must be informed of my condition and I thought it would be better to break the sad news at once rather than have her notice my condition by some queer action on my part, such as answering a question with "dah-d-dah-dah-dt-d-d-d-d, etc." So I pulled out the phone plug and—yes! the sound was still there, but it had decreased to about half volume. I snatched the phones

(Continued on page 1743)



## Certificates Awarded To Date

- 1 Lowenstein Radiophone Corp., 397 Bridge Street, Brooklyn, N. Y., Type 5000 and 5001 Variable Condensers.
- 2 Fletcher Works, Sherwood and 2nd St., N. Penn Junction, Pa., Variometer.
- 4 Ala Manufacturing Company, 401 S. Sangamon St., Chicago, Ill., Chargometer.
- 6 Sunraid Radio Company, 534 Eighth Avenue, New York City, Rheostat.
- 7 National Airphone Corp., 16 Hudson St., New York City, National Airphone Set.
- 8 Allen-Bradley Company, Bradleystat.
- 9 Klosner Improved Apparatus Co., 2024 Boston Road, New York City, Improved Vernier Rheostat.
- 10 American Pattern Foundry & Machine Co., 82 Church St., New York City, King Rheostat.
- 11 I. R. Nelson Company, Bond St., Newark N. J., Improved Socket.
- 12 Chelsea Radio Company, 150 Fifth St., Chelsea, Mass., Variable Condenser No. 1.
- 13 Chelsea Radio Company, 150 Fifth St., Chelsea, Mass., Variable Condenser No. 3.
- 14 Chelsea Radio Company, 150 Fifth St., Chelsea, Mass., Socket.
- 17 Radio Guild, Inc., 256 West 34th St., New York City, Multirange Coupler.
- 18 Radiall Company, 99 Warren St., New York City, Amperite.
- 19 Newmann Stern Company, N. S. Building, Cleveland, Ohio, Teagle Socket.
- 20 Ship Owners Radio Service, 80 Washington Street, New York City, Framingham Rheostat.
- 21 New Haven Radio Company, 61 Hamilton St., New Haven, Conn., Marshall Condenser.
- 22 Radio Stores Corp., 218 West 34th St., New York City, Variable Condenser.
- 23 Chas. Freshman Company, Inc., 290 Hudson Street, New York City, Micon Condenser.
- 24 Precision Equipment Company, 2437 Gilbert Avenue, Cincinnati, O., Ace Tuner TRU.
- 25 F. Jos. Lamb Company, 264 E. Jefferson Avenue, Detroit, Mich., Lamb TW Tuner.
- 26 Newman Stern Company, N. S. Building, Cleveland, O., Teagle Rheostat.
- 27 Spies Electric Works, 562-564 W. Van Buren St., Chicago, Ill., Jack.
- 28 Radio Distributing Company, 8 W. Park Street, Newark, N. J., Variocoupler.
- 29 Martin-Copeland Company, 101 Sabin St., Providence, R. I., Hold-Tite Plug.
- 30 Stromberg-Carlson Tel. Co., Rochester, N. Y., Jacks.
- 31 Stromberg-Carlson Tel. Co., Rochester, N. Y., Plugs.
- 32 Ship Owners Radio Service Corp., 80 Washington St., New York City, Elite Variable Condenser.
- 33 Carlson & Johnson Machine Co., Wilkes-Barre, Pa., Variable Condenser.
- 34 J. C. Williams, 389-50th St., Oakland, Cal., Detector Stand.
- 35 Radio Stores Corp., 220 West 34th St., New York City, Torpedo Plug.
- 36 Radiall Company, 99 Warren St., New York City, L & K "Standard" Variometer.
- 37 Pioneer Radiophone Corp., 246 S. Seminary St., Galesburg, Ill., CWS Variometer.
- 38 Hinrichs Knoop Company, Peotone, Ill., Multipoint Switch.
- 39 Aiden-Napier Company, 51 Willow St., Springfield, Mass., De Lux Socket.
- 40 Supreme Electric Products Corp., 102 Main St., E., Rochester, N. Y., Balanced Variable Condenser.
- 41 H. H. Frost, 154 West Lake St., Chicago, Ill., Plug No. 137.
- 42 H. H. Frost, 154 West Lake St., Chicago, Ill., Plug No. 132.
- 43 H. H. Frost, 154 West Lake St., Chicago, Ill., Jacks.
- 44 Ship Owners Radio Service, Inc., 80 Washington St., New York City, Tunit.
- 45 G. H. Fisher & Co., 317 Cypress Hills Road, Glendale, L. I., Variocoupler.
- 46 Chelsea Radio Company, 150 Fifth St., Chelsea, Mass., Variable Condensers No. 3 and No. 4.
- 47 Chelsea Radio Company, 150 Fifth St., Chelsea, Mass., Variable Condensers No. 1 and No. 2.
- 48 I. R. Nelson Company, Bond St., Newark, N. J., Longwave Coupler.
- 49 Hammerlund Manufacturing Co., 114 West 18th St., New York City, Vernier Variable Condenser.
- 50 Sumter Radio Manufacturing Co., 103 S. Harvin St., Sumter, S. C., Variable Condenser.
- 51 A. B. Cole, Inc., 88 E. Kinney St., Newark, N. J., Variable Condensers.
- 52 Fletcher Works, Glenwood Ave. and 2d Street, N. Penn. Junction, Pa., Vernier Variometer.
- 53 Standard Variometer Co., City Point, Va., Gold Seal BC Variometer.
- 54 Cutler-Hammer Manufacturing Co., Milwaukee, Wis., Rheostat Plain—11,601-H1.
- 55 Cutler-Hammer Manufacturing Co., Milwaukee, Wis., Vernier Rheostat—11,601-H2.
- 56 Bethlehem Spark Plug Company, Variable Condenser CX 23, Bethlehem, Pa.
- 57 Klosner Improved Appliance Co., 2024 Boston Road, New York City, Model 200 Vernier Rheostat.
- 58 Carter Radio Company, 209 S. State St., Chicago, Ill., Hold-Tite Jack.
- 59 Carter Radio Company, 209 S. State St., Chicago, Ill., Tu-Way Plug.
- 60 Sumter Radio Manufacturing Co., Sumter, S. C., Rheostat.
- 61 Sumter Radio Manufacturing Co., Sumter, S. C., Potentiometer.
- 62 Precision Equipment Company, 2437 Gilbert Ave., Cincinnati, O., LC Lever Switch.
- 63 National Airphone Corp., 16 Hudson St., New York City, Gold Grain Detector.
- 64 Hartman Electric Manufacturing Co., Mansfield, O., Variable Condenser.
- 65 Mazda Radio Manufacturing Co., 1830-1840 E. 35th St., Cleveland, O., Rheostat.

## New Apparatus Awarded Certificates

### KLOSNER VERNIER RHEOSTAT.

Following the general trend toward controls, the Klosner Improved Apparatus Company, 2024 Boston Road, New York City, has placed on the market, its improved vernier rheostat, model 200. Both



the coarse adjustment and the vernier are controlled by a single knob. The control consists of a dial which can be engaged with the knob by simply pushing the knob in until the knurls on the outside of the dial and on the inside of the knob meet.

Thus the coarse adjusting arm may be moved to any position. The coarse adjustment is released when the pressure inward on the knob is released which permits the vernier adjustment to be made. A white mark on the knob indicates the position of the vernier arm. The entire instrument is well made, the base being of molded condensite and the resistance element wound on heat-resisting fibre. Two fibre washers are provided which are to be placed between the base and the panel to assist ventilation. The dial is graduated into 100 divisions for a rotation of 270 degrees. Tested for eight hours at 1.5 amperes. Arrived in excellent packing with instruction sheet and mounting screws enclosed.

AWARDED THE RADIO NEWS LABORATORIES CERTIFICATE OF MERIT, No. 57.

### SUMTER RHEOSTAT, TYPE 30-M.

Adequate heat-dissipating facilities are present in this 3 ohm rheostat made by the Sumter Radio Manufacturing Com-

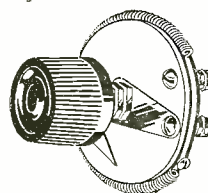

pany, 103 South Harvin Street, Sumter, South Carolina.

The resistance element of heavy gauge wire is wound into a spring and stretched over the periphery of the fibre base, resting securely in a groove. The german-sil-

ver contact blade is provided with a spring tension and runs smoothly and easily while making contact. This contact arm is prevented from working loose by the serrated nuts used in clamping it. The knob on the shaft is securely held by a set screw, the 1/4" shaft being knurled just where the set screw rests, thus effectively preventing any turning of the knob.

The rheostat is mounted by means of a bushing so that only one hole need be drilled in the panel. Two large washers are provided for locking in place on any size panel. The overall dimensions are 3" in diameter, 2 1/2" long with a 1 1/4" Radion knob. Arrived in excellent packing with instruction sheets enclosed.

AWARDED THE RADIO NEWS LABORATORIES CERTIFICATE OF MERIT No. 60.

**SUMTER POTENTIOMETER, TYPE HCT.**

Essentially, the same construction is used in this potentiometer as in the rheostat made by the Sumter Radio Manufacturing Company, 103 South Harvin Street, Sumter, South Carolina. Instead of a heavy resistance element, the potentiometer is wound with relatively fine resistance wire, the turns being separated from each other by means of a silk thread

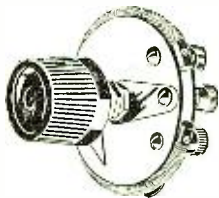

wound on at the same time. The resistance of the sample submitted was found to be 210.9 ohms. Three binding posts are provided, as usual for potentiometers. German-silver wire is used for the resistance element. Arrived in good packing with instruction sheets enclosed.

AWARDED THE RADIO NEWS LABORATORIES CERTIFICATE OF MERIT No. 61.

**ELITE VARIABLE CONDENSER No. 20**

The Elite Variable condenser was submitted for test by the Ship Owners Radio Service, Inc., 80 Washington Street, New York City.

Hard rubber is used in the construction of the end plates. Brass bushings serve as bearings for the 1/4" brass shaft, which is continuously rotatable. Aluminum plates are used for the conducting surfaces of the condenser. Capacity bridge measurements gave the following capacities: Maximum, 688.12 micromicrofarads, minimum, 24.9 micromicrofarads. The equivalent dielectric resistance was low, making the phase angle difference negligible. Arrived in good packing with no instruction sheet or mounting screws enclosed in the carton.

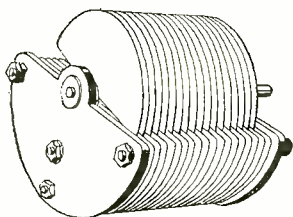

AWARDED THE RADIO NEWS LABORATORIES CERTIFICATE OF MERIT No. 32.

**ACME POT-RHEO**

To conserve space, the Acme Apparatus Company, 186 Massachusetts Avenue, Cambridge, Mass., offers its combined potentiometer and rheostat. Both units are

**A CORRECTION**

In the January issue of RADIO NEWS, on page 1299, were described some variable condensers made by the A. B. Cole Company, Inc., which were awarded the RADIO NEWS LABORATORIES CERTIFICATE No. 51. By mistake, these condensers were mentioned as being A. B. C. variable condensers. We regret this mistake which was caused by a similarity of initials, and we hereby notify our readers and all concerned that the condensers which were awarded Certificate No. 51 are the A. B. Cole variable condensers made by the A. B. Cole Company, Inc., 88 East Kinney Street, Newark, N. J.

mounted on a thermoplas base and are individually controlled by means of two concentric knobs. The rheostat consists of a spiral spring over a circular groove. Bridge measurements gave this unit a resistance of 3.58 ohms.

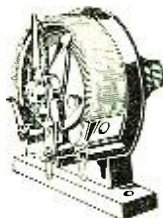

The potentiometer is wound with fine gauge enameled wire and has a resistance of 279.9 ohms. A metal dial is provided to indicate the position of the rheostat pointer.

Arrived in excellent packing with mounting screws and instruction sheets enclosed. AWARDED THE RADIO NEWS LABORATORIES CERTIFICATE OF MERIT No. 67.

**PIONEER TYPE CWS VARIO-COUPLER**

Moulded condensite forms are used to support the windings of this variocoupler made by the Pioneer Radiophone Corporation, 246 South Seminary Street, Galesburg, Illinois.

The primary is provided with 7 taps of 7 turns each and with 7 single turns taps. Connections to the rotor are made through the bearings and are under spring tension. The secondary is wound with 80 turns of D. S. C. wire. With a standard antenna of .00025 M.F., the primary responds to wave-lengths up to 625 meters. With a .00065 M.F. condenser across the terminals of the secondary, a wave-length range of from 260 to 960 meters may be obtained. Either panel or table mounting may be used, the web



feet for the latter purpose being moulded integral with the primary forms. The shaft takes a 3/16" bore dial.

Arrived in excellent packing. AWARDED THE RADIO NEWS LABORATORIES CERTIFICATE OF MERIT No. 68.

**RADIALL L & K "STANDARD" VARIOCOUPLER**

Following constructional lines similar to those embodied in their variometer, the Radiall Company, 99 Warren Street, New York City, are now offering their well-made variocoupler.

Both the primary and secondary are wound on hard rubber forms which are so

constructed as to allow the instrument to be entirely taken apart without injury to the windings. On the primary, eight taps are taken off at every eighth turn and eight taps taken off at every single turn. This winding uses No. 23 D. S. C. wire. The secondary which rotates inside of the primary has 40 turns of No. 22 D. S. C. wire which is spaced by means of a thread concentrically

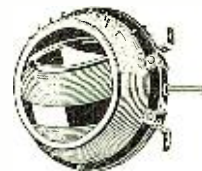

wound. With a standard antenna having a capacitance of .00025 M. F., the primary responds up to 650 meters. When the secondary is shunted by a .0005 M. F. variable condenser, the wave-length range is from 150 to 450 meters. Positive electrical contact is afforded by means of the extra long bearing system. The mean diameter of the primary is 3 3/4" and that of the secondary, 3 1/2". Since the shaft is 3/16" in diameter, a bushing is provided to allow the use of 1/4" bore dials. An additional bracket is provided to be attached to the rear of the variocoupler for added rigidity.

Received in excellent packing with instruction sheet and template enclosed.

AWARDED THE RADIO NEWS LABORATORIES CERTIFICATE OF MERIT NO. 69.

**MAZDA FILAMENT CONTROL RHEOSTAT**

Utilizing the resistance variation of a carbon pile under varying pressure, this filament control rheostat possesses unique features. It is made by the Mazda Radio Manufacturing Company, 1830-1840 E. 35th Street, Cleveland, Ohio.

A porcelain container encases the carbon pellets which are separated from each other by means of brass washers. Working through a specially shaped wire cam, the



maximum pressure on the pile is that exerted by a spring concealed in the porcelain casing. This prevents the possibility of crushing the resistance element. A hard rubber knob 1 5/16" in diameter is supplied for the control element. Tested for two hours at 2 1/2 amperes and for 15 minutes at 24 amperes. The latter test represents 69.6 watts being consumed in the resistance. No effect noticed except the expected generation of heat.

Arrived in excellent packing with template and instruction sheets enclosed.

AWARDED THE RADIO NEWS LABORATORIES CERTIFICATE OF MERIT NO. 70.

**JACOBUS TYPE "JSW" LIGHTNING ARRESTER.**

This lightning arrester of the vacuum gap type is manufactured by the Apex Elec-

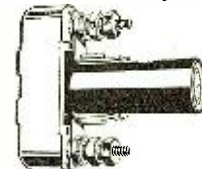

tric Specialty Company, 77 Orange Street, Newark, New Jersey.

It has been passed by the Underwriters Laboratories. An evacuated glass container (Continued on page 1741)

# Radio Humor

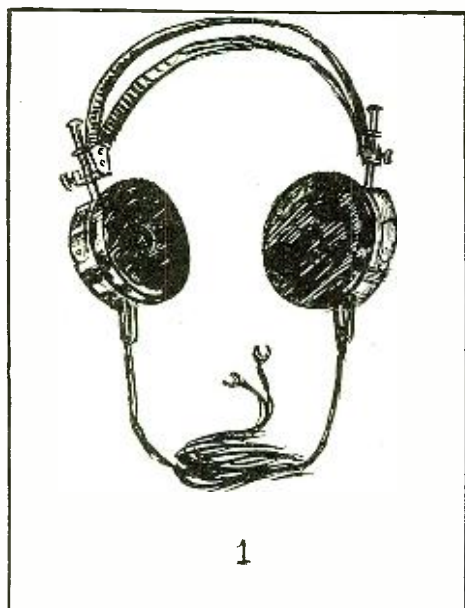

1

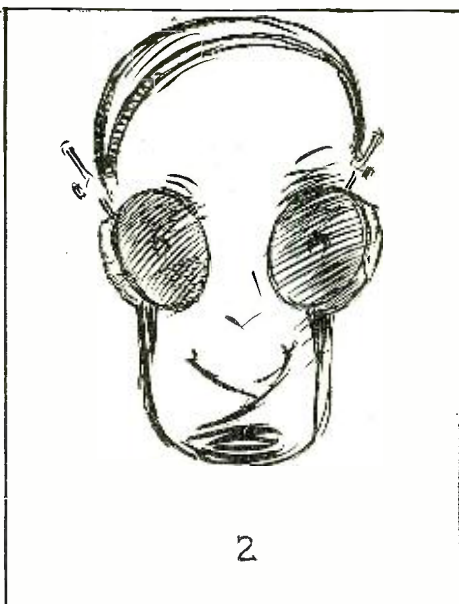

2



3



Great Stuff

What a Radio Fan Is Made Of

## I Gotta Know

**Q**UERIES of the radio insects will be answered in this column by our own staff of highly trained Hartz Mountain rollers. Readers desiring information for use in the current year should enclose ten cents for answer by mail. Or, three different answers to same question for a quarter. Write only on the outside of the paper. We do not accept renovated stamps.

### COMMON ERROR

Mr. P. Fish, Rustling Palms, Alaska, says:

**Q. 1.** Following the directions in your issue of February, 1889, I wound my tuner on a Quaker Oats Corn Meal carton, but I hear only a fluttering noise when it is connected.

**A. 1.** You are hearing what is known as "mush". Rewind on a table-salt box, and everything will come in clear as crystal.

### ASK US

Mr. D. F. Hamm, Cor-sur l'Andouillette, Kansas, inquires:

**Q. 1.** I have read in your columns of

using a transformer instead of batteries. There is a transformer on the electric light pole back of our house. If I connected my set to this would it carry farther?

**A. 1.** Fine dust from the eruption of Mount Krakatoa fell 3000 miles at sea.

### INEXPENSIVE OUTFIT

Mr. Aloysius Sissenschwishter, Mulberry Bend, N. Y. C., asks:

**Q. 1.** I want to make an eight-tube receiving set, but have no money to buy any of the parts. How can I secure them?

**A. 1.** Inquire at Registry Dept., N. Y. C. Post Office.

**A. 2.** Study prestidigitation.

**A. 3.** Sing once like Martinelli. He gets \$300 a performance, we are told. This amount would give you a good start toward the set you mention.

### HANDY PORTABLE SET

Mr. Kokopopolos Hennigan, Wallowallow, Wash., requests information:

**Q. 1.** I have a large collection of switch points, four R. F. transformers, Arlington loose coupler, UV 45 cal. tube, microphone, motor-generator, antenna towers, dials and a tin roof. I want to make these into one of those handy sets I see in the papers—the kind people carry in their hats and hear POZ with.

**A. 1.** At the second-hand dealer's, purchase for little or nothing a used freight car. Almost any amateur has a few bakelite panels about six feet or eight feet square lying around among his junk. Mount these in the side of the car, and there you are.

### SENSITIVE EARS

Mr. Salomon McGregor, Boulevard de l'Imperatrice, Dudds, Okla., asks:

**Q. 1.** What do you think of a crystal set guaranteed to bring in the music 100 miles clear as a bell?

**A. 1.** Some bell.

### IT'S A GIFT

Mr. P. U. M. P. Bland-Blandly, Farthest North, U. K., would like to know:

**Q. 1.** I became interested in radio last week and am constructing my first set. I intend to employ the new Armstrong super-circuit, making all parts myself. What results may I expect?

**A. 1.** We know, but we can't exactly put in into words.

### SIMPLEST HOOK-UP

Mr. Hans Ramequin, Ocean Grove, Nevada, writes:

**Q. 1.** Please show simplest hook-up.

**A. 1.** The circuit you ask is shown below. In this arrangement, the mental reactance is reduced to a negative. Before mounting in a cabinet, it would be well to lay it out on a board like a planked fish.

Input \_\_\_\_\_ Output

### Getting Out "Radio News"

Getting out a magazine is no joke. If we print jokes, folks say we are silly. If we don't they say we are too serious. If we publish original matter, they say we lack variety. If we publish things from other papers, we are too lazy to write. If we stay on the job, we ought to be out rustling news. If we are rustling news, we are not attending to business. If we don't print contributions, we don't show proper appreciation.

(Continued on page 1713)

### USE LAST SUMMER'S

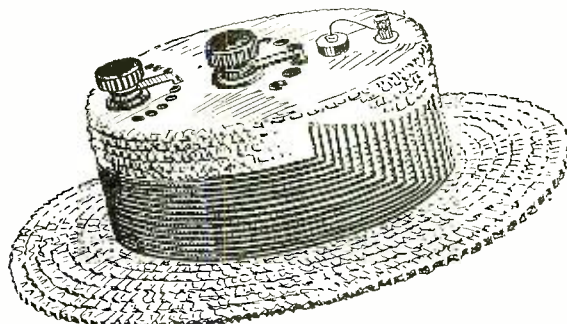

WHY NOT ?



**SIGNAL RECEIVING SYSTEM**

(No. 1,430,883, issued to Burke Bradbury, Schenectady, N. Y., October 3, 1922)

This invention relates to signal receiving systems and more particularly to signalling systems employing continuous radio frequency currents. The object of this invention is to provide a simple and efficient means for producing an audible indication of signals transmitted by means of radio frequency continuous currents. The source of audio frequency currents is provided at a receiving station which is associated with

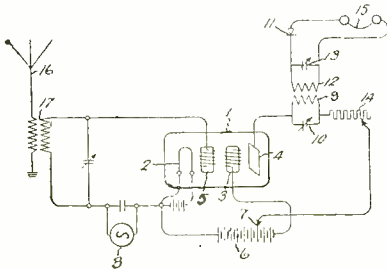

the electron-discharge device and a detector in such a way that when no signalling currents are impressed upon the system, there will be no appreciable flow of audio frequency currents in a detector circuit. When, however, a radio frequency signalling current is modulated by means of the audio frequency source and the modulated radio frequency signalling current is transmitted to the detector circuit where it is rectified and the rectified current is used to produce the desired audible indications. When no signals are being received, no appreciable amount of audio frequency will be produced in the detector circuit and in the telephone receivers because of the fact that the detector circuit and the circuit with which it is associated are both tuned to the radio frequency of the signal and the coupling between 9 and 12 is too loose to permit the transfer of any appreciable amount of audio frequency current. When signals are received on the antenna, 16, and impressed upon the circuit between cathode and discharge-controlling grid by means of the coupling transformer, 17, the potential of the grid, 5, will vary at a radio frequency corresponding to the frequency of the signalling current, this radio frequency being modulated in accordance with the audio frequency source, B. A modulated current of radio frequency will then be produced in the circuit, 9-10, and this modulated radio frequency current will be transferred to the detector circuit by means of the coupling, 9-12, and when rectified in that circuit by the action of the detector, 11, will produce an audio frequency current in the telephone receivers, 15.

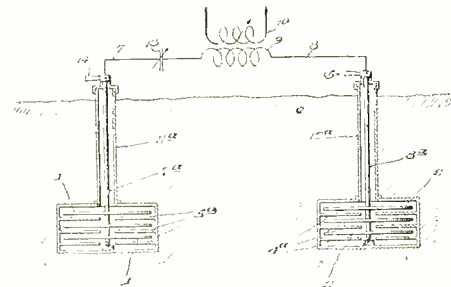

**RADIOSIGNALLING SYSTEM.**

(No. 1,429,240 issued to E. C. Hanson of Washington, D. C., and E. T. Jones of New Orleans, September 19, 1922)

This invention pertains to a radio transmission and reception system comprising an antenna including a plurality of sets of capacity areas buried below the surface of the earth, means for varying their mutual capacity with the earth and a circuit associated with radiosignalling apparatus and connected with said sets of capacity areas. Experiments have determined that antenna construction similar to this disclosed herein possess features of distinct advantage over the underground systems heretofore employed. The concentrated capacity area gives the same effective antenna surface as long buried single wire conductors. It has also been found that placing the capacity antenna areas a distance of approximately 50 feet apart, radio signals have been received from considerable distances and at high audibility.

**ACOUSTICAL AID FOR DEAF PERSONS**

(No. 1,422,877, issued to Joseph P. Maxfield of Maplewood, N. J., July 18, 1922)

This invention makes use of a form of microphone which while fairly sensitive to small sounds, is not proportionately more sensitive to sounds of greater magnitude so that sudden shocks and jars do not produce excessively loud sounds in the telephone receiver. This microphone is used in conjunction with a distortionless amplifier, preferably of the audion type. This outfit is made adjustable to give any desired volume of sound depending on the sensitiveness of the ear, the intensity of the sound and the prevalence of disturbing noises. Preferably two of these microphone-amplifier systems are employed, each leading to a separate telephone receiver. The microphones are located from 10 to 14 inches apart with their diaphragms in approximately the same plane. One receiver is worn on each ear, the right-hand receiver being connected to the right-hand microphone amplifier and the left-hand receiver being connected to the left-hand microphone amplifier. The use of a binaural system of this sort is found to be remarkably efficient in enabling the user to focus his attention on the particular sound which he desires to hear, for by orienting the dual microphone set so that the microphones lie in a plane at right angles to the source of sound, the same ability to concentrate is noticed as when a person of normal hearing turns to face the speaker.

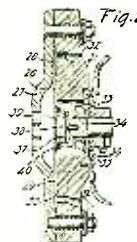
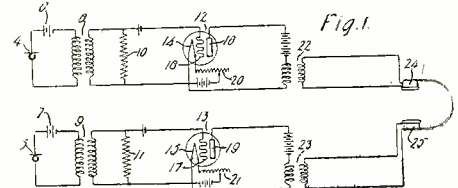

**RADIO RECEIVING SYSTEM HAVING HIGH SELECTIVITY.**

(No. 1,416,061 issued to Michael A. Pupin and Edwin H. Armstrong of New York City, May 16, 1922)

The object of this invention is to provide for radio transmission purposes, a receiving system of extremely high selectivity. It is here proposed to deal with the low or audio frequency current variations or pulsations in the receiving system; it being understood that the arrangement of the present invention may be used in conjunction with, and as a supplement to, unknown or subsequently discovered selectivity-increasing means applicable to the high or radio frequency oscillations in such systems. Primarily, the purpose of the present invention is attained by developing a receiving system in which the current variations or pulsations in the detector circuit are reduced to a very low frequency for the purpose of separating them from a disturbing influence (including natural atmospheric disturbances as well as artificial disturbances originating at the sending stations of other systems) and subsequently multiplied in frequency to bring them well within the range of audibility.

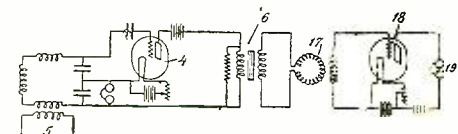

**RADIO TRANSMISSION**

(No. 1,422,882, issued to Harold W. Nichols of Maplewood, N. J., July 18, 1922)

This invention relates to the art of transmit-

ting signals by means of high-frequency electrical waves.

Its object is to vary or modulate the amplitude of radiated high-frequency waves in accordance with the wave form of signals to be transmitted. Its object is also to accomplish this modulation without requiring that the telephone transmitter, telegraph key or other primary source of modulated power shall handle all the power required to be modulated.

A further object of this invention is to modulate the radiated power in an efficient manner by

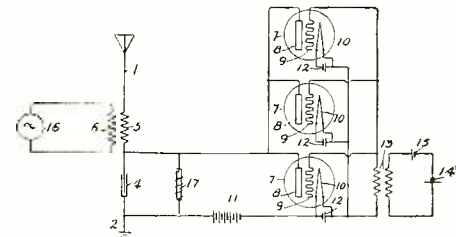

correct proportioning of the impedances of the system.

These objects are accomplished by making use of the fact that in a thermionic amplifier of the audion type, the impedance of the output circuit depends upon and varies with the voltage impressed upon the input circuit, and that the changes in power output, due to such changes in impedance, are much larger than the power input required to produce them. On account of this property, it is obvious that if the antenna current is made to flow through the output circuit of an amplifier, large variations in the power radiated from the antenna can be produced without using excessive power in the primary modulating source, and therefore permitting the use of a commercial telephone transmitter, or telegraph key as this primary source.

In order that the output circuit of the amplifier may be supplied with current, it is necessary to shunt the condenser with the choke coil, 17. The impedance of this choke coil to high frequency currents is so large that practically none of the antenna current passes through it, while at the same time, it offers unobstructed passage to the output circuit of the amplifier circuit. This choke coil also serves another purpose in that it allows the discharge of accumulated electricity on the antenna, such accumulated charges being otherwise prevented from flowing to the ground by the condenser, 4.

**CONSTANT-RESISTANCE ELECTRON-DISCHARGE DEVICE**

(No. 1,430,607, issued to William C. White of Schenectady, N. Y., October 3, 1922)

The present invention relates to an electron-

Fig. 1.

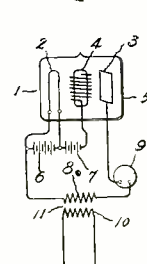
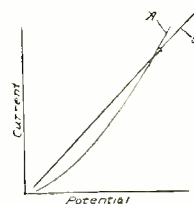

Fig. 2.



discharge device and has particular reference to the resistance characteristics of such devices. It has been discovered that the current which will flow through an electron-discharge device comprising an incandescent cathode and anode enclosed in a highly evacuated envelope will, between certain limits, vary approximately as the 3/2 power of the applied voltage. In other words, the apparent resistance of such a device varies with the voltage applied to it. The object of this invention is to overcome this disadvantage by constructing and arranging an electron-discharge device in such a way that the current therethrough will vary directly as the applied voltage between certain well-defined limits. As indicated in Fig. 1, an electron-discharge device, 1, comprises the cathode, 2, and anode, 3, and a grid-shaped electrode, 4, enclosed in a highly evacuated envelope, 5. The cathode, 2, is provided with the usual bat-

(Continued on page 1732)



## An Experience

By EDWIN H. GLAUSE

ALMOST every young man who decides to "go down to sea in a ship" as a radio operator, experiences, before many months have been served, one or more difficulties either in the dispatching of traffic apparatus break-downs, or embarrassing situations that at the moment of occurrence have a tendency to be rather trying on his nerves. Possibly before the trouble has been removed or the perplexing circumstances forgotten more than a few honest drops of sweat have trickled from the operator's brow. It is after moments such as these and the trouble has been adjusted with everything again running smoothly that one feels like stretching himself and with a sigh of relief exclaiming, "Oh, ain't it a grand an' glorious feeling?"

It happened that in one instance, some time back, while assigned to a passenger vessel, I was placed in a somewhat embarrassing predicament. This by the way was my initial trip and so those of you who have worked commercial radio will understand that my general comfort could hardly be compared to that of an old-timer who calmly sits back in his chair, lights his pipe, providing no one's around, and dispatches his traffic with ease.

A short time before going aboard, I had risked bankruptcy by investing in a watch of the famous one dollar variety, thinking it would be a handy article in con-

junction with a good alarm clock, the latter to be substituted in place of the chow-hammer which prevails on cargo vessels for the same purpose. My folks had seen to it that I carried nothing so elaborate as a gold watch, and I would not, if I followed their advice, until I reached my majority. Such a thing seemed to them as too easy a living that might tempt one of those persons with whom strictly personal relations with the police do not exist.

As is generally always the case, all the obstacles I had anticipated encountering failed to materialize and the ultimate result was that everything went off smoothly, the first day. I was really beginning to take on the aspect and manner of a thoroughly seasoned operator. Also, the watch was apparently giving satisfactory service, and as was the custom, I checked her with the time signals that evening.

Next day one of the passengers dropped around and after the usual conversation of how wonderful wireless was and relating the old, old, story of dropping a pebble in a pond and going over everything from the antenna insulators to the ground plate, he finally told me of himself, introduced himself as Mr. Brown who had a controlling interest in a large mining industry; this he did not reveal, but I gathered from his talk that he was taking a brief vacation. The conversation drifted and he looked at his

watch in a business-like way and remarked about its being time for dinner and at the same time asking me the correct time, which I gave him, having just previously explained to him how exact time was received by radio. His watch was off some 20 minutes which was curious indeed, for he had just recently purchased it; nevertheless, he smiled, bade me good evening and withdrew.

A few hours later the skipper called down the tube for the correct time which was promptly given him.

The next morning I found myself late for breakfast, I was over an hour late, although according to my watch I was on time. From that time on I relied no more on said watch. It is now laying in a good many feet of water presumably at rest. I never heard a word from the old man, but it was not a puzzling matter to me just why he never again inquired the time from me as long as I was on his vessel.

And there was some rumor among the porters concerning a certain middle-aged gentleman who was late to dinner having expressed himself rather strongly to the head waiter in the dining room when told of the fact. I wonder if he still regards time by wireless a success? Something tells me he doubts it.

Anyhow, it was my first real experience and I took sufficient pains to see that it was never repeated.

## New Schedules of Weather Reports Broadcast from NAT

Beginning January 1, 1923, weather forecasts and warnings for each of the States comprising the New Orleans forecast district, river forecasts, and a summary of weather conditions over the United States (NAT) at New Orleans, La.

The weather forecasts issued from New Orleans are for Louisiana, Arkansas, Oklahoma, eastern Texas (east of the 100th meridian), and western Texas (west of the 100th meridian). The forecasts for Louisiana and east Texas include, respectively, winds along the Louisiana and Texas coasts. Forecasts of stages on the Ouachita and on the lower Red and Mississippi Rivers will be broadcast only at 10:30 a.m.

The localized bulletins for the special benefit of marine interests, which have been broadcast from this radio station since June 10, 1921, as described in Weather Bureau Circular dated May 28, 1921, will be continued as heretofore.

The complete schedule (75th meridian time) is as follows:

Wave-length, 1,832 meters. spark.

10:30 a.m., State forecasts, river forecasts, and weather summary.

11:00 a.m., localized bulletin for marine interests.

5:00 p.m., storm, hurricane, frost, and cold wave warnings issued in afternoon.

10:00 p.m., State forecasts and weather summary.

Hurricane warnings and advisory messages relating thereto will be broadcast whenever issued and continued at 2-hour intervals until midnight.

### MEXICO GIVES MARINERS RADIO AID

The Mexican Government inaugurated a new broadcasting service for mariners on November 1. The service comprises the picking up and re-broadcasting of notices to mariners emanating from radio stations in America and Cuba, and vessels within their zone, by six Mexican stations on both the Pacific and Gulf Coasts.

### SHIPPING BOARD INAUGURATES OCEAN LETTER SERVICE

Vice-President Jos. E. Sheedy, United States Shipping Board Emergency Fleet Corporation, announced today the inaugurating of an ocean letter service aboard Shipping Board vessels for the convenience of those who travel on them and have need of a reasonable quick service for handling their correspondence at a low rate.

The service provides facilities whereby messages from a ship bound in one direction are transmitted by radio to a ship bound in the opposite direction. The receiving ship mails the ocean letter upon arrival in port.

The rate for this service is \$1.20 for twenty words including registration and postage with 4 cents for each additional word. The messages are limited to a maximum of one hundred words.

By using this service, any person aboard Shipping Board vessels can mail a letter at a minimum cost and expedite its delivery appreciably to any addressee.

### TROPICAL RADIO COMPANY GETS MIAMI NAVAL STATION

The lease of the Naval Radio Station at Miami Beach, Florida, was awarded to the Tropical Radio Company of Boston, Mass., the highest bidder in the recent call for bids. This company, which is connected with the United Fruit Company, offered to take the station for 18 months at an annual rental of \$3,600 with permission to extend the lease an additional year. The Radio Corporation of America, and Cutting & Washington of New York, also filed bids.

According to the terms of the lease, the Tropical Radio Company must replace the old rotary spark set with modern equipment which will reduce the objectionable noise to a minimum.

With the enactment of necessary legislation, it is understood that the Navy will ultimately offer the station for sale.





**T**HIS Department is conducted for the benefit of our Radio Experimenter. We shall be glad to answer here questions for the benefit of all, but we can publish only such matter as is of sufficient interest to all.

1. This Department cannot answer more than three questions for each correspondent.
2. Only one side of the sheet should be written upon; all matter should be typewritten or else written in ink. No attention paid to penciled matter.
3. Sketches, diagrams, etc., must be on separate sheets. This Department does not answer questions by mail free of charge.
4. Our Editors will be glad to answer any letter, at the rate of 25c for each question. If, however, questions entail considerable research work, intricate calculations, patent research, etc., a special charge will be made. Before we answer such questions, correspondents will be informed as to the price charge. You will do the Editor a personal favor if you will make your letter as brief as possible.

**R. F. TRANSFORMER WAVE-LENGTHS.**

(614) Mr. E. A. Bertinet, of Rockville Center, L. I., asks:

Q. 1. Please give a diagram of a honey comb set using one stage of R. F. and two stage of A. F. amplification.

A. 1. This hook-up will be found in these columns.

Q. 2. Would a "C" battery be an advantage?

A. 2. A "C" battery will sometimes give better results and is connected in the grid circuit of the amplifying tubes, with the negative terminal leading to the grid. The voltage will vary from 1 1/2 to 7 volts. A little experimenting will be necessary to obtain the proper value.

Q. 3. Is a separate R. F. transformer necessary for different wave-lengths?

A. 3. R. F. transformers only cover a very small band of wave-lengths on the lower waves. A transformer will only work efficiently from about 180 to 300 meters, if designed for 200 meters work. If 360 meter reception is desired a different transformer will be used. This transformer will cover a band of wave-length from 300 to about 600 meters. The higher the wave-length the broader the efficient wave-length band will become.

**SIMPLE TUBE CIRCUIT.**

(615) Mr. Nathan E. Thompson, Porter, Minn., asks:

Q. 1. Please publish a hook-up using one variable condenser, one variometer and one tube.

A. 1. This circuit appears on these pages.

**FILAMENT CONTROL JACKS.**

(616) Mr. James Mazzone, Jr., St. Louis, Mo., wants—

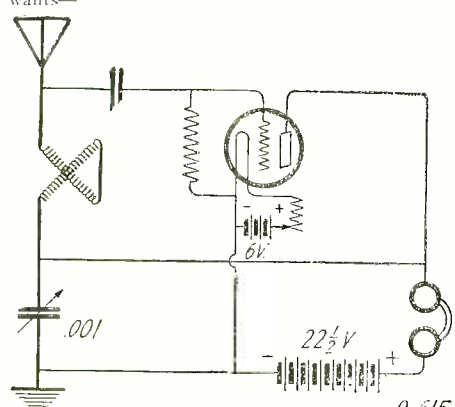

Q 615  
The Ultra-Audion Circuit Comprising a Variable Condenser and a Variometer for Tuning.

Q. 1. A hook-up of a standard short wave regenerative receiver, with two steps of audio-frequency amplification, using filament control jacks.

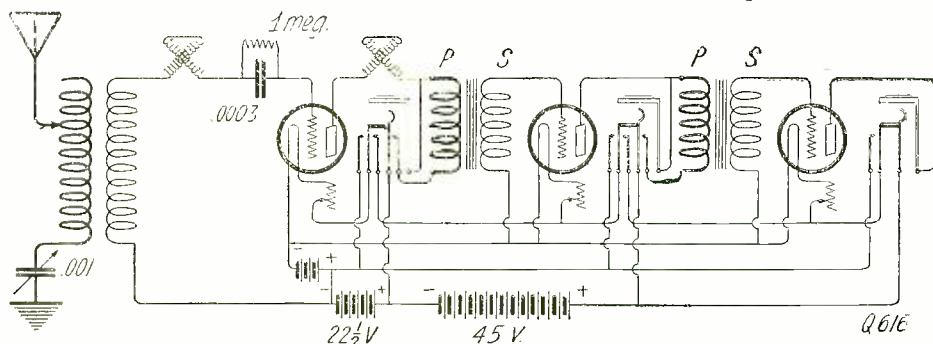

Q 616  
A Standard Three Circuit Regenerative Receiver and Two Stages of Audio Frequency Amplification Using Filament Control Jacks. This Type is Very Suitable for Average Work.

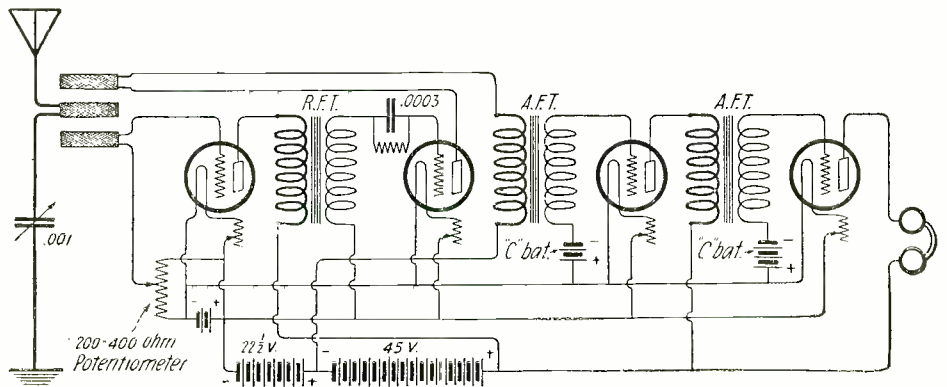

Three Coil Honeycomb Receiver With One Stage of Radio and Two Stages of Audio Frequency Amplification, Employing the Usual Tickler Feed Back.

A. 1. This hook-up is shown herewith.

Q. 2. Can a 30-volt storage "B" battery be connected in series with a 45-volt dry "B" battery?

A. 2. Yes, this can be done, but make sure that the dry battery is not left in the circuit after it has run down.

**REFLEX CIRCUIT.**

(617) Mr. Theo. H. Peterson, Richmond Hill, N. Y., asks:

Q. 1. Please publish the reflex hook-up using three tubes for two steps of radio, detector and two steps of audio frequency.

A. 1. This circuit will be found in the February issue, question 611.

**REINARTZ TUNER.**

(618) Mr. Frank Molycka, 324 E. 73d street, New York City, requests:

Q. 1. Kindly give a hook-up of the Reinartz Circuit.

A. 1. This hook-up appears on these pages.

Q. 2. Give all data which would aid me in constructing same.

A. 2. The diagram is self-explanatory. The tuner can consist of a variocoupler with the rotor connected in series with the beginning of the primary winding.

**CONDENSER IN HONEY COMB CIRCUIT.**

(619) Mr. Robert D. Little, Tuscaloosa, Ala., wants to know—

Q. 1. Which should be used in primary circuit using honey comb coils, .0015 mfd. or .001 mfd.?

A. 1. Either condenser will give good results. The .0015 mfd. condenser will enable you to tune to a higher wave-length.

Q. 2. What type aerial should be used with honey comb coils?

A. 2. No particular type is needed. An antenna with an over-all length of 125 feet will

prove very good. Only one wire is best for reception.

Q. 3. Should the tickler coil be shorted for spark reception?

A. 3. No. The tickler is used, otherwise regeneration could not be had.

**A. F. AMPLIFICATION WITH MULTI-RANGE RECEIVER.**

(620) Mr. G. E. Lynch, Knoxville, Tenn., asks:

Q. 1. Please show an efficient hook-up for a two step amplifier, to be used with the Multi-Range receiver.

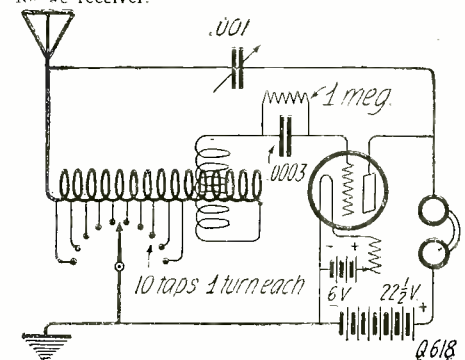

Q 618  
The Improved Reinartz Circuit. The Variocoupler is Connected as a Variometer. Regeneration is Controlled by the Variable Condenser.

A. 1. This hook-up will be found on these pages.

**A. B. & C. BATTERIES.**

(621) Mr. Orville Jack, McArthur, Calif., wants to know:

Q. 1. What is the difference between "A," "B," and "C" Batteries?

A. 1. An "A" Battery is the battery used to light the filaments of the tubes, the "B" is the battery that supplies the voltage for the plate, and the "C" battery is used in the grid circuit of amplifying tubes to provide the correct negative charge on the grid.

Q. 2. Is it possible for a battery to have volts and no amperes?

A. 2. No. If a battery has voltage, it must have amperage to some degree. In the case of a Tesla coil, for instance, the voltage may run into millions, and the amperage would be almost unmeasurable, but it would be there just the same.

Q. 3. What is the difference in construction of a fixed condenser, a phone condenser, a grid condenser and a grid leak?

A. 3. There is no mechanical difference in these condensers and they are all fixed condensers. The only difference lies in the capacity of each

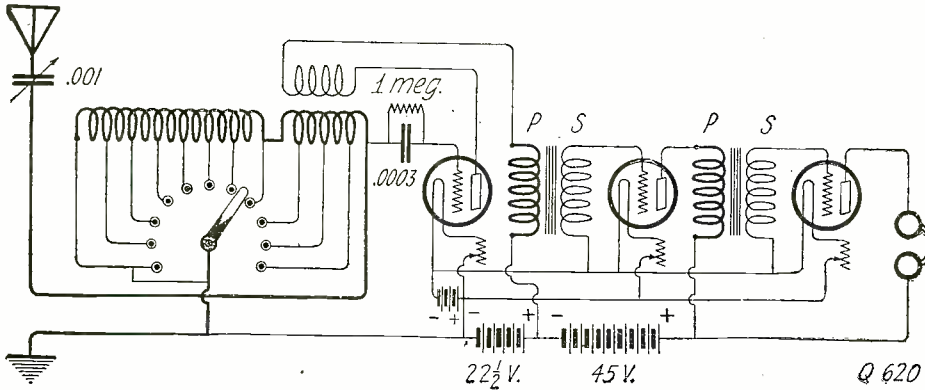

A Multi-Range Coupler Employed with a Two Stage Audio Frequency Amplifier. The Rotor of the Coupler Functions as the Tickler in this Circuit.

condenser. A phone condenser has a capacity of about .002 mfd. and a grid condenser about .0003 mfd. A grid leak is a high resistance shunted across the grid condenser and will vary from 1/2 to 2 megohms.

**CRYSTAL HOOK-UP.**

(622) Mr. Edward W. Schoenfeld, Brooklyn, N. Y., wants to know:

Q. 1. How to improve the selectivity of a crystal set.

A. 1. We are showing a circuit, in which a separate coil is used as a resonance coil. This will prove of benefit in tuning out undesired signals.

**EFFICIENT SHORT-WAVE RECEIVER.**

(623) Mr. J. H. Whelan, St. Paul, Kans., wants to know:

Q. 1. A circuit diagram of what is considered the most efficient and sharpest tuning receiver.

A. 1. This hook-up will be found in the January issue, Question 583. The efficiency of this set largely depends upon the skill of the operator. Correctly tuned this set is hard to beat.

Q. 2. Would W. E. power tubes be more efficient in a three-stage amplifier than ordinary amplifying tubes?

A. 2. Yes. If higher voltage were used on the plates.

Q. 3. What Ratio transformer is best?

A. 3. For first two stages a ratio of 5 to 1. For last stage a 3 to 1 ratio is used.

**SUPER-HETERODYNE.**

(624) Mr. H. G. Ulmer, Cleveland, Ohio, wants to know:

Q. 1. What receiver is the best between the super-heterodyne and the super-regenerative?

A. 1. The super-regenerative will give the greater volume of sound for a given number of tubes for a short distance, but the super-heterodyne is superior for selectiveness, distance receiving and all-round efficiency.

Q. 2. Please give the hook-up of the super-heterodyne.

A. 2. This hook-up will be found on these pages. All data will be found on the diagram.

**MULTI-RANGE TUNER.**

(625) Mr. Ralph Tardy, Helena, Ark., requests:

Q. 1. Please publish a hook-up of the multi range tuner with two stages of A. F. frequency.

A. 1. This hook-up will be found under question No. 620.

Q. 2. What size aerial should be used?

A. 2. The aerial should be a single wire about 100 to 125 feet long for best reception.

Q. 3. Is it advisable to construct a set of this kind?

A. 3. If you want a great increase in sound volume, this is the way to get it. Very good results can be had with this set.

**INTERFERENCE ON CRYSTAL SET.**

(626) Mr. Walter Grohe, Bronx, New York City, writes:

Q. 1. How can I make my crystal set more selective?

A. 1. This was answered in question No. 622.

Q. 2. Can a crystal set be made regenerative?

A. 2. A crystal receiver cannot be made regenerative.

Q. 3. What is a tickler?

A. 3. A tickler is a coil in the plate circuit of a vacuum tube and is in inductive relation to the tuner, so as to feed the induced energy back to the grid circuit.

**RECEIVING RANGE.**

(627) Mr. John S. Wiebe, Canada, wants to know:

Q. 1. What would be the maximum distance which messages could be received, using the set described on page 860 of the November issue of Radio News?

A. 1. This all depends upon the power of the transmitting station, kind of detector used, local conditions, etc. However, no trouble should be

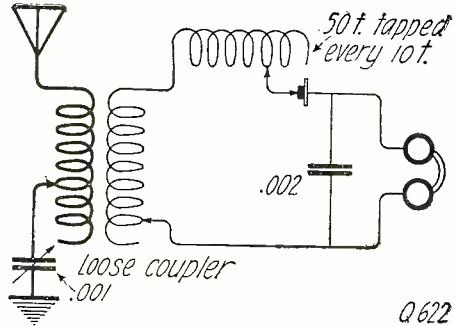

A Crystal Receiver is Made More Selective by the Insertion of a Second Variable Inductance in the Secondary Circuit.

had receiving at least 500 miles under favorable conditions.

Q. 2. On what does the capacity of receiving depend?

A. 2. This depends largely upon the skill of the operator. The circuit used and the quality of the instruments, and workmanship on the set, also figures very largely. The geographical location is also a factor to be considered.

Q. 3. Do you think it would be worth while to make this set?

A. 3. This is a question we cannot answer. Very good results are obtained if this set is carefully made, and this all depends upon the builder.

**STORAGE BATTERY CONSTRUCTION.**

(628) Mr. Glenn Meyer, Los Angeles, Calif., says:

Q. 1. What is the electrolyte composed of in the storage "B" battery described on page 871 of the November issue?

A. 1. This is a 10 percent solution of sulphuric acid and distilled water.

Q. 2. How many cells for a 22 1/2-volt battery?

A. 2. Each cell gives 2 volts. Eleven cells will give 22 volts.

Q. 3. What is the object shown between the two plates?

A. 3. This is the separator, consisting of a piece of hard wood and is designed to keep the plates apart.

**HOOK-UP FOR W. D. 11.**

(629) Mr. Randall Cullin, Detroit, Mich., wants to know:

Q. 1. The most efficient hook-up using the W. D. 11 tube.

A. 1. There seems to be a misunderstanding concerning the W. D. 11 tube. This tube will work efficiently in any detector circuit and no special apparatus is needed. We are publishing an article on this subject in this issue.

**HONEY COMB COILS IN A "SUPER."**

(630) Mr. F. C. Carter, Jr., Wichita Falls, Texas, inquires:

Q. 1. Would it be practical to use honey comb coils in place of a vario-coupler in a super-regenerative circuit?

A. 1. Good results should be obtained by substituting honey comb coils for the vario coupler. The tickler would preferably be 75 turns and the primary can have 50 turns or less, and shunted by a variable condenser.

Q. 2. Will a three-tube "super" bring in stations louder than a detector and two-step, the "super" using a loop and the standard set using an outside antenna?

A. 2. If the distance to be covered is not more than 30 or 50 miles the super-regenerative set will give the greater volume of sound. At greater distances than this the "super" does not seem to give such good results.

**BALDWIN PHONES.**

(631) Mr. B. H. Reddy, Long Beach, Calif., wants to know:

Q. 1. Where and by whom are Baldwin phones made?

A. 1. These phones are made by Nathaniel Baldwin, Salt Lake City, Utah. These phones are still being manufactured.

Q. 2. Is there any advantage or disadvantage in a 180 degree vario-coupler?

A. 2. The only advantage in this type of coupler is that a finer degree of coupling can be obtained. The rotor is set at such an angle, in regard to the primary, that for every two degrees turned on the dial, the rotor only moves one degree. This acts after a fashion as a vernier adjustment of the coupling.

Q. 3. Please give composition of fuseable metal used for mounting crystals.

A. 3. A simple method is to dissolve as much tin foil in mercury that is possible. When the mercury will dissolve no more tin foil it is heated over a flame until it is melted together. Upon cooling, it will melt in hot water. Another formula is to melt together two parts of pure tin, four parts of lead and eight parts of bismuth. This metal will melt at 151 degrees.

**RHEOSTAT FOR W. D. 11 TUBE.**

(632) Mr. Geo. B. Williams, Wetumka, Okla., asks:

Q. 1. Does a W. D. 11 Tube require a special rheostat or will any standard one do?

A. 1. No special rheostat is required with this tube.

Q. 2. Will any standard A. F. Transformer work with this tube?

A. 2. Yes, any good A. F. transformer will be satisfactory

(Continued on page 1713)

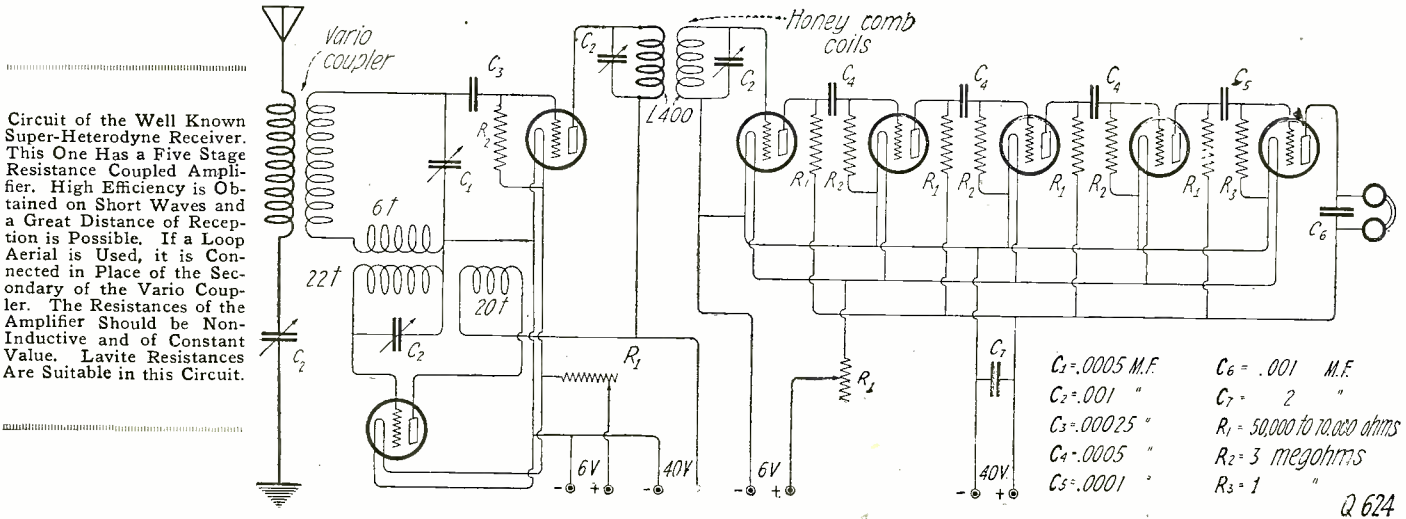

Circuit of the Well Known Super-Heterodyne Receiver. This One Has a Five Stage Resistance Coupled Amplifier. High Efficiency is Obtained on Short Waves and a Great Distance of Reception is Possible. If a Loop Aerial is Used, it is Connected in Place of the Secondary of the Vario Coupler. The Resistances of the Amplifier Should be Non-Inductive and of Constant Value. Lavite Resistances Are Suitable in this Circuit.

- C<sub>1</sub> = .0005 M.F.
- C<sub>2</sub> = .001 "
- C<sub>3</sub> = .00025 "
- C<sub>4</sub> = .0005 "
- C<sub>5</sub> = .0001 "
- C<sub>6</sub> = .001 M.F.
- C<sub>7</sub> = 2 "
- R<sub>1</sub> = 50,000 to 70,000 ohms
- R<sub>2</sub> = 3 megohms
- R<sub>3</sub> = 1 "

Q 624

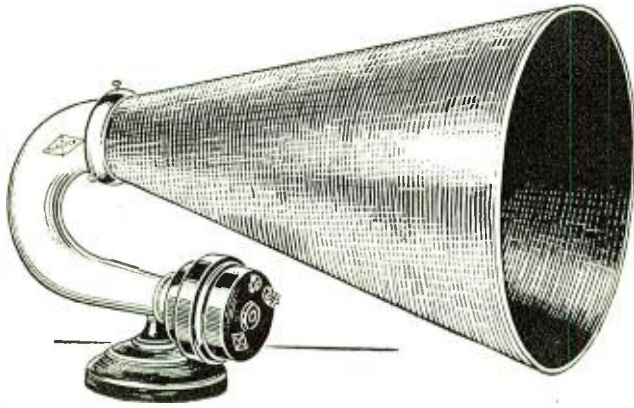

**\$5**

*For the new*  
**MURDOCK  
LOUDSPEAKER**

*Complete with new  
loudspeaker phone unit.  
The sensation of radio  
at an unheard of price.  
Backed by the oldest  
manufacturer of Radio  
head phones. Get one today  
from your dealer.*

**WM. J. MURDOCK CO.**

344 Washington Ave., Chelsea (Boston) Mass.

*Sales Offices:*

Wilson Bldg. . . . . New York  
509 Mission St. . . . . San Francisco  
524 Marquette Bldg. . . . . Chicago

FOR over 18 years Murdock Headphones have been used by Radio experts all over the world—they have given universal satisfaction because they are scientifically correct for the best reproduction of sound.

Insist on Murdock phones when purchasing.

If your dealer cannot supply you with Murdock Apparatus send remittance direct and your order will be filled.

**DEALERS**

Write us for full information about the new Murdock Loudspeaker. Get on our list.

**MURDOCK HEADPHONES**

No. 56—2,000 Ohms

**\$5.00**

No. 56—3,000 Ohms, \$5.50

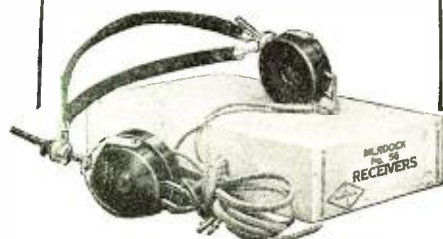

# MURDOCK RADIO

**STANDARD APPARATUS SINCE 1904**

**COMBINATION VERNIER  
and  
VARIABLE CONDENSERS  
43 and 23 Plate**



**Built to give long Service**

**Construction**

Metal end plates supported by best grade insulating material.  
Rotor and Vernier supported by and turn in metal bearings.  
Plates will always remain in true position.  
All metal used is non-magnetic.  
These models have been calibrated. The 43 plate has a ratio of 1-40 between minimum and maximum capacities. The vernier has a capacity effect equal to approximately three points on the dial.

**List Prices**

Vernier Panel type 43 plate Cap. .0012	
M. F. ....	\$6.75
Vernier Panel type 23 plate Cap. .00056	
M. F. ....	6.25
Vernier Table type 43 plate with 3-in. bakelite dial. ....	8.00
Vernier Table type 23 plate with 3-in. bakelite dial. ....	7.50
Regular type Variable Condensers:	
43 plate. ....	\$4.50
23 " ....	4.00
11 " ....	3.50
3 " Vernier. ....	3.00

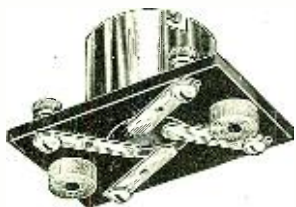

**P. M. T. Co. Tube Socket**

Heavy insulation base. Polished nickel brass socket. Phosphor bronze silver plated contact points, so spaced as to eliminate possible capacity effect.

Price 75 cents



**P. M. T. Co. Tubular Mounting**

Heavy fibre base and phosphor bronze contact springs. Price. ....50c

**P. M. T. Co. Audio Frequency Transformer**

gives the highest amplification possible without in any way causing noisy circuits. Very efficient and has superior electrical characteristics. Positively guaranteed.

Price \$4.50

Distributors and Dealers Wanted

**Pittsfield Machine & Tool Company**  
Pittsfield, Mass.

**Electrons, Electric Waves and Wireless Telephony**

(Continued from page 1617.)

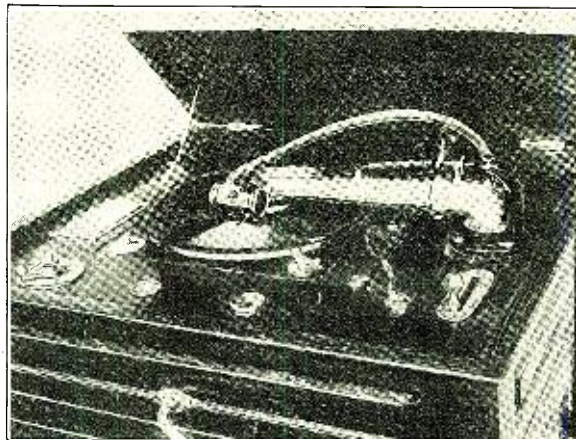

Fig. 32.—The Tone Arm, Valve, Air Delivery Pipe and Record on a Creed Stentorphone.

locating the position of a source of sound and in providing means for measuring the depth of the sea.

Very familiar experiences show us that a sound wave takes time to travel through the air. The delay in hearing the noise of thunder after seeing the lightning, or the explosion of a gun or rocket after seeing the flash or burst, shows that this is the case.

Modern methods of measuring extremely small intervals of time and of detecting feeble sounds have greatly increased the accuracy with which air wave velocity can be measured.

The following rather rough lecture experiment was devised by the writer for showing to a public audience that a sound wave takes a perceptible time to travel a distance of even a few feet.

A couple of zinc tubes, each about 2½ ins. in diameter and 15 feet long, were united by a bend at one end so as to make a U-shaped tube, 30 ft. long. One end of this tube was covered with a diaphragm of thin sheet india-rubber, put on like the cover of a pot of jam. The other end of the tube was stopped with a cork. Two tin funnels were provided, the wide ends of which were similarly covered with india-rubber sheet, and the spouts were inserted in holes in the long tubes, one near the cork-closed end and the other near the rubber-covered end.

If a sudden tap is given to the cover of this funnel by a little metal drumstick, it starts a wave of compression which runs along the zinc tube. On the rubber cover of the funnel was fixed a little metal disc and matters were so arranged that the act of striking the tight rubber cover of the funnel, strained on it like a drumhead, closed an electric circuit, as well as started an air wave traveling down the zinc tube. When that air wave reached the thin rubber cover at the far end of the tube it caused it to bulge out, and in so doing, to knock over a trigger and break or interrupt the electric circuit closed in the act of starting the wave. In this circuit was inserted an instrument called a milli-ampere meter, in which an indicating needle or index arm is moved through a certain angle by an electric current passing for a certain time. If, then, the air wave takes time

to travel along the tube, a certain interval of time will elapse between the closing of the electric circuit by striking the funnel drum-head, and its interruption when the air wave, so created reaches the far end and knocks over the trigger. From the deflection of the needle of the amperemeter, which then takes place, we can estimate the time taken for the air wave to travel 30 feet along the tube. From experiments made, it appears to be rather more than one thirty-fifth part of a second, which shows that an air wave travels at the rate of 1,100 feet per second.

Much more exact experiments of this kind have been made and described recently by Messrs. Dixon, Campbell and Parker (see *Proceedings of the Royal Society*, London: Series A, Vol. 100, October, 1921, p. 1).

They have measured with great accuracy the velocity of compressional waves in various gases at different temperatures and in tubes made of several kinds of material.

In air at 10° Centigrade they found the velocity to be 334.4 meters per second, which is equal to 1,097 ft. per second.

It has been found, however, that very loud sounds certainly travel much faster in open air than sounds of moderate intensity.

It was pointed out as far back at 1808 by the French mathematician, Poisson, that the mathematical theory of the propagation of waves of large amplitude is entirely different from that which is valid when waves of small amplitude are considered. In 1900, M. Vieille, Engineer-in-chief of the French Ordnance Bureau, showed that the velocity of the air wave produced by bursting open a thin metal disc by an air pressure of 400 lbs. on the square inch was nearly double that of ordinary sound, whilst the air waves produced by the detonation of high explosives was nearly three times the normal.

If the velocity of an air wave is known, and if the interval of time between its arrival at two places, the distance apart of which is known can be measured, then we can locate the direction of the source of sound. For instance, suppose *A* and *B* (see Fig. 34) to be two places, the distance *AB* being known. If a sound wave sent out from some distant source arrives simultaneously

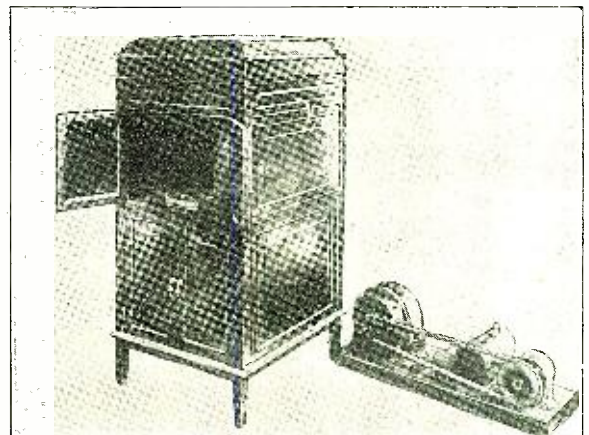

Fig. 33.—View of a Creed Stentorphone Cabinet, and of the Electric Motor Driving the Air Compressor Pump for Supplying the Compressed Air.

# CLAPP-EASTHAM CO.

## ANNOUNCE

# Two New Radak Sets

## *Models R23 and A23*

(Licensed under Armstrong U. S. Pat. 1113149)

After a period of exhaustive experimentation and proving, we are now ready to present Radak Equipment embodying the important feature of

### RADIO FREQUENCY AMPLIFICATION

In our new Radak Models R23 and A23 we offer a combination which we believe represents the highest development in equipment for radio receiving.

These two units together give the operator a new and greater selectivity, combined with increased distance, surprising loudness and clearness of reception, remarkable freedom from interference, and a wave-length range of 175 to 225 meters.

Model R23 is a complete unit embodying the tuning elements. It contains two adjustments—one for tuning the antenna circuit, the other for tuning the plate circuit. Both adjustments employ the *new Radak vernier dials*—a great advance in ease of adjustment. The front panel presents a neat, orderly appearance, as all binding posts are *inside* the cabinet and all wires are connected from the back of the cabinet.

Model A23 Radak contains both the detecting and amplifying elements. These include both *audio* and *radio* amplification. This unit requires only one adjustment, aside from the rheostats controlling the brilliancy of the filaments. This adjustment employs also the sensitive new Radak vernier dial. Like Model R23, the binding posts are inside, out of sight, and the wires are behind.

When connected together, these two Radak units, provide—  
a tuned plate regenerative receiving set—  
one stage of *radio frequency amplification*, and—  
one stage *audio frequency amplification*.

And they present these features with an unexpected simplicity of design, doing away with the only too common multiplicity of knobs, dials and switches. There are no grid-biasing potentiometers, no adjustable or other grid leaks. Three simple tuning dials and two filament rheostats do the work.

### THE ALL-YEAR-ROUND SET

This is the ideal receiving set for all seasons of the year, under their varying atmospheric conditions. Its employment of radio frequency affords such sharp tuning that outside interference is eliminated to a really remarkable degree. Use this set at your home now and carry it with you to your seashore or mountain camp or cottage this summer.

For finest results in radio receiving, we strongly recommend these two units in combination. However, Model A23 may be used in conjunction with any good regenerative receiver having a tuned plate circuit, but without the detector mounted—in other words having variometer control of the regeneration.

Both units are contained in handsome mahogany cabinets of unique design and are companion pieces in dimensions and finish. The price together is \$100. Separately, Model A23 \$60, Model R23 \$40.

*Send for complete Radak catalog, enclosing 6c postage.*

## CLAPP-EASTHAM COMPANY

Est. 1907. Oldest, Largest, Exclusive Radio Equipment Manufacturers in America

107 Main St., Cambridge, Mass.

makers of

# Radak

*Reg. U. S. Pat. Off.*

***Reliable Radio Equipment***

# CURKOIDS

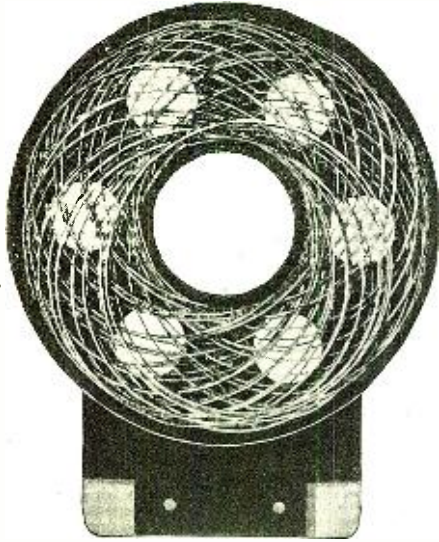

PATENT PENDING

## What They Are

**CURKOIDS** are inductances wound in the form of curtate epitrochoids.

This form of winding *does* result in minimum distributed capacity and maximum concentration of the valuable inductance.

Curkoid Couplers are triple mounts so designed that the coupling movement is parallel with the common center of the coils, this movement being in low ratio to the manual operation of the dial, giving micrometer adjustment of the mutual inductive fields.

This slow parallel movement in the coupling, in combination with entirely "loose" coupling, results in the *utmost selectivity* in tuning.

With "loose" coupling by Curkoid Parallel Inductance, maximum volume and distortionless tone in broadcast reception are obtained, while with "tight" coupling, spark reception of maximum intensity is accomplished. Long distance stations are selected with signal strength at maximum.

### Remember

Parallel Inductance — Distributed Capacity + Super-Inductance = Utmost Selectivity

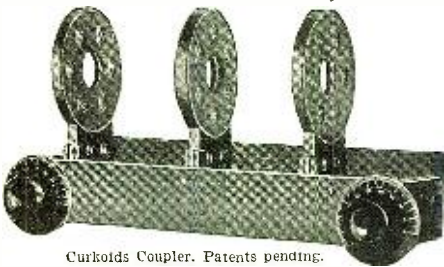

Curkoids Coupler. Patents pending.

Coupler ..... \$ 6.00

### Curkoids

No. 20K.....\$1.20	No. 250K.....\$2.10
No. 25K.....1.25	No. 300K.....2.20
No. 35K.....1.35	No. 400K.....2.30
No. 50K.....1.50	No. 500K.....2.50
No. 75K.....1.60	No. 600K.....2.70
No. 100K.....1.70	No. 750K.....3.00
No. 150K.....1.80	No. 1000K.....3.30
No. 200K.....1.90	No. 1250K.....3.75
No. 1500K.....4.25	

Order your Curkoid System Today. The system that enables the clear Reception of **DIS-TANT STATIONS** and the ability to hold them **Audible and Strong** without interference.

Send us your order with the name and address of your dealer and we will see that you are supplied.

**Rieger Research Corporation**  
112 West 44th St., New York, N. Y.

at *A* and *B*, then we know that the source of sound must be somewhere in a line perpendicular to *AB*, and passing through the point half-way between them.

If the places *A* and *B* are, say, 1,100 ft. apart, and if we are dealing with ordinary not very loud sounds, and if the air wave arrives at *A* one second before it reaches *B*, then we know the source of sound must be on the line *AB* and in the direction *BA*, produced.

If the difference in times of arrival of the sound at *A* and at *B* is, say, half a second, then we can find the direction in which the sound is coming as follows. Draw to scale a line *AB* (see Fig. 34) and let this represent the distance traveled over by sound in one second. Describe as *AB* a semi-circle and find a point *C* on that curve, such that *AC* is equal to half *AB*. Then join *BC* and from the center *O* of the semi-circle draw a line *OD* perpendicular to *BC*. Then if the sound is first heard at *B* and half a second after at *A*, the sound wave is coming in the direction *D.O*. If then we have another pair of similar observing stations, we can determine another line of travel of the air wave and hence from the intersection of these two lines the place of origin of the sound.

A somewhat similar method of operation

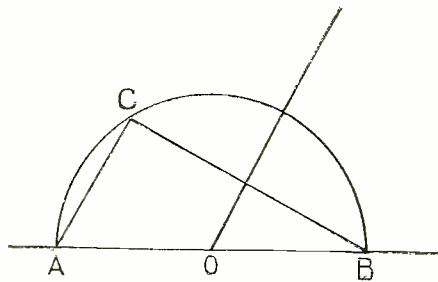

Fig. 34.—Locating the Direction of a Sound Wave.

called sound ranging was employed during the European War, 1914-18, for locating the position of enemy guns. Large corrections have, however, to be made for wind and other disturbing causes.

### Molecules and Atoms

Before we can discuss the nature and properties of another type of wave called an electromagnetic wave, it will be necessary to consider briefly some of the things which modern researches have taught us concerning the structure of atoms, and the elements of which they are built up.

Twenty-five years ago no one could have given any information on this subject. In fact, even the actual existence of atoms was then in doubt. The word *atom*, derived from Greek verbal roots, signifies something which cannot be cut or divided, and any discussion on the structure of the interior of an atom would in those days have been very similar to the contents of a chapter in an old book on Natural History, headed "On Snakes in Iceland," the only information given therein being, "There are no snakes in Iceland."

So with atoms the only answer to questions as to the structure of an atom would then have been, "we know nothing about their structure and probably never shall know anything."

Although Greek philosophers twenty-five centuries ago had taught that material substances are composed of small discrete indivisible particles, no one had formulated any theory as to their inner construction, and they were only mentally pictured as extremely small spheres infinitely hard and of unknown composition. But the atomic theories of classical philosophers, such as Democritus and Lucretius, were mere speculations and had no basis in observed facts.

It was not until modern chemistry came

into being by the discoveries of Cavendish, Boyle, Black, Lavoisier and Dalton, in the eighteenth and early nineteenth centuries, that valid reasons began to be given for the belief that material substance, in short, all matter is not infinitely divisible, but is composed of definite units of mass called molecules and atoms.

Suppose we consider such a substance as common table salt. We can divide it into small grains and each of these could be divided again under a microscope until we reach a particle nearly 1/100,000th of an inch in diameter, which is about the smallest size of particle visible in a good microscope. We have good reason to believe that even such a small particle would possess all the known qualities of common table salt. If we dissolve some salt in water and make a solution, no microscope yet made can show any visible particles in it, yet each drop of the liquid would taste "salt" and exhibit all the properties of common salt in chemical actions. Moreover, by an evaporation or boiling off the water we can recover the salt unaltered.

Hence we have good reason to believe that when in solution the salt is divided into particles of ultra microscopic size. But chemical experiments show that this substance can yield under the action of an agency called an electric current, the nature of which we shall consider immediately, two other substances, viz., a green poisonous gas, chlorine, and a soft metal, sodium, and therefore common table salt is called in chemical language, sodic chloride.

Moreover, effects we shall discuss later on prove that in very dilute solutions of sodic chloride, and other similar salts which conduct electric currents and are decomposed by them, the constituents, which in this case are chlorine and sodium, exist partly in an uncombined state.

Hence there is a certain small mass of sodic chloride which is the least possible mass which exhibits all the properties of common salt. It is called a *molecule* of sodic chloride.

The word molecule is derived from Latin words and means a small mass or quantity. There are various substances, about 90 in all, which have never been resolved or decomposed into any other substances and these are called *elements*. The smallest possible quantity or mass of any element which can exist as such and exhibit the chemical properties of the substance is called an *atom* of it.

Hence the molecules of complex substances are built up of atoms held together so as to form small similar bunches or groups. In certain very simple compounds such as table salt, the molecule may consist of only two dissimilar atoms, but in organic substances, such as albumen, oils, or starch, the molecule may contain many scores or even hundreds of atoms.

Even in elementary substances such as hydrogen or oxygen in the gaseous state, the constituent molecules contain two similar atoms held together.

We have been able to determine by methods which cannot here be described in detail, the mass or so-called weight and also approximately the size of molecules and atoms.

The view that small definite units of mass, called atoms, exist in the case of the elementary substances is strongly supported by the three laws of chemical combination, viz., Proust's Law of Definite Proportions, the Law of Relative Proportions and Dalton's Law of Multiple Proportions. These may be illustrated as follows: Every pure chemical compound is composed of elementary substances always in the same definite and constant proportion by weight. Thus water consists of 16 parts by weight of the gas oxygen combined with 2.016 parts by weight of the gas hydrogen, which combine and produce pure water when the

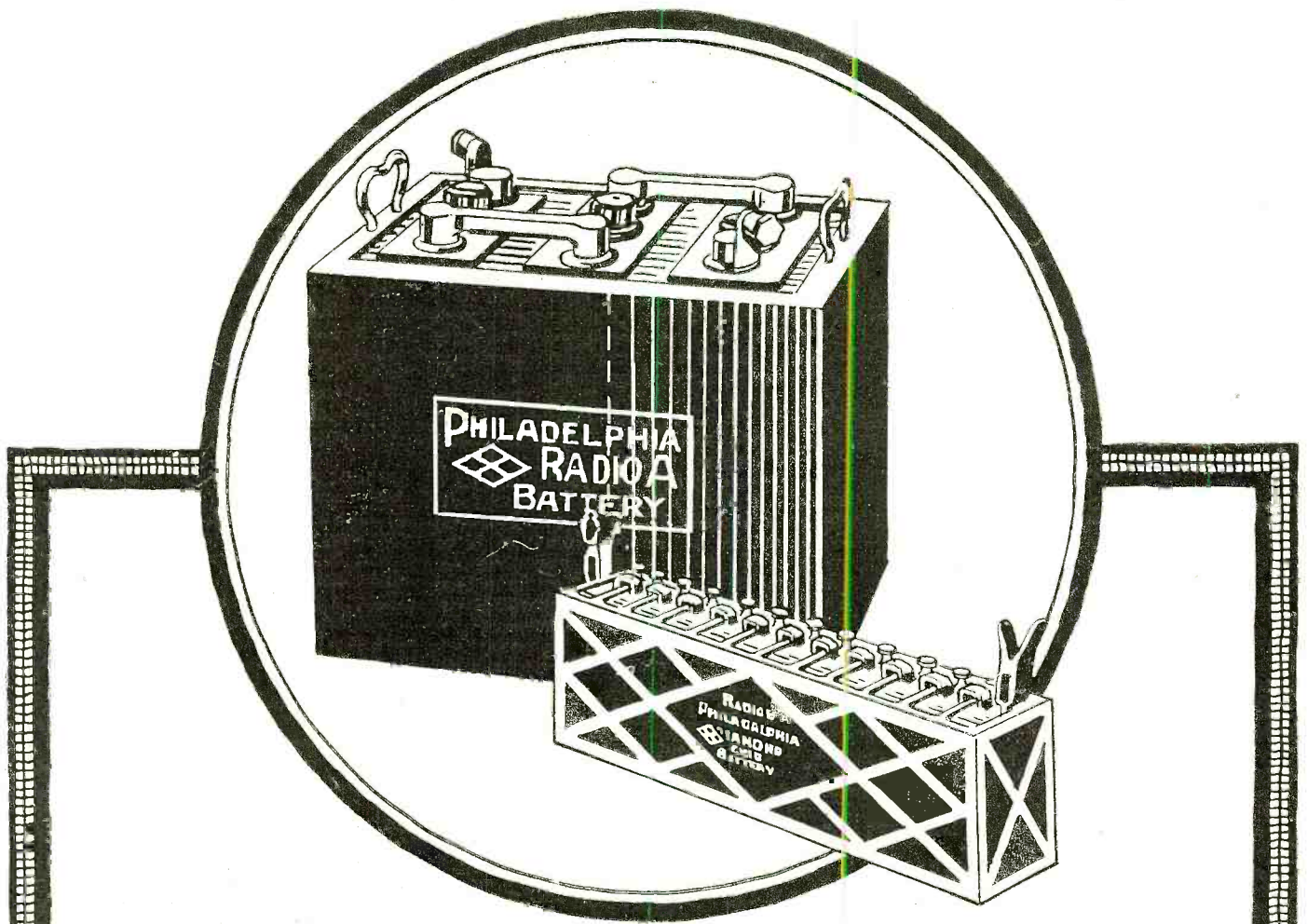

*Why thousands of radio owners*

## Demand Philco Batteries

No frying, cracking battery noises. No frequent, troublesome tuning in. And they last longer, demand less care and give longer service per charge than any other radio batteries ever built.

What's equally important, there's no waiting for initial charging—no paying for battery life and current lost on the dealer's shelf. Their life starts when you pour in the Philco Electrolyte—not months earlier at the factory.

Philco Drynamic Radio Batteries are built by the makers of the famous long-life, high-powered Philco Slotted-Retainer Batteries—standard for automobiles, mine locomotives and other heavy-duty services.

You'll want to know more about these remarkable radio storage batteries. See your radio dealer—the nearest Philadelphia Diamond-Grid Battery Service Station—or fill out the attached coupon and mail to us at once.

**R**ADIO DEALERS—Philco Drynamic Batteries let you into the storage battery business on a package goods basis. No acid sloppage. No charging equipment. No batteries going bad in stock. Wire or write for details. **D**

**Philadelphia Storage Battery Company, Philadelphia**

# PHILCO

DRYNAMIC RADIO BATTERIES

**Mail This Coupon Today**

Sirs: I want to know more about the new Philco Drynamic Radio Batteries.

Name .....

Street .....

City .....

State .....

Business .....



## CLEARNESS OF TONE

sensitiveness in receiving signals over a wide range, comfort, and adjustability are the distinguishing characteristics of the

### Stromberg-Carlson Radio Headset

Made by a firm which has devoted 8 years to the manufacture of radio apparatus, backed by 28 years' experience in the manufacture of high grade telephone equipment.

The forked cord construction permits the separation of the receivers so that two observers may "listen in" simultaneously.

Order Stromberg-Carlson apparatus through your electrical merchandise dealer or write for free bulletin No. 1029-R describing exclusive Stromberg-Carlson features.

**STROMBERG-CARLSON  
TELEPHONE MFG. COMPANY**

Rochester, N. Y.



gases are mixed and an electric spark sent through them. When the analysis of a pure compound is conducted with proper care it invariably yields the same proportions of its constituent elements.

The Law of Multiple Proportion may be known compounds of carbon (charcoal) and oxygen gas, viz., carbon monoxide (CO), a very poisonous gas, and carbon dioxide (CO<sub>2</sub>). In the first, the ratio of mass of carbon to oxygen is 12 to 16, and in the second it is 12 to 32. The ratio of oxygen to carbon in the second is just double that in the first. It is found that whenever there is more than one compound of two elements, the ratio by weight of these elements in the two compounds is always in a simple integer proportion.

The Law of Relative Proportion is as follows: Consider three elements, hydrogen, oxygen and carbon. The first two combine in the proportion of 1 to 8 or 2 to 16, to form water. The second and third combine in the ratio of 16 to 12 to form carbon monoxide. Finally, the first and third combine in the ratio of 2 to 12 to form a gas called olefiant gas. We see then that to each element may be affixed a certain numerical value called its *chemical equivalent*, and combinations between elements always take place in the proportion by weight of the equivalents, or in some integer multiples thereof.

These facts, and many others like them, point very significantly to the conclusion that elementary substances exist in small ultimate units which are of exactly the same mass and enter into all chemical reactions without change of mass.

In short, matter is atomic in structure. Atoms unite to form molecules and molecules to form visible masses, just as letters are combined to form words and words to form sentences.

The relative mass or so-called weights of each kind of atom has been measured and is called the *Atomic weight*. It is expressed in terms either of the mass of the hydrogen atom taken as equal to 1, or of the oxygen atom taken as equal to 16. The *Molecular weight* of a molecule is the sum of the masses of the constituent atoms. Two terms, viz., a *gram-molecule* and a *gram-atom* are in frequent use. These mean respectively the quantity of a chemical substance or of an element which has a mass in grams numerically equal either to the molecular or the atomic weight. Thus the atomic weight of oxygen being 16, a quantity of oxygen weighing 16 grams is called one gram-atom of oxygen. The atomic weight of sodium is 23 and of chlorine is 35.47. Hence the molecular weight of sodic chloride or table salt is 58.47, and a mass of salt weighing 58.47 grams is called one gram-molecule of sodic chloride.

According to an hypothesis first made by the chemist Avogadro, in 1811, a gram-molecule of every kind of substance contains the same number of molecules.

In the case of permanent gases taken at standard temperature 0°C. and barometric pressure 760 mm., equal volumes therefore contain the same number of molecules and a gram-molecule occupies a volume of 22,400 cubic centimeters.

Thus 2 grams of hydrogen, 32 grams of oxygen, 28 grams of nitrogen, all have a volume of 22,400 c.c. at 0°C. and 760 mm. and contain an equal number of molecules, that number being very near to  $66 \times 10^{23}$  or 660,000 times a million billion in English reckoning.

This means that in one cubic centimeter there are about 30 million billion molecules. In a space of one-half of a cubic millimeter, or about the volume of a small pin's head, there are ten million times more molecules of air than there are human beings alive on the surface of our earth at present. This will give some faint idea of the exceeding

minuteness and number of the molecules in the air we breathe.

Non-scientific persons are apt to imagine that these figures are mere guess work, but this is not the case. We can now count by various methods the number of molecules in a cubic inch of air with quite as close an approximation to truth as we can count the number of men, women and children in Great Britain by a census taken on the night of any given date.

#### Dimensions of Atoms

As regards the sizes of atoms and molecules there are various lines of argument which lead to the conclusion that approximately speaking, the diameter of an atom is of the order of one hundred millionth of a centimeter. This means that if a million atoms were placed in contact like marbles arranged in a row, they would only occupy a length of 1/250th part of an inch, or less than the thickness of the thinnest sheet of tissue paper. To count this million atoms would take at least a week, counting without stopping day and night.

An approximate measurement of atomic diameters is derived from the study of thin films of various kinds.

Skilled gold beaters can beat out one ounce of gold until it covers an area of 240 square feet. The thickness of the sheet would then be about four-millionths of an inch.

There are three units of length which are convenient for measuring very small lengths or thicknesses and these are as follows:—

A *millimeter* (1 mm.) is the thousandth part of a meter and is about 1/25th part of an inch.

A *micron* ( $\mu$ ) is the thousandth part of a millimeter.

An *Angström unit* (1 A.U.) is the ten-millionth part of a millimeter and therefore the ten-thousandth part of a micron or  $10,000 \text{ A.U.} = 1 \mu$ .

Roughly speaking, the diameter of an atom is about two to five Angström units.

It is possible to prepare gold leaf the thickness of which is about one-tenth of a micron or 1,000 A.U. Such leaf when held up to the light has a green color, or is semi-transparent and transmits green light.

This gold leaf has, however, several hundred layers of atoms in its thickness, probably 300 to 500 atoms. We can, however, prepare thinner films of soapy water. If a soap bubble is blown with a suitable material, or better still, if a metal ring is filled with a soap film by dipping it into the soap mixture, and if this film is placed in glass dust-free box in a vertical position, the film begins to thin away by drainage from the top part. Presently we notice certain small round black spots which look like holes, but are not holes, because in proper positions we can see an image of a bright light source, such as the sun reflected by them. It is possible to measure by several methods the thickness of the film in these black spots. It is found to be about 60 A.U. or six thousandths of a micron. This film, however, must be of a thickness equal to the diameter of several atoms.

The late Lord Rayleigh (3rd Baron) measured the thickness of still thinner films of oil floating on the surface of water and found them to be about 20 Angström units (A.U.) in thickness ( $= 2 \times 10^{-7} \text{ cm}$ ).

M. Devaux, by another method, produced films of oil on water of half the above thickness, viz., 10 A.U. In this last case the film is probably formed of a single layer of molecules of oil, and hence, we see that molecular diameters must be between  $1/10^8$  and  $1/10^9$  of a centimeter, or approximately be of the order of one hundred millionth of a centimeter, or from one to five times this last length.

At this stage we must, however, define a little more carefully what we mean by the diameter of an atom or molecule. We shall







NOW  
\$1.50

**KLOSNER VERNIER RHEOSTAT**  
THE FIRST — THE BEST

This rheostat, the result of experience gained by us as pioneer manufacturers of the Vernier Rheostat, is conceded by many to be the best on the market. Base and dial of genuine Condensite, and all metal parts highly finished. A real masterpiece of design and workmanship, and its new price now makes it the most popular.

NEW KLOSNER PRODUCTS

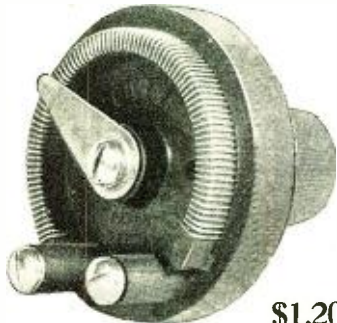

\$1.20

**NON-VERNIER RHEOSTAT**

Created to fill the demand for a rheostat of the same high grade construction and outward appearance as our Vernier Rheostat, but without the Vernier. For use with tubes not requiring a delicate filament adjustment. Has the same resistance of six ohms, and runs unusually smooth.

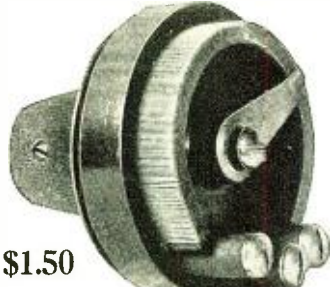

\$1.50

**POTENTIOMETER**

Another addition to the Klosner line of superior products. Used in many parts of your set to increase the sensitivity and loudness of concerts or code. Consists of a regular Klosner rheostat base, with a smoothly wound resistance of 225 ohms. Allows very accurate control, and has an adjustment "smoother than velvet."

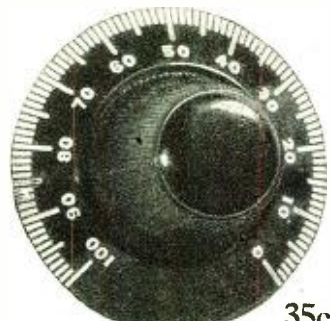

35c

**TWO INCH DIAL**

Here is that handsome dial which is used on all Klosner instruments. Moulded in one solid piece of genuine indestructible Condensite—it will never warp or lose its rich black luster under any conditions. Made to fit any standard rheostat or potentiometer with numerals on edge for easy reading. Has a 1/4 inch hole and a cup pointed set screw to insure a firm grip on the shaft. Does not scrape on the panel. A beautiful dial to have on your panel—will make your old rheostat or potentiometer look 100 per cent better.

All of the above instruments are sold by leading dealers everywhere. If yours hasn't any, don't be satisfied with something "just as good," but send us in your order direct, mentioning his name. Send for FREE literature.

These products are fully guaranteed against any defects by the manufacturers, the Klosner Improved Apparatus Co., 2024 Boston Road, New York City.

**KLOSNER**

show presently that atoms are not solid, sharply defined masses like billiard balls, but in all probability resemble solar systems in miniature, in which a number of still smaller particles circulate round a nucleus like planets round the sun.

3.—THE KINETIC THEORY OF GASES.

It will be necessary, therefore, to sketch in outline the kinetic theory of gases or theory of the motion of gas molecules.

In a mass of air or gas the constituent molecules are not at rest, but flying hither and thither with immense and various speeds in every possible direction. We know that this must be the case from the facts of diffusion. If we have two vessels, one full of air or other gas and the other exhausted or vacuous, and if they are connected by a pipe in which there is a plug of porous clay or unglazed earthenware, we find that after a time some of the gas will have passed through the plug and diffused into the vacuous space. Also if the two vessels contain gases of different densities, but at the same pressure such as hydrogen and oxygen, then they both diffuse in opposite directions, but the lighter gas diffuses faster than the heavier gas. In a certain time the gases will have mixed completely so that each vessel will contain the same proportion of each gas.

We know that the gas in any closed vessel exerts a pressure on the walls. This pressure is a force in a dynamical sense of the word, and is due to the bombardment of the walls by these flying molecules. Let us suppose that there are  $N$  molecules in one cubic centimeter and that each molecule has a mass  $m$  and is moving with a velocity  $v$ . This velocity is not the same for all molecules, some are moving quickly and some slowly at any instant. Of the  $N$  molecules we may suppose one-third or  $N/3$  to be moving at any instant perpendicularly to one surface of the cube of 1 cm. in side and 1 square centimeter in area. If we take  $v$  to be an average velocity then  $mv$  is the average momentum of each molecule, and when it strikes the side of the cube and rebounds from it, its momentum  $+mv$  is changed in direction to  $-mv$  in the time taken for the molecule to move over a distance of 2 cms. Hence the change in momentum is  $2mv$  in a time  $2/v$  seconds.

Force is defined as the rate of change of momentum and the time rate of change of momentum or force is in this case  $2mv$

$\frac{2}{2} = mv^2$ . Hence the pressure on the

side of the cube due to the  $N/3$  molecules is  $\frac{1}{3} Nmv^2$ .

Suppose we now take  $v$  to be, not the actual velocity of one molecule, but the square root of the mean of the squares of all the various molecular velocities, called the R.M.S. velocity, then since  $Nm$  is the mass of the gas in 1 c.c. =  $d$ , we have for the gas pressure  $p$  on a surface of one square centimeter the expression

$$p = \frac{1}{3}dv^2$$

Hence it follows that the mean square velocity  $v^2$  is  $3p/d$  and the root-mean-square velocity  $v$  is  $\sqrt{3p/d}$ , where  $d$  denotes the absolute gas density.

The pressure of a gas per square centimeter measured in absolute units of force, called dynes, which corresponds to a height of the barometer of 760 mm. or nearly 30 inches of mercury and at 0°C. is very nearly one million dynes, and the density of hydrogen gas is 1/11,200 because 11,200 c.c. of this gas weigh one gram. Hence the R.M.S. speed of the hydrogen molecule is  $\sqrt{3 \times 10^6 \times 11,200}$  centimeters or 1,830 meters per second.

In the case of oxygen, which is 16 times denser than hydrogen, the R.M.S. speed of

the molecule is close to 460 meters per second.

It is important that the reader should clearly understand what the above statements imply.

The gas molecules are flying in all possible directions and with very different speeds. If we could divide up the molecules into a very large number of groups of nearly equal velocity according to their speed, but without taking regard to direction of motion, we should find that a very small number of molecules had a zero or very small velocity and a very few had a considerable velocity, but the great majority approximate in speed to a certain "most probable speed," which is very nearly the same as that obtained by squaring the numerical value of the speeds of the different groups and then taking the square root of the mean of these squares, in other words, obtaining the R.M.S. speed.

Clerk Maxwell was the first to give a general law in the form of a mathematical

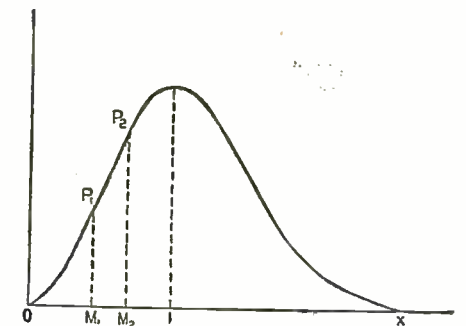

Fig. 35. Maxwell's Curve Graph of  $y = x^2e^{-x^2}$

expression and to give a curve for the distribution of velocity among gas molecules. The curve shown in Fig. 35 is a curve whose equation is

$$y = x^2e^{-x^2}$$

Where  $e = 2.71828 \dots$  etc., viz., the base of the Napierian system of logarithms. The curve is so drawn that the abscissa  $OI$  of the maximum ordinate is taken as equal to unity. The value of  $y$  is zero both for  $x=0$  and  $x=\infty$ . If we take two ordinates  $P_1M_1, P_2M_2$ , then it can be shown that the value of the area  $P_1M_1M_2P_2$  multiplied by  $4/\pi$  gives the fraction of the number of gas molecules in any volume, the speeds of which lie between values denoted by the abscissae  $OM_1$  and  $OM_2$ .

Thus, for instance, in the case of oxygen gas molecules, whose R.M.S. speed is 461.2 meters per second, the following table taken from Meyer's *Kinetic Theory of Gases*, gives the speed of various groups of molecules in meters per second.

		Meters per second	
13 to 14	81	0 to 100	200
81	166	100	300
166	214	200	400
214	202	300	500
202	151	400	500
151	91	500	700
91	76	600	700
76		700	above

It will thus be seen that all but about 10 per cent. of the molecules have speeds which lie between half and double the R.M.S. speed of 461 meters per second.

It will thus be evident that in a mass of oxygen gas the molecules are flying about in all directions for the most part with speeds which lie between 500 and 2,000 miles an hour. A very few are moving more slowly and a few more quickly.

In the case of hydrogen gas which has an R.M.S. speed about four times greater than oxygen, the molecules are moving for the most part with speeds from 2,000 to 8,000 miles an hour or 100 times faster than express trains.

In the course of this extremely rapid motion the gas molecules collide with one another. The average distance they move

*Ask your dealer to show you the*

# MAR-CO LINE of RADIO Products

*Perfect in Design, Finish, and Workmanship*  
 MAR-CO Products are Electrically Correct

**Shur-Grip Plug \$1.50**  
 NICKEL FINISH. No tools necessary to connect. The Perfect Plug.

**MAR-CO W.D.11 Tube Socket 75c.**  
 Compact. Positive contact. Easy to mount.

**Sta-Put Plug 60c.**  
 Practical—Efficient—Reliable—No tools to connect.

**MAR-CO W.D.11 Tube Adapter 65c.**  
 An adapter that is electrically and mechanically perfect.

**MAR-CO Jacks 65c-\$1.10**  
 (Five styles). Open, Single, Double Circuit, Single and Double Filament. Control. Built to give a lifetime of service—Formica insulation.

**MAR-CO Pull Switch 90c.**  
 A simple practical battery switch. Only one hole necessary for panel mounting.

**MAR-CO Vernier Rheostat \$1.50**  
 Remarkably fine adjustment. Critical Filament easily controlled. 6 ohms resistance. 2 ampere capacity. Also very effective in use with WD11 Tube.

**MAR-CO Inductance Coils 40c-50c.**  
 Three sizes.

**MAR-CO Standard V. T. Socket 90c.**  
 A perfect reinforced bakelite socket—double contact.

**MAR-CO Tuner \$7.00**  
 A radical new development in tuning devices.

## MARTIN - COPELAND COMPANY



Providence, R. I.



# The 1001st!

—but dealers will find it the first

**CORRECT!** The radio industry has been flooded with books and catalogs galore. Especially has the radio dealer been bombarded with his share. But now comes the thousand and first radio book, *that is, the first* which is both catalog and mentor to the dealer and public alike.

This book doesn't sell for five dollars, or fifty cents or one red cent. But to get it, friend reader, you must do one thing, and do it clearly and distinctly. If you will carefully extract your trusty Waterman from your inside vest pocket, give it a tentative shake, and print your name so our mailing department won't need to use a magnifying glass or a Sherlock Holmes to detect its significance, we will be glad to send you without one penny (red, blue or otherwise) your own individual and autographed copy of a catalog that is more than a catalog—a book that will prove your adviser and friend.

Within you will find illustrated and priced the most deservedly popular finished sets, construction sets and parts of such well known companies as Western Electric, De Forest, Acme, Sleeper, Murdock, Stromberg-Carlson, Marshall-Gerken, Atwater-Kent, Klosner, Dubilier, Briggs & Stratton, Thordarson and others.

Sign on the dotted line and Uncle Sam will do the rest.

THE NORTH AMERICAN RADIO & SUPPLY CORPORATION

5 Columbus Circle - New York City

Please send me that catalog you say so much about.

Name.....  
Street.....  
City.....

**GENUINE GERMAN MAUSER**



Latest model 9 shot automatic. Shoots standard cartridges—lies flat in pocket—World's famous Luger 30 cal. \$20.75 — Hand Ejector Revolver, swing out cylinder 32 cal. \$16.95. 38 cal. \$17.95. All brand new latest models. Guaranteed genuine imported. Pay on Delivery **SEND NO MONEY** Plus Postage

Satisfaction guaranteed or money promptly refunded.  
25 cal. Pocket Automatic; 25 cal. Blue Steel Army Automatic \$8.45; 32 cal. \$10.45; Officer's Automatic, 3 safeties, 25 cal. \$11.95; Military Trench Automatic, 32 cal. 10 shot extra magazine FREE, \$11.65. Just like you used over there. Imported Top Brake Revolver. 32 cal. \$8.65; 38 cal. \$8.95.  
**\$6.95**  
Universal Sales Co. 141 B'way, Desk 282 New York

FREE

Complete price list of radio parts. Write Aitken Radio Co., 504 Superior St., Toledo, Ohio.

over between two collisions is called the *mean free path*.

In the case of air at normal pressure and temperature the mean free path is about 1/250,000th part of an inch or 1/10,000th part of a millimeter, or 1/10th of a micron. This is roughly about 500 times the diameter of a gas molecule. The mean free path varies inversely as the pressure of gas. Hence, if we make a so-called vacuum by removing all but one-millionth of the air from a vessel, the mean free path is increased to about four inches in length.

We can now give a more exact definition of what is meant by the diameter of an atom or molecule. It is the least distance between the centers of two atoms or molecules at their closest approach during a collision.

If *D* is the diameter of the sphere of impact or atomic diameter as defined above, and if *N* is Avogadro's constant or the number of molecules in a gram-molecule, and if *V* is the volume of this gram-molecule and *L* is the mean free path, then Clausius showed long ago that the relation between these quantities is given by the equation  $\pi \sqrt{2} L N D^2 = V$  where  $\pi$  is the circular constant 3.1415....

From this equation we can obtain, as given by J. Perrin in his book on "Atoms," translated by D. Ll. Hammick (Constable & Co., London), the diameters of various molecules, as below:—

Helium .. .. .	1.7 by 10 <sup>-8</sup> cm.
Argon .. .. .	2.8 "
Mercury .. .. .	2.9 "
Hydrogen .. .. .	2.1 "
Oxygen .. .. .	2.7 "
Nitrogen .. .. .	2.8 "
Chlorine .. .. .	4.1 "

The reader should note that the symbol 10<sup>-8</sup> means one divided by 100 millions, or 1/100,000,000.

It will be seen that the diameter lies between about 1½ and 4 Angström units, each of which is one hundred millionth of a centimeter. Since we know that Avogadro's constant is a number near to 66 × 10<sup>22</sup>, which is the number of molecules of gas in 22,400 cubic centimeters by volume, and since we know that this volume of hydrogen weighs 2 grams and of oxygen 16 grams, it follows that we know the absolute mass or so-called weight of a molecule of these gases; it is easy to find that the mass of an atom of hydrogen is near to 1.63 × 10<sup>-24</sup> gram, where 10<sup>-24</sup> means 1 divided by a billion times a billion. In other words, a billion times a billion atoms of hydrogen weigh 1.6 grams.

We know, therefore, the mass and diameter of various kinds of gas molecule and the number of them in a cubic centimeter at standard temperature and pressure. We have to realize that the molecules of the air we breathe are little particles of matter somewhere about a hundred-millionth of an inch in diameter, flying about in various directions with the velocity of a rifle bullet, or say, 1,500 feet or so per second, striking against other molecules about 5,000 million times in a second, moving on an average about four-millionths of an inch between each collision, and so numerous that about 400 million billion are contained in every cubic inch of space.\*

The pressure which the air exerts on the sides of a vessel containing it, which at ordinary barometric weight is about 14½ lbs. on the square inch, is due to the incessant bombardment of the inner surface of the containing vessel by these small but numerous projectiles.

Since the mass of an atom of hydrogen is 1.6 × 10<sup>-24</sup> gram and the diameter of a molecule (two atoms) of hydrogen is 2.1 × 10<sup>-8</sup> cm., it follows that the mean

\*In English reckoning a billion means a million times a million, or 1 followed by 12 cyphers, but in the United States a billion means 1,000 times a million or 1 followed by 9 cyphers.

density of a hydrogen atom is about 3.3 times that of water, and that of an oxygen atom about 51 times.

(To be continued in the next issue)

## Denmark's Laws Prevent Growth Of Radio

The Wireless Telephone has arrived in Denmark, according to Consul General Letcher. He reports to the Department of Commerce that it is hoped radio telephony, now that its advantages have been clearly demonstrated there, will soon leave the experimental stage and enter into practical service.

Experiments to acquaint the public with this modern means of communication began in August, with direct wireless communication between Copenhagen and a Scandinavian-American Line ship off the coast of Norway while en route to the United States. Recently the Danish Radio Company, which has installed nearly all the radio equipment on ships of that country, established radio-telephone communication between one of the Copenhagen telegraph news bureaus and Helsingør, about 30 miles away.

A delay in the natural development in the popular field has been caused through the fact that national laws forbid the use of all amateur radio telephone and telegraph apparatus. In spite of this law, however, there are said to be about 1,000 radio amateurs in Denmark. Several firms and institutions have succeeded in securing permission to operate for technical purposes. Nothing will be done to open the air to amateurs and public broadcasters, it is said, until after the International Radio Communications Conference meets in the spring.

Prospects for future developments in Denmark are believed to be good, if laws permitting the use of amateur apparatus are enacted.

## Broadcast Receiving and Receivers

(Continued from page 1627)

might go over a receiver and find surprisingly manifest evidence that wear and tear, rough usage, corrosion of joints, improper conductors and atmospheric effects bid well to bring the constants of the receiver down to a point where the resisted traverse of oscillations is becoming more and more detrimental to the tuning qualities, the receiving abilities, and the general usefulness of the receiver as a whole. Improper cir-

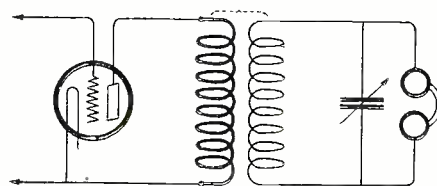

Fig. 4

Selection by an Auxiliary Circuit.

uits are the main offenders. Probably next comes wrong conductors. Then bad joints, especially those soldered with acid preparations to clean the soldered parts of all oxides.

The resistance of bad joints and improper conductors is often serious. Increase in the decrement is unavoidable if the latter is large. Only when the circuits have a decrement of .2 or less is the tuning ability satisfactory. This allows about 15 oscillations before the amplitude has fallen 10 per cent of the original amplitude.

The resistance of conductors is often unnoticed and unexpected. It is established that the effective resistance of a conductor

*Ask your dealer to show you the*  
**MAR-CO LINE of**  
**RADIO Products**

*Perfect in Design, Finish, and Workmanship*  
 MAR-CO Products are Electrically Correct

**Shur-Grip Plug \$1.50**

NICKEL FINISH. No tools necessary to connect. The Perfect Plug.

**MAR-CO W.D.11 Tube Socket 75c.**

Compact. Positive contact. Easy to mount.

**Sta-Put Plug 60c.**

Practical—Efficient—Reliable—No tools to connect.

**MAR-CO W.D.11 Tube Adapter 65c.**

An adapter that is electrically and mechanically perfect.

**MAR-CO Jacks 65c-\$1.10**

(Five styles). Open, Single, Double Circuit, Single and Double Filament. Control. Built to give a lifetime of service—Formica insulation.

**MAR-CO Pull Switch 90c.**

A simple practical battery switch. Only one hole necessary for panel mounting.

**MAR-CO Vernier Rheostat \$1.50**

Remarkably fine adjustment. Critical Filament easily controlled. 6 ohms resistance. 2 ampere capacity. Also very effective in use with WD11 Tube.

**MAR-CO Inductance Coils 40c-50c.**

Three sizes.

**MAR-CO Standard V. T. Socket 90c.**

A perfect reinforced bakelite socket—double contact.

**MAR-CO Tuner \$7.00**

A radical new development in tuning devices.

**MARTIN - COPELAND COMPANY**



Providence, R. I.



# The 1001st!

—but dealers will find it the first

**CORRECT!** The radio industry has been flooded with books and catalogs galore. Especially has the radio dealer been bombarded with his share. But now comes the thousand and first radio book, *that is, the first* which is both catalog and mentor to the dealer and public alike.

This book doesn't sell for five dollars, or fifty cents or one red cent. But to get it, friend reader, you must do one thing, and do it clearly and distinctly. If you will carefully extract your trusty Waterman from your inside vest pocket, give it a tentative shake, and print your name so our mailing department won't need to use a magnifying glass or a Sherlock Holmes to detect its significance, we will be glad to send you without one penny (red, blue or otherwise) your own individual and autographed copy of a catalog that is more than a atalog—a book that will prove your d viser and friend.

Within you will find illustrated and priced the most deservedly popular finished sets, construction sets and parts of such well known companies as Western Electric, De Forest, Acme, Sleeper, Murdock, Stromberg-Carlson, Marshall-Gerken, Atwater-Kent, Klosner, Dubilier, Briggs & Stratton, Thordarson and others.

Sign on the dotted line and Uncle Sam will do the rest.

THE NORTH AMERICAN RADIO & SUPPLY CORPORATION

5 Columbus Circle - New York City

Please send me that catalog you say so much about.

Name.....

Street.....

City.....

**GENUINE GERMAN MAUSER**



Latest model 9 shot automatic. Shoots standard cartridges—lies flat in pocket—World's famous Luger 30 cal. \$20.75 — Hand Ejector Revolver, swing out cylinder 32 cal. \$16.95. 38 cal. \$17.95. All brand new latest models. Guaranteed genuine imported. Pay on Delivery **SEND NO MONEY** Plus Postage

**\$6.95**

Satisfaction guaranteed or money promptly refunded. 25 cal. Pocket Automatic; 25 cal. Blue Steel Army Automatic \$8.45; 32 cal. \$10.45; Officer's Automatic, 3 safeties, 25 cal. \$11.95; Military Trench Automatic, 32 cal. 10 shot extra magazine FREE, \$11.65. Just like you used over there. Imported Top Brake Revolver, 32 cal. \$8.65; 38 cal. \$8.95.

Universal Sales Co. 141 B'way, Desk 282 New York

FREE

Complete price list of radio parts. Write Aitken Radio Co., 504 Superior St., Toledo, Ohio.

over between two collisions is called the mean free path.

In the case of air at normal pressure and temperature the mean free path is about 1/250,000th part of an inch or 1/10,000th part of a millimeter, or 1/10th of a micron. This is roughly about 500 times the diameter of a gas molecule. The mean free path varies inversely as the pressure of gas. Hence, if we make a so-called vacuum by removing all but one-millionth of the air from a vessel, the mean free path is increased to about four inches in length.

We can now give a more exact definition of what is meant by the diameter of an atom or molecule. It is the least distance between the centers of two atoms or molecules at their closest approach during a collision.

If  $D$  is the diameter of the sphere of impact or atomic diameter as defined above, and if  $N$  is Avogadro's constant or the number of molecules in a gram-molecule, and if  $V$  is the volume of this gram-molecule and  $L$  is the mean free path, then Clausius showed long ago that the relation between these quantities is given by the equation  $\pi \sqrt{2} LND^2 = V$  where  $\pi$  is the circular constant 3.1415....

From this equation we can obtain, as given by J. Perrin in his book on "Atoms," translated by D. Ll. Hammick (Constable & Co., London), the diameters of various molecules, as below:—

Helium .. .. .	1.7 by $10^{-8}$ cm.
Argon .. .. .	2.8 "
Mercury .. .. .	2.9 "
Hydrogen .. .. .	2.1 "
Oxygen .. .. .	2.7 "
Nitrogen .. .. .	2.8 "
Chlorine .. .. .	4.1 "

The reader should note that the symbol  $10^{-8}$  means one divided by 100 millions, or 1/100,000,000.

It will be seen that the diameter lies between about  $1\frac{1}{2}$  and 4 Angstrom units, each of which is one hundred millionth of a centimeter. Since we know that Avogadro's constant is a number near to  $66 \times 10^{22}$ , which is the number of molecules of gas in 22,400 cubic centimeters by volume, and since we know that this volume of hydrogen weighs 2 grams and of oxygen 16 grams, it follows that we know the absolute mass or so-called weight of a molecule of these gases; it is easy to find that the mass of an atom of hydrogen is near to  $1.63 \times 10^{-24}$  gram, where  $10^{-24}$  means 1 divided by a billion times a billion. In other words, a billion times a billion atoms of hydrogen weigh 1.6 grams.

We know, therefore, the mass and diameter of various kinds of gas molecule and the number of them in a cubic centimeter at standard temperature and pressure. We have to realize that the molecules of the air we breathe are little particles of matter somewhere about a hundred-millionth of an inch in diameter, flying about in various directions with the velocity of a rifle bullet, or say, 1,500 feet or so per second, striking against other molecules about 5,000 million times in a second, moving on an average about four-millionths of an inch between each collision, and so numerous that about 400 million billion are contained in every cubic inch of space.\*

The pressure which the air exerts on the sides of a vessel containing it, which at ordinary barometric weight is about  $14\frac{1}{2}$  lbs. on the square inch, is due to the incessant bombardment of the inner surface of the containing vessel by these small but numerous projectiles.

Since the mass of an atom of hydrogen is  $1.6 \times 10^{-24}$  gram and the diameter of a molecule (two atoms) of hydrogen is  $2.1 \times 10^{-8}$  cm., it follows that the mean

density of a hydrogen atom is about 3.3 times that of water, and that of an oxygen atom about 51 times.

(To be continued in the next issue)

## Denmark's Laws Prevent Growth Of Radio

The Wireless Telephone has arrived in Denmark, according to Consul General Letcher. He reports to the Department of Commerce that it is hoped radio telephony, now that its advantages have been clearly demonstrated there, will soon leave the experimental stage and enter into practical service.

Experiments to acquaint the public with this modern means of communication began in August, with direct wireless communication between Copenhagen and a Scandinavian-American Line ship off the coast of Norway while en route to the United States. Recently the Danish Radio Company, which has installed nearly all the radio equipment on ships of that country, established radio-telephone communication between one of the Copenhagen telegraph news bureaus and Helsingør, about 30 miles away.

A delay in the natural development in the popular field has been caused through the fact that national laws forbid the use of all amateur radio telephone and telegraph apparatus. In spite of this law, however, there are said to be about 1,000 radio amateurs in Denmark. Several firms and institutions have succeeded in securing permission to operate for technical purposes. Nothing will be done to open the air to amateurs and public broadcasters, it is said, until after the International Radio Communications Conference meets in the spring.

Prospects for future developments in Denmark are believed to be good, if laws permitting the use of amateur apparatus are enacted.

## Broadcast Receiving and Receivers

(Continued from page 1627)

might go over a receiver and find surprisingly manifest evidence that wear and tear, rough usage, corrosion of joints, improper conductors and atmospheric effects bid well to bring the constants of the receiver down to a point where the resisted traverse of oscillations is becoming more and more detrimental to the tuning qualities, the receiving abilities, and the general usefulness of the receiver as a whole. Improper cir-

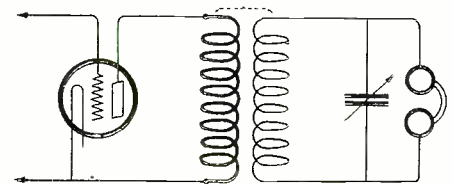

Fig 4

Selection by an Auxiliary Circuit.

cuits are the main offenders. Probably next comes wrong conductors. Then bad joints, especially those soldered with acid preparations to clean the soldered parts of all oxides.

The resistance of bad joints and improper conductors is often serious. Increase in the decrement is unavoidable if the latter is large. Only when the circuits have a decrement of .2 or less is the tuning ability satisfactory. This allows about 15 oscillations before the amplitude has fallen 10 per cent of the original amplitude.

The resistance of conductors is often unnoticed and unexpected. It is established that the effective resistance of a conductor

\*In English reckoning a billion means a million times a million, or 1 followed by 12 cyphers, but in the United States a billion means 1,000 times a million or 1 followed by 9 cyphers.

## Why the Electro-dynamic Principle is Best

TO own a good receiving set without Magnavox equipment, is like having your house properly wired and then using only small, feeble candle-power lamps in the sockets!

The Magnavox, in amplifying with extreme sensitiveness every signal supplied to it from the receiver, must necessarily amplify any extraneous sounds which may originate in the receiver or power amplifier itself.

Therefore, the combination of Magnavox Reproducer with Magnavox Power Amplifier (as illustrated) is very desirable. By this equipment, in connection with a good receiver, you get the music or speech with true clearness—and in practically any volume required.

The characteristic of the electro-dynamic principle involved in the construction of the Magnavox Reproducer is such that in operation, no distortional elements can possibly originate in the process of sound amplification.

As electrical engineers appreciate, the sensitivity of the movable coil in an electric field is of a far higher order than that which takes place in the ordinary electro-magnetic reproducer.



# This Combination Completes any RADIO RECEIVING SET



Whether placed in the average living room or large dance hall, Magnavox Radio floods the desired area with clear, resonant music or speech—its volume perfectly controlled from the Magnavox Power Amplifier constructed specially for it.

**Combination R-3 Reproducer and 2 stage Power Amplifier (as illustrated)**

**R-3 Magnavox Reproducer with 14-inch curvex horn: ideal for homes, offices, etc.**

**R-2 Magnavox Reproducer with 18-inch horn: the utmost in amplifying power, for store demonstration, large audiences, dance halls, etc.**

**Model C Magnavox Power Amplifier insures getting the largest possible power input for your Magnavox Reproducer**

Magnavox Products can be had of good dealers everywhere  
**The Magnavox Co., Oakland, California**  
 New York: 370 Seventh Avenue

Write for booklet illustrating and describing the

# MAGNAVOX Radio



## The ideal battery for low voltage tubes

The Storage Battery Magno is ideal for the new low-voltage tubes. It is the most economical battery made—costing much less than dry cells to operate.

The Magno is recharged by unscrewing cover and inserting "spare" electrode. "Spares" are exchangeable at your dealers or direct from our factory at 25c each. Each "spare" will give you many times more hours of service than will a dry cell. Keep a spare charge on hand and your concert will never be interrupted. Learn more about this remarkable storage battery.

Write today for descriptive folder R-1-3

Dealers write for lists

*"Every Battery Its Own Service Station."*  
MAGNO STORAGE BATTERY CORPORATION

AEOLIAN BLDG. NEW YORK

# STORAGE BATTERY MAGNO

Our moulded variometer and other moulded products will mean satisfied customers and more sales to you Mr. Jobber & Dealer, why not write to us for full particulars?

**The RIDgewood RADio Shop**  
1603 Myrtle Ave., Ridgewood, L. I.

Amateurs we rewind and repair fones; send them to us

### Hit it anywhere!

Radio Crystal will revolutionize the Receiving set—making it possible to obtain results heretofore unknown to users of other Crystals. Minerals or Substances—Guaranteed to be the WORLD'S super-sensitive Radio Detector Crystal. Unaffected by handling or moisture. Service indefinitely. Price 50 cents at your DEALER or mailed direct postpaid. Owners and National Distributors—  
**GIBBONS-DUSTIN RADIO MANUFACTURING CO.**  
618 W. 9th St. Los Angeles, Cal.

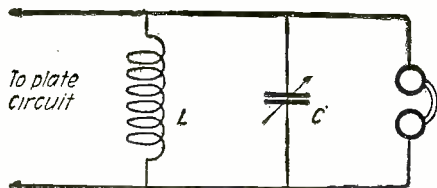

Fig. 5

Note Selector for Heterodyned Signals.

traversed by high frequencies depends upon the frequency, therefore the wavelength. The resistance to a longer wave is generally less for a given conductor than that for a shorter wave, because of the difference in the frequency. High frequency currents mainly travel on the surface. In order for them to reach below the surface time must be allowed. It is manifest that in a circuit, say receiving a 300 meter wave, the actual sinking of the energy below the surface is small in amount or effect but in receiving a lower frequency, corresponding to a longer wave, there is more time allowed for the current to sink below the surface and enlist the further conductivity of the inner particles of the conductor. For instance at a frequency of 1,000,000 cycles (300 meters) the current may only traverse the conductor below the surface to an extent of .0025 inch. At a lower frequency the depth reached is greater due to the time element.

The above may seem hairsplitting but for best results it is not. If we do not properly take into account the actual agents which bar our receivers from selectivity and low damping we may as well go back to the coherer and popoff's lightning rod. If nothing better, we may be able to ascertain that in most cases QRM and extraordinarily unnecessary and constant static interferences are in part due to the inefficiency of our receivers rather than to the contrary.

The way the situation now stands in the radio field is this: Congestion is rampant. Interference is great. Stations are numerous and their sparks and sustained waves are intermingled, blanketing, interfering, heterodyning, and often powerful. There is no happy medium in receiving, especially with the use of an out-door aerial. The way is pointed exclusively to loop and other directional receiving antennae.

However, for those who insist on the out-door antennae, the above points have been reviewed, as they have been lately many times over.

When the old rockcrusher across the way comes roaring in like a ton of lead pigs, go over your receiver on a critical and conscientious survey and try to discover if your receiver is correct. The results may be surprising.

## Radio in Denmark

From our Berlin Correspondent

PLANS have been made for using radio in Denmark for a large variety of purposes, a big radio company in Copenhagen, in conjunction with the Danish Telegraph Department and the Great Northern Telegraph Company, being engaged not only in providing wireless communication with other countries, but in installing radiotelephones throughout Denmark. One high power central station and two medium sized stations are to be erected. The new company will be granted exclusive rights for the spreading of radio information of public interest, weather and trade and stock exchange bulletins, as well as miscellaneous news. The apparatus required for this service is exclusively manufactured by that company, the receiver placed at the disposal of every subscriber costing only 20-30 kroner.



## Designed! Not just "made"

The market is over-run with head phones. Some are "made to sell"—others designed to perform a service—a service measured in terms of sensitiveness, tone quality, clarity—phone efficiency. Such is the Basco Radio Head Phone—built first for service. Deep, natural-voice pitch—keenly sensitive—clear, scratchless. Coils encased in aluminum—light weight—easy on the head. Light diaphragm set to thousands-of-an-inch accuracy form magnet poles. Horseshoe type magnet. See your dealer.

Dealers and Jobbers: Write for particulars on our complete line of parts.

**Briggs & Stratton Co.**  
Milwaukee PRODUCT Wisconsin

GET AN  
**F.R.S.**  
Long Distance  
Single Bulb  
RECEIVER  
**\$17.50**



RESPONDS to wave lengths up to 600 meters. All molded Panels, Dials and Sockets. Has Variocoupler and "Read 'Em" Binding Posts, Rheostat and Rotary Switch, complete. Fine Mahogany Cabinet with Phone Compartment. May be hooked up in any standard circuit. Pin a Money Order to this ad, mail it today and you will be all set to enjoy the wonderful programs broadcasted every day.

**FOR \$40**

we will send you the F. R. S. Complete Two-Stage Long Range Receiver, including Cabinet—ready to hook up. A \$125 value!  
Batteries, Tubes and Phones extra  
**F. R. S. RADIO CORPORATION**  
409 E. E. Fort St., Detroit, Mich.

**KEEP  
A DAY AHEAD**

of the headlines of tomorrow's newspapers!

Don't be satisfied with the regular broadcasted programs! Get the most out of radio! Hundreds of radio enthusiasts are doing it!

Equip your vacuum tube set with a  
**FINCH RADIO RELAY**

and you will automatically receive and at the same time have a permanent record of all the important and interesting news events of the world, whether or not you know the code.

Send Today for Booklet R3

**FINCH RADIO MFG. CO.**  
303 FIFTH AVE. N.Y. CITY.

**THORO-BRED RADIO PRODUCTS**  
The Marshall-Gerkin Co.  
Toledo, Ohio



# PACENT JACKS

REDUCE  
INTERNAL NOISES

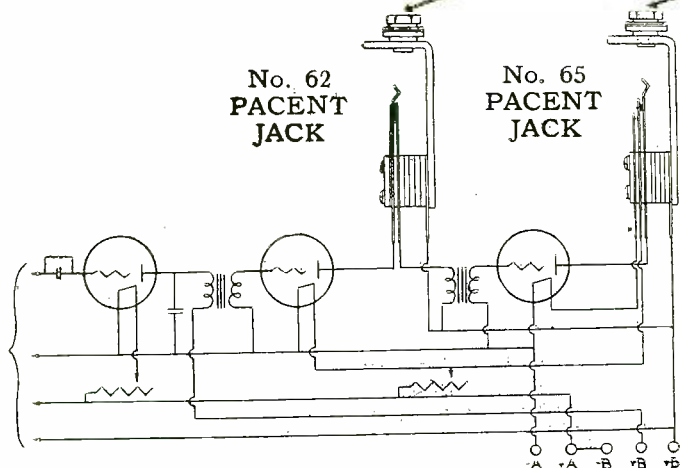
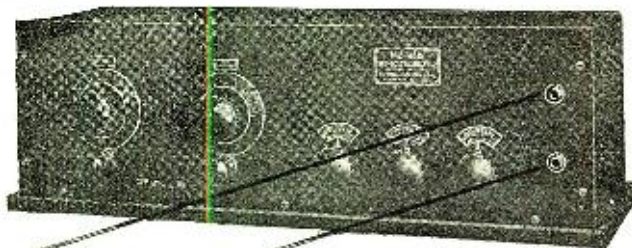

The MU-RAD R. F. Receiver shown using three stages of Radio Frequency Amplification and two stages of Audio Frequency Amplification is equipped with PACENT Jacks.

The diagram shows the wiring of the Audio Frequency Circuit and the jack equipment.

Where extremely high amplification is employed, it is vital that the construction insulation and contacts of the jacks should be perfect. Hissing or crackling in circuits greatly reduces the range of a receiver. MU-RAD Sets with PACENT Jacks are remarkably free from internal noise.

PACENT Radio Essentials by virtue of their excellent quality and thorough dependability are the choice of leading set manufacturers and radio engineers. They embody the highest type of radio engineering skill and over fifteen years practical radio experience.

*Don't Improvise—"PACENTIZE"*

Look for the Pacent Trade Mark. It is your guarantee of **QUALITY ACCURACY** and **DEPENDABILITY** in Radio Essentials

*Write for Descriptive Bulletins N-3*

## PACENT ELECTRIC COMPANY

INCORPORATED

Manufacturers and Distributors of Radio and Electrical Essentials  
Executive Offices: 22 Park Place, New York, N. Y.

BRANCH OFFICES

Philadelphia, Bourse Building  
Chicago, 53 So. Clinton Street  
St. Louis, 704 Pontiac Bldg.

Members Radio Section, Associated Mfrs. of Electrical Supplies



Washington, D. C., Munsey Bldg.  
San Francisco, Sheldon Bldg.  
Minneapolis, 827½ Nicollet Avenue

Canadian and British Licensees:  
COLONIAL RADIO, Ltd., Hamilton, Canada

# R - A - D - I - O

## At Cut Prices

New York is the center of Low Prices on Radio Merchandise.  
We are New York's Leading Retailer and can offer you the opportunity to buy from us at New York prices.

All our goods are guaranteed to be of First Quality.  
We ship anywhere on day order reaches us.

Here is a wonderful chance to procure the well-known Proco Tube Set at a price which is far below the manufacturing cost. This set has accomplished some remarkable long-distance reception. Don't miss this opportunity!

RECEIVER AND DETECTOR TYPE R-D	DETECTOR AND 2 STAGE AMPLIFIER TYPE D-2	RECEIVER DETECTOR 2 STAGE AMPLIFIER TYPE R-D-2
Wave length 150 to 600 meters. Of the best construction.	This instrument is a revelation of efficiency. Best that can be made.	Simple of operation. Gives most satisfying results.
Regular price .....\$42.00	Regular price .....\$55.00	Regular price .....\$85.00
<b>OUR PRICE .....\$20.95</b>	<b>OUR PRICE .....\$23.95</b>	<b>OUR PRICE .....\$41.50</b>

HEAD SETS		TUBES	
Regular	NOW	Regular	NOW
\$6.50 Turney 3000 ohms	\$ 3.75	\$5.00 U. V. 200	\$3.90
\$7.50 Turney 57 3000 ohms	4.95	\$8.50 U. V. 201	4.90
\$7.50 Stromberg-Carlson	4.95	\$8.00 U. V. 202	5.95
\$6.00 Baldwin "Master" Single	4.95	\$8.50 W. D. 11	5.25
\$12.00 Baldwin "Master" Double	9.75	\$5.00 C. 300	4.10
\$8.00 Brandes Superior	5.95	\$8.50 C. 301	5.10
\$25.00 Browns Adjustable	14.00	\$12.00 Y. T. 2	8.00
\$23.00 Brown Plain	12.00	\$3.00 Meyer	4.75

VARIABLE CONDENSERS		TUNING APPARATUS	
Regular	NOW	Regular	NOW
\$3.85 Capacity .001	\$1.95	\$8.00 Arrow Variometers	\$3.75
\$3.50 Capacity .0005	1.65	\$8.00 Liberty Variometers	2.65
\$4.75 43 Plate (Madam X)	1.95	\$6.25 H & H Moulded Variometers	3.95
\$3.75 23 Plate (Liberty)	1.25	\$6.00 Arrow Variocouplers	2.75
\$2.00 3 Plate (U. S. Tool)	1.25	\$9.00 All Wave 3000 Meters	7.95

MISCELLANEOUS	
\$2.25 Branch Crystal Detectors	\$1.25
\$1.25 Liberty Crystal Detectors	.50
\$1.00 Arkay Crystal Detectors	.35
\$4.00 Two Slide Tuning Coil	2.45
\$3.50 Two Slide Tuning Coil	1.95
\$2.00 Potentiometers	1.75
\$1.00 DeForest Sockets	.85
\$ .25 Solderall	\$ .19
\$ .75 Fada Rheostats	.45
\$1.50 Klossner Rheostats	.65
\$1.85 Reeps Rheostats	1.35
\$1.25 Amco with Dial	.95
Buss Wire per foot	.02
Bell Wire 1/2 lb.	.25

We pay mailing charges on orders of \$3.00 and over. For amounts less than this add 25c for mailing.

# LIBERTY RADIO CO.

106 LIBERTY STREET, NEW YORK CITY, N. Y.

## LEARN THE CODE AT HOME

"Just Listen—The Omnigraph will do the teaching"

with the

### OMNIGRAPH

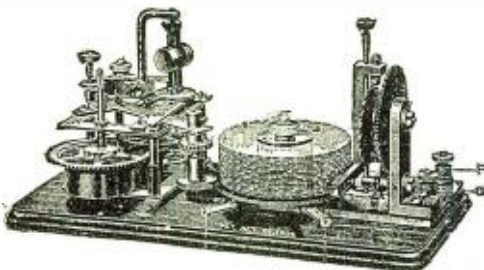

THE OMNIGRAPH Automatic Transmitter will teach you both the Wireless and Morse Codes—right in your own home—quickly, easily and inexpensively. Connected with Buzzer, Buzzer and Phone or to Sounder, it will send you unlimited messages, at any speed, from 5 to 50 words a minute.

THE OMNIGRAPH is not an experiment. For more than 15 years, it has been sold all over the world with a money back guarantee. The OMNIGRAPH is used by several Depts. of the U.S. Govt.

—in fact, the Dept. of Commerce uses the OMNIGRAPH to test all applicants applying for a Radio license. The OMNIGRAPH has been successfully adopted by the leading Universities, Colleges and Radio Schools.

Send for FREE Catalog describing three models, \$14 to \$30. DO IT TODAY.

**The Omnigraph Mfg. Co., 20 Hudson St., New York City**

If you own a Radio Phone set and don't know the code—you are missing most of the fun

## The Principles and Construction of an Electrolytic Rectifier

(Continued from page 1643.)

ever, a rectifier of this type will be useful about the home and laboratory wherever an alternating current is available, and a direct current of low amperage is wanted. It would be ideal for charging storage batteries of 60 ampere-hour capacity, or less, and for experimental work.

Four jars are necessary. These may be of glass, metal, or glazed earthenware. It is evident that the greater the exposed surface, the greater will be the cooling facilities, so bear this in mind when making your selection. Procure jars that are as large as convenient. A good size is about five inches in diameter and six inches deep. If you use metal you should cover the interior surface with several coats of pitch or asphaltum varnish. A dull black paint or pigment applied to the exterior will increase its heat radiation surprisingly.

Procure your metal sheeting, and if you intend using jars of the size mentioned, cut

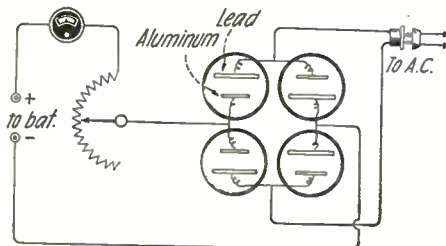

Fig. 5

Circuit Diagram of the Complete Rectifier Outfit.

four strips of lead about four inches wide and six inches long, and four strips of aluminum about three inches wide and also six inches long. This metal stock should be at least one-sixteenth of an inch thick. Thicker material has the good quality of giving longer service. If you intend to use jars of a size different from that mentioned, make the plates and other fittings in proportion. If your metal is very thin the cutting can be done with a pair of tinners shears, but the thicker metal may have to be cut with a hack saw. It is imperative that you use the purest aluminum obtainable, for otherwise the rectifier will not function properly. If you have some old lead pipe around, that is between an inch and an inch and a half in diameter, you can use this in place of the lead sheeting. Simply cut off a six inch length, slit one side parallel to its axis, and flatten it out.

Next cut four discs of well seasoned wood, or some other insulating substance, about six inches in diameter. These discs can either be turned out on a lathe, or cut by the more laborious method of the scroll saw. Bend over one end of each of the lead and aluminum strips, about a half inch down, at an angle of 90 degrees. Fasten the strips to the discs by means of a screw and a binding post through each lug, as shown in Fig. 2. A lead and an aluminum plate goes on each disc. Space the plates about an inch and a quarter, and be sure that they are rigid. It is well to drill a hole in the center of each cover to allow the gases to escape. Paint the exposed metal parts above the electrolyte with the asphaltum varnish to prevent corrosion.

The electrolyte to be used is a saturated solution of ammonium phosphate in as pure water as it is possible to obtain. The chemical must also be pure. To make a saturated

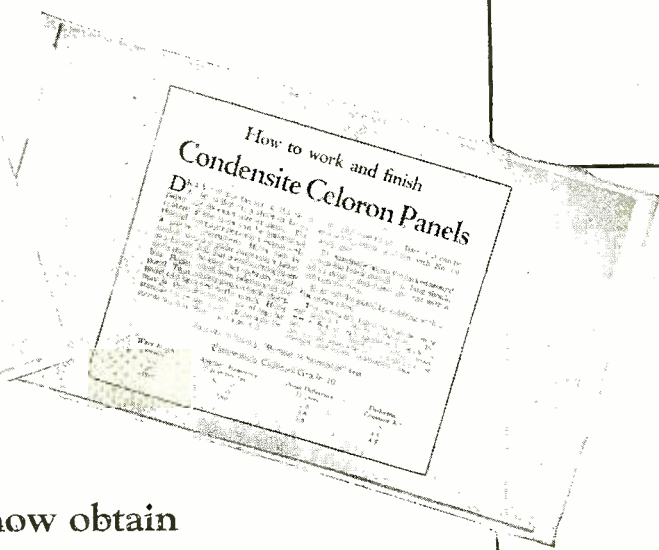
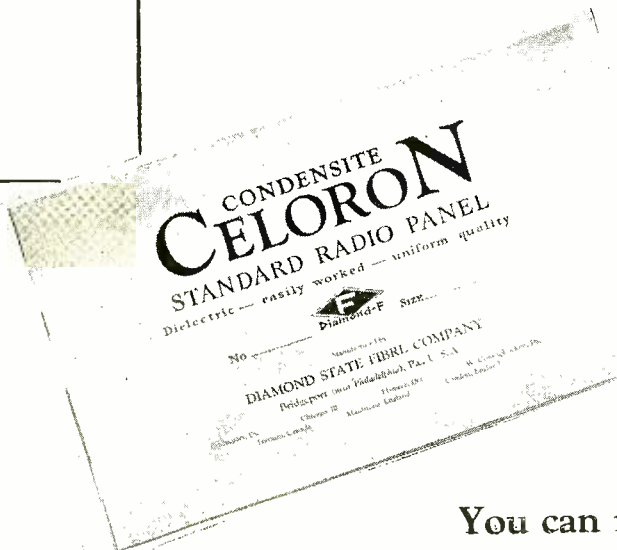

You can now obtain

# Condensite Celoron Radio Panels

cut in standard sizes

**Y**OU can now get radio panels already cut to a size to fit your needs. For your convenience we are making Condensite Celoron Radio Panels in seven standard sizes. No longer will you have to wait and pay extra cost for having your panel cut to order.

These sizes have been so designed as to meet practically every need of the set-builder. Each panel comes trimmed and wrapped separately in glassine paper to protect the surface. They are all ready for immediate use. On every one are full instructions for working and finishing.

**What Condensite Celoron Is**  
Condensite Celoron is a laminated phenolic condensation product used by many of the leading manufac-

turers of radio equipment. It has high insulation resistance, high dielectric strength, low dielectric losses and is easily worked. Because Celoron has these qualities it has received the approval of the U. S. Navy Department Bureau of Engineering and the U. S. Signal Corps.

You can obtain any of these seven standard sizes:

- 1. — 6 x 7 x 1/4
- 2. — 7 x 9 x 1/4
- 3. — 7 x 12 x 1/4
- 4. — 7 x 18 x 3/16
- 5. — 9 x 14 x 3/16
- 6. — 7 x 21 x 3/16
- 7. — 12 x 14 x 3/16

Select the size you need for your set. If your radio dealer has not yet stocked them, ask him to order for you. Or write direct to us, designating by number the size you want. We can make prompt shipment.

To radio dealers: Write for special dealer price list showing standard assortments

**Diamond State Fibre Company**  
BRIDGEPORT (near Philadelphia) PENNSYLVANIA

BRANCH FACTORIES AND WAREHOUSES  
BOSTON CHICAGO SAN FRANCISCO  
Offices in Principal Cities

In Canada: Diamond State Fibre Company of Canada, Limited, Toronto

# CONDENSITE CELORON

## STANDARD RADIO PANEL

# What about RADIO in 1925



## Can You Keep Pace With Its Progress?

FAR fetched, indeed, would it be for any publisher to claim that a book on RADIO published *to-day* can also be an authority TO-MORROW, in 1924, and in 1925, for who can foretell what great changes will mark the progress of RADIO before it attains its final state of development? LEFAX, however, has gone very far to attain just such a goal by publishing in loose-leaf form an authoritative book on RADIO and then supplementing this information each month with *additional* pages that keep pace with the rapid developments of RADIO science.

### The One Best Book on RADIO

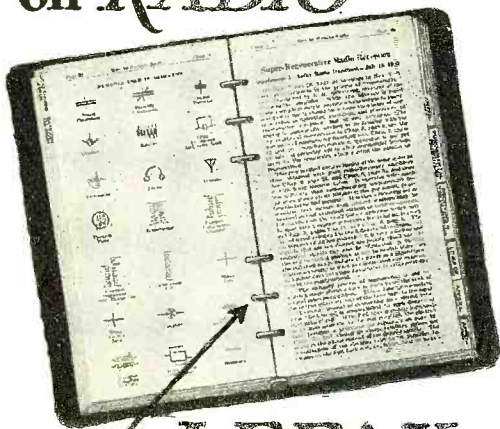

**LEFAX**  
*Never Grows Old*

### Four Big Features

**Never Grows Old**—About once a month additional pages are sent out to purchasers of the book, thus keeping it perpetually up-to-date.

**Eminent Authors**—The book, as well as the supplementary service, is written by the two chiefs of the Radio Laboratory, U. S. BUREAU OF STANDARDS, Dr. J. H. Dollinger, and Mr. E. L. Whittemore.

**Stations List and Apparatus Section**—Contains a list of broadcasting stations, which is kept continuously revised. Also contains a section devoted to apparatus, which is continuously supplemented by new pages.

**Neat and Convenient**—Finest imitation morocco leather binder, nickel plated "snap-back" rings—chapters separated by handy linen index tabs.

**\$3.50**

For sale at all Radio Dealers—  
Dept. Stores—Book Stores and  
Principal Stationers

Lefax, Inc. 147 S. 9th St.  
Phila., PA.

solution it is fairly safe to allow a pound of the phosphate to a gallon of water. Stir it until it is thoroughly dissolved, and see that no sediment remains at the bottom. A mineral oil, such as paraffin oil, can be floated on the surface of the solution in the jars to help prevent evaporation, and also prevent sparking at the surface of the liquid. This latter, although pretty to look upon, causes a rapid deterioration of the plate at the point of occurrence.

A tray is next in the order of construction. Make this of the form shown, and of well seasoned wood, from a half to seven-eighths of an inch thick. Allow enough space for the four jars, with a slight separation between them to admit a circulation of air.

The panel can be made of marble, bakelite, or even hard wood, and should be of the width of the tray and of a height depending upon the size and number of instruments that you intend to use on it; the arrangement in the drawing being only suggestive. It can be fastened to the tray with screws along the bottom, or small brackets can be used at the sides. If it is made of wood, paint it with shellac or some other insulating varnish.

The instruments shown include an ammeter, a rheostat, and two double pole knife switches. The switches can be fused to take care of a possible short circuit or other accident. The meter will indicate the amount of current that is allowed to pass into the battery by the rheostat. One of the switches is connected on the input, or A.C., side, and the other is connected on the direct current output side. The rheostat should be designed to adequately handle five amperes at 100 volts. Binding posts can be mounted on the D.C., and a flush connection plug on the A.C. side of the apparatus.

Now you can make the necessary connections. Use number 14 or 16 rubber covered wire for this purpose. Before connecting permanently, you must "form" the aluminum plates. Otherwise, when first connected up, the rectifier will have the effect of short circuiting the line. You can do this forming process by connecting the rheostat and the ammeter in series with the A.C. leads and the rectifier, the jars being arranged as they are in the diagram. Leave the D.C. leads open. Cut in a fairly large amount of resistance and turn on the "juice." A current will flow at first, but will gradually die down to almost zero. Now cut out some of the resistance. A rise in current will take place, but this current will also gradually die down. Keep up this process until all the resistance of the rheostat has been cut out of the circuit, and the rectifier refuses to pass any appreciable current. When this condition is reached, the plates have been formed, and the rectifier is ready to be connected up in the manner shown in the diagram. Be sure and get the right polarity connection on your meter. This can best be determined by experiment. A reversed polarity will tend to move the indicating arrow backward. The lead from the aluminum plates, on the output side, is positive. It is best to mark this near the output binding posts, to avoid mistakes.

The outfit is now ready for service, and if you have followed instructions carefully it will give *good* service. The only cause for poor results is faulty construction, or the use of impure aluminum or ammonium phosphate. Add water from time to time to make up for that lost by evaporation. If excessive heating is experienced you should cut in more resistance, thereby lowering the current. Three or four amperes can be de-

## Ozburn-Abston Radio Co., Inc.

600-612 Monroe Ave., Memphis, Tenn.

RADIO PRODUCTS OF MERIT

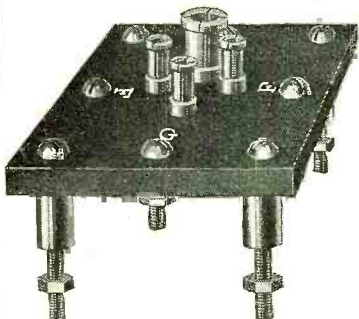

Positive contact socket for the one and one-half volt Aeriotron WD-11 tube. No loose or oxidized spring contacts, consequently no tube noises. Cat. No. B-2.  
Price ..... \$1.25



MINIATURE JACKS  
for all uses

For standard tube prongs or for use with Miniature Plug. Cat. No. C-100. Price, 11¢ For Phone Tips. Cat. No. C-101. Price 11¢ For large prong of WD-11 tube or 50 watt tube. Cat. No. C-102. Price ..... 16¢



An Adapter for the Aeriotron WD-11 tube. Fits any standard socket. No wiring changes necessary, merely insert Adapter and substitute dry cell for 6 volt storage battery. Cat. No. 0-1. Price.....\$1.40



Miniature Plug made of polished bakelite and nickel metal parts. Used to replace binding posts where quick, positive action is desired. Cat. No. C-1. Price, 25¢

# BARKELEW

For simplicity of design, good appearance and low cost these connectors are in a class by themselves. By means of one or the other you can attach from one to four head sets to any type of radio receiving set. On all of them the phone tips enter from the front and therefore do not increase the diameter, which with all tips adjusted is but 1 1/4 inches.

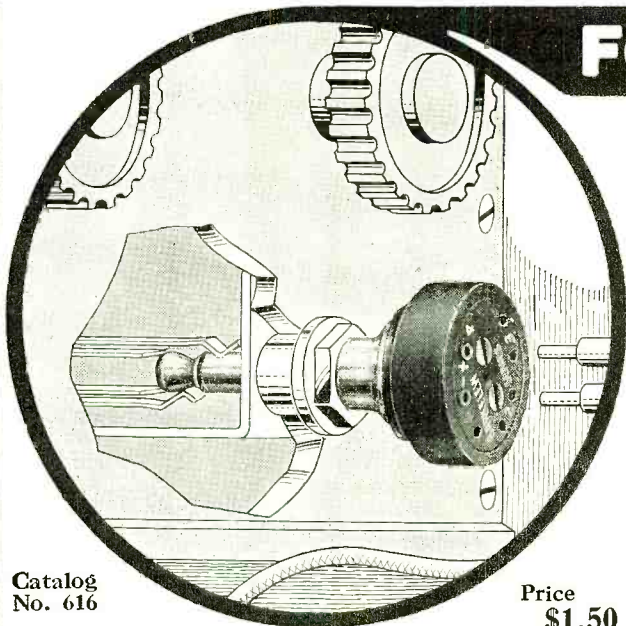

## FOUR-PHONE PLUG

This Improved Four Phone Plug with series connection and insulated case will connect four phones or less to any set employing telephone jacks.

The holes with bosses are the terminals of the Plug. For one head set use these holes only. For more than one head set start with one bossed hole and use the holes consecutively but always carry the last phone tip back to the other bossed hole. For four phones all holes will be used.

There is ample room for all the phone tips and they can be adjusted without removing the plug. The tips are held by a special spring contact which we have developed for this purpose.

Catalog No. 616

Price \$1.50

## FOUR-PHONE POST *for* CRYSTAL and ONE TUBE SETS

These posts are built for panel mounting but not necessarily limited to this type. They are adaptable to any home made set. They replace or may be hooked in multiple with regular phone binding posts.



Cat. No. 618

Price 75c

The Barkelew Four Phone Post for use with one tube set. Series Connection

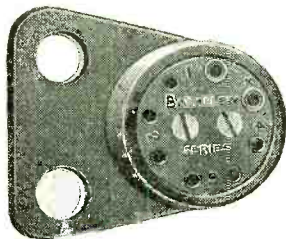

Cat. No. 617

Price \$1.00

This Four Phone Post is especially adapted for Ariola Senior. Series Connection



Cat. No. 615

Price 75c

The Barkelew Four Phone Post designed for use with crystal set. Multiple Connection

### To Radio Distributors and Dealers

Trade discounts to Radio Distributors and Dealers who have established standing or can prove their status.

Write for our new Window Display Cards featuring our Four-Phone Plug. Bulletins No. 27, No. 28, No. 29, and No. 30, showing these and other Radio apparatus will be furnished on request.

Try your dealer; if he cannot furnish, write nearest office for name of one who will.

## The Barkelew Electric Mfg. Co.

MIDDLETOWN, OHIO

15 S. Clinton St., Chicago  
75 Fremont St., San Francisco  
411 Main St., Los Angeles

603 Century Bldg., Pittsburgh  
1487 Broadway, New York  
Denham Bldg., Denver



Different tubes require different capacities. State when ordering, exactly what tube fuses are for.

## Impossible!

**E**VEN if you try deliberately you **CANNOT**, with any ordinary "A" or "B" current (or both) "blow out" the filament of a Vacuum Tube protected by the

# RADECO SAFETY FUSE

(Patent Pending)

Designed to laboratory standard of accuracy, and applied directly upon the filament terminal where no excess current whatever, even an accidental short, can get by it, the RADECO Safety Fuse is invariably positive in its action, affording **ABSOLUTE PROTECTION**.

A special process of making assures absolute uniformity.

**In standard packages of 4 for \$1**

Special Fuse for WD11 . . . . . 50c each

At your Dealers—or by Mail

**CAUTION:**

*Do not force fuse on filament terminals. If contact solder is rough, file or sand-paper down so that fuse slips on easily. Filament terminals are the two farthest from the locking projection on base of tube.*

WD11 ADAPTERS--make WD11 tubes fit standard sockets.....\$1.50

## RADIO EQUIPMENT CO.

630 Washington Street Boston, Mass.

*New England's Oldest Exclusive Radio House*

livered for many hours at a time without undue heating. With larger jars, or with a special cooling arrangement, greater amounts of current can be successfully passed.

### Mr. Bimberry Hears the Banquet

(Continued from page 1637)

"This is WPX, Rahway, New Jersey, broadcasting the Monks' Club Banquet from the Grand Ball Room of the Hotel Vastor, New York City; AKG announcing," said the voice. "I am situated in the balcony opposite the speakers' table and can see everything that is going on. At present nothing is going on. I presume the guests are arriving in the large reception room adjacent to the grand ball room. I can't see them from here. The banquet promises to be a very elegant affair. The tables are set with china and glass, and there are flowers on them. It is very attractive. From here I can count thirty-seven waiters—"

"Isn't it wonderful?" exclaimed Mr. Murchison. "It is just as if we were there!"

"Another waiter had just entered," announced AKG. "I presume he has been in the kitchen seeing that all is ready. From here the scene is very attractive. Some of the waiters are moving about and some are standing in one place. I presume the guests are now arriving in large numbers in the reception room. A waiter has just brought in a plate of oysters. He seems surprised; I presume he thought it was time for the oysters. He is taking the oysters out again now. This is WPX, Rahway, New Jersey, broadcasting the Monks' Club Banquet from the Grand Ball Room of the Hotel Vastor, New York City, AKG announcing."

"When does Kade begin?" asked Mr. Bimberry.

"Pretty soon," said Mr. Murchison. "Just wait."

"I'm waiting, ain't I?" asked Mr. Bimberry, just a little irritably.

"This," said the voice in the horn suddenly, "is WPX, Rahway, New Jersey, broadcasting the Monks' Club Banquet from the Grand Ball—"

"What does he say that for?" demanded Mr. Bimberry. "He said that before, I know that already. What I want to hear is George Kade—"

"Shush!" whispered Mr. Murchison; "he's going ahead!"

"AKG announcing," said the voice in the horn. "The waiter who brought in the oysters and took them out again has just come in again. He has a plate of soup. He is looking around the ball room and he seems surprised. I think he is a new waiter. I don't think he has been employed here long. He has light hair. I think he is a Swede, but he may be a Swiss. Possibly his father was a Swede and his mother a Swiss. The head waiter is speaking to him now. The waiter seems to be saying, 'Here is some soup; what shall I do with this soup?' I cannot hear what the head waiter is saying to him in reply. I am in the balcony opposite the speakers' table and the waiter is at the far end of the room. I presume the head waiter is saying to him, 'What do I care what you do with the soup? It's not my soup.' The waiter seems to be perplexed. He seems to be thinking, 'I brought a plate of soup to this banquet and there isn't any banquet yet. What should a waiter do with a plate of soup when there is no banquet?' Or he may be thinking of his parents. He may be thinking: 'What would my Swiss mother and my Swedish father do with a plate of soup if they brought it from the kitchen to a banquet of the Monks' Club

## "ILLINOIS" THE RELIABLE

### CONDENSER THAT IS MADE RIGHT AND STAYS RIGHT

	Panel	Cased		Panel	Cased
67 Plates.....	\$7.00	\$8.50	23 Plates.....	\$2.75	\$4.00
43 Plates.....	3.50	4.75	13 Plates.....	2.25	3.50

Vernier with single movable plate applied to 13, 23 or 43 sizes, \$2.00 extra. Above list is for our Regular Style with Knob, Pointer and Scale. We also furnish the Condenser with smooth 3-16 inch staff suitable for Dial at 15c off list.

A 3-inch Bakelite Dial with Condenser, add 50c to list.

Fully Assembled and Tested. **IMMEDIATE SHIPMENT.**

Money back if not satisfied. Just return within 10 days by insured Parcel Post. Sent Prepaid on Receipt of Price, Except: Pacific States, Alaska, Hawaii, Philippines and Canal Zone, add 10c. Canada, add 25c.

No Discounts except 5 per cent on orders of 6 or more. Send for Bulletin.

## G. F. JOHNSON, 625 Black Ave., Springfield, Ill.

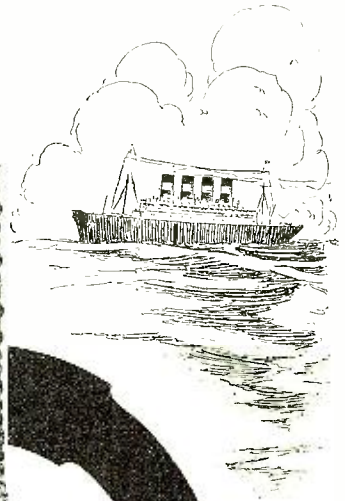
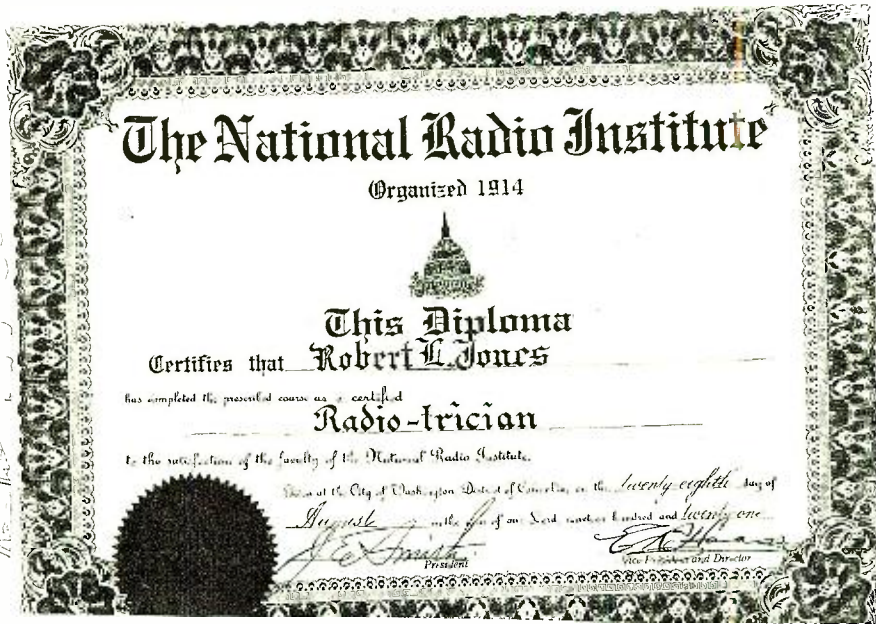
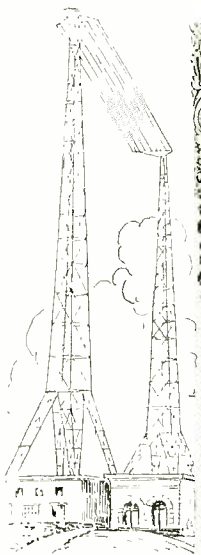

# This Certificate Opens the Way to the Best Radio Positions

## Get It - You Can Earn Big Money With It

No previous experience in electricity or Radio is necessary. In a few short months, you can easily win this certificate and qualify for one of the splendid, big money positions in Radio.

Edwin L. Powell is an Expert Radio Aid at the Washington Navy Yard and earns Big Money. Leo Goldblatt is earning a Big Salary and all expenses paid as a radio operator. James F. Nicholls is earning \$150 a month and all expenses as a radio instructor at Walter Reed Government Hospital. Harry Ruck has made big money manufacturing radio sets. Hundreds of other men are occupying equally attractive positions after winning our Certified Radio-trician certificate.

Read in the panel of the fine salaries paid in all the wonderful radio positions for which you can qualify once you have this certificate.

### Easy Now to Become A Certified Radio-trician

No other work in the world today offers such opportunities, such big money, such rapid advancement, such a promising future as does Radio. And the Expert Radio-trician is the man who is in a position to choose the best of these opportunities—to jump farthest ahead in this newest and fastest growing industry.

Become an Expert Radio-trician. You can—easily and quickly. The National Radio Institute, America's first and largest Radio School, has devised a remarkable method that makes it easy for anyone to qualify right at home during spare time. Prominent radio experts give you personal advice and instruction through the mail. They grade your papers, answer your questions, and in every possible way help you in your work. And you learn the practical, wonderful side of radio by actual practice on patented instruments we send you free. The Certified Radio-trician Certificate awarded you

on the completion of your course is government recognized, counting for 5 to 10 points on all government license examinations.

**Pick Out The Job You Want And We Will Help You Get it.**

This is a brief list of the positions in the Radio field today, and the salaries paid.

- Radio Mechanic, \$1,500 to \$2,000 a year.
- Radio Inspector, \$1,800 to \$3,000 a year.
- Radio Auditor, \$1,200 to \$1,800 a year.
- Radio Salesman, \$2,000 to \$5,000 a year.
- Radio Engineer, \$3,500 a year and up.
- Radio Executive, up to \$10,000 a year.
- Radio Aid, \$6 to \$10 a day.
- Radio Draftsman, \$7 to \$10 a day.
- First Class Ship Operator, \$105 a month, all expenses paid.
- Commercial Land Station Operator, \$150 a month and up.
- Broadcasting Station Operator, \$125 to \$250 a month.

**WARNING!**

Ours is the one complete Course that prepares you for a first class government license. It is complete in every detail. Necessary practice instruments are supplied free. Don't be confused by cheaper or free courses. They cannot secure for you a government license which is necessary to obtain a good position in Radio.

### Four Radio Instruments Free

An extraordinary feature of this course is the use of four patented instruments, owned exclusively by us, which give practical training in radio operation, installation, maintenance and repair—all of which you must have to become an Expert Radio-trician.

Among these instruments is the wonderful Natrometer, said by experts to be the perfect device for teaching the Radio Code. All of these instruments are given free during the course.

### Send For Free Radio Book

Thousands of positions are open to Certified Radio-tricians. Find out what your opportunities are in this fascinating profession. Send for interesting free book, "How to Learn Radio at Home," which gives complete details on plan by which the National Radio Institute quickly qualifies you at home in spare time as a Certified Radio-trician. Send the coupon or a postcard for free book NOW.

### NATIONAL RADIO INSTITUTE

Dept. 13-C  
1345 Pennsylvania Ave., N. W., Washington, D. C.

NATIONAL RADIO INSTITUTE,  
Dept. 13-C 1345 Pennsylvania Ave., Washington, D. C.

Send me your free book, "How to Learn Radio at Home," with full particulars about the opportunities in radio, and how you will quickly train me in my spare time at home to win a Certified Radio-trician Certificate. Also tell me how your free Employment Service will help me to a position.

Name ..... Age .....

Street .....

City ..... State .....

## We Are Manufacturers of Fine Radio Furniture

A Radio Desk De Luxe—the last word in Radio Furniture. A place in which to lock up your Cabinet. A drawer with lock, for your tubes, headset, etc. A Cabinet for concealing storage battery, "B" batteries and rectifier. A broad place on top for loud-speaker.

### SPECIFICATIONS

Hardwood, rubbed mahogany or dark golden-oak finish. Roll top with lock. Height over all, 40 inches. Upper Cabinet: 12x12x22 inches. Drawer: 17x9x2 inches. Battery Cabinet: 21x14x13 inches.

### PRICES

Express paid east of Mississippi River.....\$25.00  
Express paid west to Rocky Mt. States..... 27.50  
Express paid to Rocky Mt. and Pacific States.. 30.00

### CASH WITH ORDER

#### RADIO TABLES

Handsome Hardwood, hand rubbed, mahogany or golden-oak finish. Drawer with lock, for headset, tubes, etc. (by error not shown in cut.) Ample space for Cabinet on table. Plenty of space for concealing all batteries and rectifier. A beautiful piece of furniture for the home.

Shipped, charges paid, to points east of Mississippi River, west of Mississippi River, add \$1.00 to either size.

14¾x24x26 inches high.....\$12.00  
16½x26x26 inches high..... 15.00

### CASH WITH ORDER

#### RADIO CABINETS

Hardwood, hand rubbed, mahogany finish. Hinged top, front rabbeted for panel. Sent postpaid.

**THE SOUTHERN TOY COMPANY**  
HICKORY, NORTH CAROLINA



in the Grand Ball Room of the Vastor Hotel, New York City, AKG announcing for Broadcasting Station, WPX, Rahway, New Jersey.

"What is he talking about soup for?" demanded Mr. Bimberry gruffly. "I didn't want to hear about soup."

"I know," said Mr. Murchison, "but until the guests assemble—"

"What I came here for was to hear George Kade make a speech—"

"Shush!" whispered Mr. Murchison. "It's coming now!"

And, indeed, the voice in the horn did speak with fresh and more cheerful vigor. The voice seemed more hopeful and optimistic.

"This," it announced, "is WPX, Rahway, New Jersey, broadcasting the Monks' Club Banquet from the Grand Ball Room of the Hotel Vastor, New York City, AKG announcing. Somebody just came in at the other door," it continued apologetically, "and I thought it was the guests arriving, but it was only the waiter—the Swiss-Swede waiter. He has a plate of fried fish in his hand and he seems surprised. I presume he thinks he has lost the banquet and thought if he tried another door he might find it. From here he seems to be looking at the plate of fried fish reproachfully. Perhaps he is dropping a tear on it. Perhaps he is thinking of his dear old Swiss mother and how she would worry if she knew he was all alone in a great city with a plate of fried fish and no banquet to give it to. Now he is looking at the ceiling, but there is no ladder and he cannot put the fried fish on the ceiling. Now he is turning. He has gone out of the Grand Ball Room of the Hotel Vastor, New York City, AKG announcing—no, hold on! it isn't time to say that yet! This is WPX, Rahway—no, it isn't time to say that yet! I am situated on the balcony opposite—no, I did say that! I presume the guests are arriving in the—no, I said that before! The banquet promises to be a very elegant affair—no, I said that! The tables are set with china and—no, I said that once! One minute, please!"

In the silence that ensued Mr. Bimberry scowled at Mr. Murchison.

"Murchison," he growled, "you coaxed me here to hear George Kade make a speech—"

"Well, you're going to hear him, ain't you?" cried Mr. Murchison. "Just be patient a minute, can't you? I can't go out into that reception room and drag George Kade into the Ball Room and make him talk, can I? Be a little patient, Bimberry, for heaven's sake and—shush! shush! Now we get the speech!"

"This," said the voice in the horn firmly, as if it meant to be trifled with no longer, "is WPX, Rahway, New Jersey. We are broadcasting the Monks' Banquet from the Grand Ball Room of the Hotel Vastor, New York City. This is AKG announcing. There seems to have been some slight delay in the arrival of the guests, but I believe the banquet is now going to begin. A gentleman in full evening clothes, including a white tie, open front vest, split-tail coat and black pants with braid down the seams has just entered the Grand Ball Room hastily, closing the door behind him. It is Oleander P. McGuffin, Chairman of the Annual Banquet Committee of the Monks' Club, and he has a red badge with gold fringe on the lapel of his coat. He is the author of the successful play Polly from Paris and the top of his bald head seems to be perspiring freely. He stands near the door and seems to be casting his eye over the room to see that all is in order. Now he is frowning. He sees something protruding from beneath the cloth of Table No. 21. He is stooping to pick it up. It is black and shaped like a shoe. It is a shoe. There seems to be a man in the shoe. Mr. McGuffin is holding

## BELL MOULDED BAKELITE RADIO PARTS

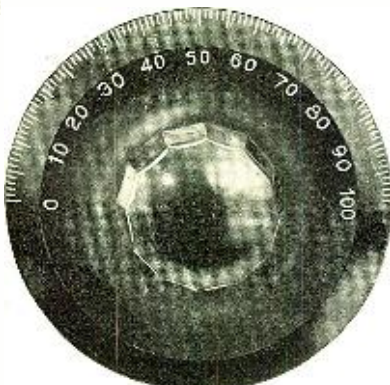

Price, 75c.

Genuine Bakelite highly polished. Fine clear cut graduations and numerals. Knurled knob fits fingers perfectly and allows fine adjustment. No corners to catch dust. Moulded stops—Runs true. 3½ in. Dial.

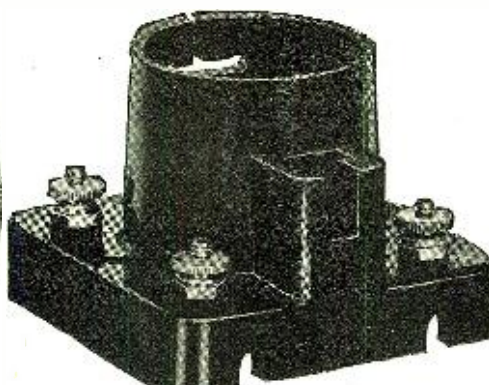

Price, \$1.00

Genuine Bakelite. Heavily nickeled phosphor bronze springs designed to make double electrical contact. Adapted for panel or base mounting. Reinforced T slot allowing use of sending or receiving tubes without adjustment.

Attractive Discounts to the Trade

Manufacturers of Moulded Insulation since 1911

**BELL MANUFACTURING CO., 14 Elkins St., BOSTON, MASS.**

HAVE YOU SOMETHING TO SELL OR EXCHANGE?

A classified ad in Radio News will reach over 225,000 at a cost of only fifteen cents a word.



# The New Bradleystat - a Phenomenal Success

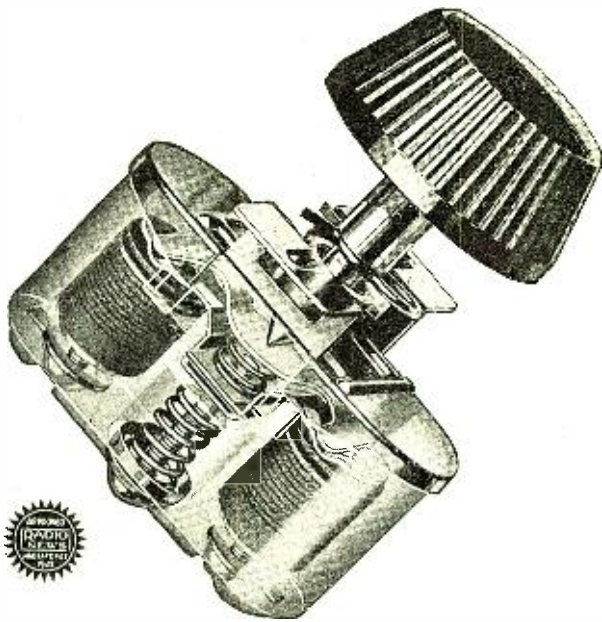

## A Phantom View, Showing the Discs

These graphite discs, scientifically prepared, contain the secret of the Bradleystat. No wire rheostat can possibly give the noiseless, smooth control so eagerly sought by radio men. For both 6-volt and 1½-volt tubes, Bradleystat control is unsurpassed.

The discs have no inductance. They last forever, and laboratory tests reveal that they maintain better adjustment than the wire rheostat. Try one, tonight, and enjoy the supreme delight of Perfect Filament Control.

**Allen-Bradley Co.**  
Electric Controlling Apparatus

287 Greenfield Avenue • Milwaukee, Wisconsin

Member of the National Radio Chamber of Commerce

## Some Distinctive Features

The new Bradleystat is creating widespread interest among radio enthusiasts. Several refinements in the new model makes the new Bradleystat pre-eminent in the field of filament rheostats.



The new knob, beautifully proportioned and fluted to match the finest radio equipment, distinguishes the new Bradleystat for its splendid appearance. The new porcelain container is smaller than the older model, but the range of control is better than ever.

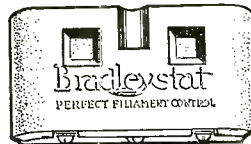

The name, "Bradleystat" is embossed on the new container to protect you against spurious imitations. Safeguard your radio set by insisting on genuine Bradleystats. An adjusting screw has been added in the base for setting the "cut-off" switch as you desire.

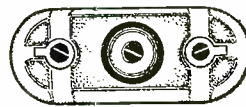

Retail Price

**\$1.85**

P. P. 10c extra

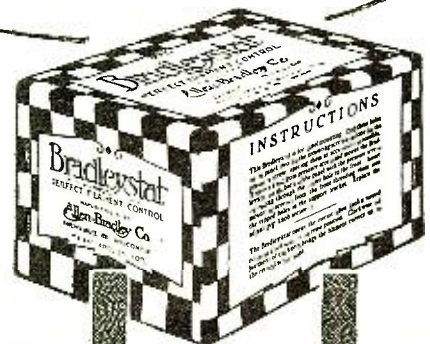

# Bradleystat

REGISTERED U. S. PAT. OFF.

## PERFECT FILAMENT CONTROL

**Radio Catalogue FREE**

One copy of this complete Catalogue of Radio Outfits, parts, Dictionary of Radio Terms, Instruction Book, and Guide to Successful Radio Work—one copy is yours Free.

Simply write us a post card and we will mail the complete book to you Free, by return mail.

It quotes the lowest prices, amazingly low prices on everything for the expert and the amateur. Every improved part, the most up-to-date outfits, everything that is needed of the most modern type—at the lowest possible prices.

It gives a list of broadcasting stations, and gives much information about radio construction and operation. Every one interested in Radio needs this complete catalogue and book of instruction.

**Why Pay Higher Prices?**

Montgomery Ward & Co. has for fifty years dealt on a Money-Back basis, absolutely guaranteeing everything they sell. With quality absolutely assured, why pay higher prices elsewhere? Write today for this Free Radio Book and see for yourself the Saving it will bring you. One copy is yours Free. You need only write us a post card.

**Write to the house nearest you. Address Dept. 2-R**  
Chicago Kansas City St. Paul Fort Worth Portland, Ore.

# Montgomery Ward & Co.

== The Oldest Mail Order House is Today the Most Progressive ==

**The "SATURN AUTOMATIC" RADIO PLUG \$1.50**

*The More You Pull  
The Better the Contact*

No more taking apart to make connections. Just insert the terminals into the Saturn and a perfect contact is made. So constructed that pulling on the cords makes the connection more positive. Let your customers try this test themselves. It will convince them that the Saturn "Automatic" is far superior to any plug on the market. Instantaneous Disconnection just by touching this lever! Every plug is sealed and fully guaranteed.

**THE SATURN PERFECT JACK**

This Jack is an improvement on all other Jacks on the market. The crowfoot offset allows easy soldering. The bracket is made of Brass, Nickel Plated; rounded corners. The Blades are of Spring German Silver. The Contact Points are Genuine Silver. The Nipples are shoulder type and are furnished with two washers, Nickel Plated and Polished.

Single Circuit Open.....	\$0.65	Double Circuit Closed.....	\$0.90
Single Circuit Closed.....	0.75	Single Filament Control.....	1.00

Double Filament Control, \$1.25

Write for catalog and discounts. Amateurs: If dealer cannot supply, order direct

**THE SATURN MFG. & SALES CO., INC.**  
48 Beekman Street Dept. R. N. New York City

the shoe and motioning to the head waiter. The head waiter is now approaching Mr. McGuffin. They are pulling the shoe, and drawing a man from beneath the table. The man appears to have been hiding under the table. It is a waiter. He has a plate of sliced roast beef, medium rare, in his hands. He is saying something to Mr. McGuffin but I cannot hear what he is saying. I presume he is saying, 'Here is the roast beef; where is the banquet?' The head waiter seems to be saying, 'I have nothing to do with the roast beef; it is nothing in my young life.' Mr. McGuffin seems to be perplexed. Now he has taken the plate of roast beef. This is WPX, Rahway, New Jersey. Mr. McGuffin is walking toward the platform where the band is to sit. We are broadcasting the Monks' Club Banquet from the Grand Ball Room of the Hotel Vastor. The band has just entered and taken its seats. This is AKG announcing. Mr. McGuffin is looking for a place to put the plate of roast beef. This is WPX, Rahway, New Jersey. He sees the large saxophone of the largest saxophonist. We are broadcasting the Monks' Club Banquet from the Grand Ball Room of the Hotel Vastor. Mr. McGuffin has just emptied the plate of roast beef into the mouth of the large saxophone. AKG announcing. The large saxophonist has picked up the saxophone and is going to play—One minute please!"

"Look here, Murchison," said Mr. Bimberry, angrily; "I came here to hear George Kade speak—"

"Oh, cut it out, Bimberry!" cried Mr. Murchison, really quite irritated. "You're going to hear George Kade speak! There's always some of this sort of thing first; they've got to amuse us while the guests are arriving and the dinner is being served and eaten. Be reasonable, can't you? You're seeing the whole banquet; it's just as if you were there, isn't it? Don't you fret—you'll hear George Kade all right. Give us a chance, can't you?"

So Mr. Bimberry, none too graciously, settled back in his chair and gave them a chance. Again and again the large horn announced that it was WPX, and that it was Rahway, New Jersey, and that it was AKG announcing. It said the banqueteers were entering the Grand Ball Room, and that it was a lovely scene, and that the ladies were superbly gowned, and that the men were in conventional black. It said the oysters were being served, and that the noise now heard was not static but the diners eating their soup. Mouthful by mouthful Mr. Bimberry and Mr. Murchison's wife followed the banquet through course after course, and were told that the waiters were now leaving the room, and that the president of the Club was introducing the Toastmaster. They heard the President introduce the Toastmaster. Mr. Bimberry was now looking at his watch every minute.

"And I have the pleasure," said the voice of the Toastmaster, "to introduce to you the man who has made all America laugh, Mr. George Kade, our most celebrated humorist. Ladies and gentlemen, Mr. Kade!"

"A—h!" breathed Mr. Bimberry in a long sigh of relief and satisfaction, but at that moment the pleasant voice of AKG broke in, saying:

"We will now have an intermission of ten minutes for the retransmission of Arlington time signals and the Weather Reports for New York and New Jersey, after which—"

But there was no "after which" for Mr. Bimberry. He gave one glance at his watch, jumped for his suitcase, and let the door slam behind him as he leaped down the front steps and sprinted for his train.

**CAN'T RE-FUSE THIS JOKE!**

Professor—"What do you use a fuse for?"  
Student—"To burn out."

# New Radio Products Manhattan Made



The Red Seal Radio Sparker, for Operating WD-11 Tubes.

A special dry battery that lasts nearly 3 times longer

Radio Sparkers Made in 3 Sizes

No. 221—2 cell	\$1.00
No. 262—6 cell	3.10
No. 282—8 cell	4.00

F.o.b. factories

IF you have been attaching a single dry cell to each WD-11 tube, there's a better way. The new Red Seal Radio Sparker gives longer service. For example, the two-cell Radio Sparker No. 221, designed to operate one WD-11 tube will last, not twice as long, but 2½ to 3 times as long as a single cell.

Radio Sparkers are a complete unit, light in weight and easily handled. All internal connections between cells are soldered within the convenient container and the famous Manhattan Spring Clip Connectors insure a quick, bulldog grip with your receiving set. The labels of all Radio Sparkers contain simple diagrams and complete instructions for the "hook up."

For long life, economical operation and satisfactory results use Red Seal Radio Sparkers with WD-11 tubes.

This battery is the product of the oldest and largest national distributor of radio, also makers of the line of famous Red Seal batteries for over 30 years.

Progressive dealers everywhere carry "Red Seal Radio Sparkers" and "Manhattan" radio products. You want the best. Ask your favorite dealer for them by name. If he hasn't them, he will get them for you.

## The New Manhattan Genuine Bakelite Dials, Variocoupler and Variometer

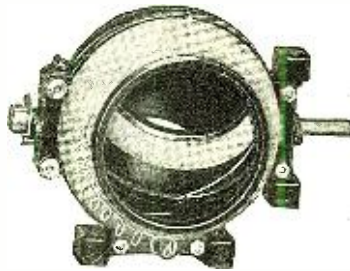

Manhattan Variocoupler

The primary winding of the Manhattan Variocoupler is provided with 12 taps,—giving complete control up to a wave length of 700 meters. (List price \$6.50)

Both instruments are provided with heavy braided "pigtaills," making connection with the rotating member. This insures positive contact and quiet operation. Sufficient friction is provided to permit easy turning of the rotor and just sufficient binding to have it stay put in the position desired. A strong stop limits its movements to 180 degrees.

The stator of both variometer and variocoupler is provided with a ¼ inch collar, permitting the attachment of a standard 3 inch bakelite tube for constructing the familiar "long wave" coupler.

BOTH the Variocoupler and Variometer are made of moulded, genuine reddish brown bakelite and have that fine attention to detail, so much sought after by the critical buyer.

The amount of metal used in the instrument has been reduced to a minimum to keep the electrical losses as low as possible. Variometers and variocouplers are frequently mounted on "shielded" panels. Realizing this fact, we have provided a bakelite mounting block permitting the use of the variometer and variocoupler on a metal panel, thus eliminating all insulation difficulties. These are two distinctive features of Manhattan Variometers and Variocouplers.

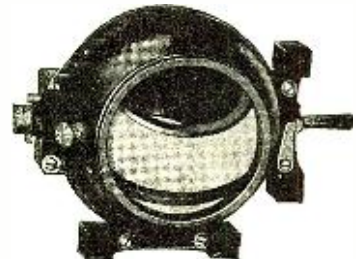

Manhattan Variometer

The Manhattan Variometer, as commonly connected in a receiving set, has a wave length of 140 to 420 meters. (List price \$6.50.)



Manhattan Bakelite Dials

## Manhattan Bakelite Dials

The Manhattan line of genuine non-warping bakelite dials will appeal to those who desire precision and quality. The brass bushings for the shaft are accurately centered and insure perfect alignment. The engraving on the dials is extremely fine and clear. Manhattan Bakelite dials are made in 2", 3" and 4" diameters for both 3/16" and ¼" shafts and list at 60c, 75c and \$1.35 respectively.

**MANHATTAN**  
ELECTRICAL SUPPLY CO., INC.  
Makers of the famous Red Seal Dry Batteries, Radio Sparkers  
and Manhattan Radio Products

New York

Chicago

St. Louis

San Francisco

Plants: Jersey City, N. J., Ravenna, Ohio.

# WONDERFUL RESULTS!

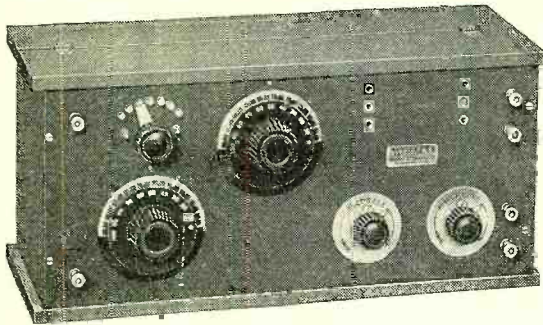

That's what users say they get with **MIRACO RADIO FREQUENCY RECEIVING SETS.** Reception from Broadcasting Stations over

1500 miles distant is easy under average conditions. Price, \$29.50

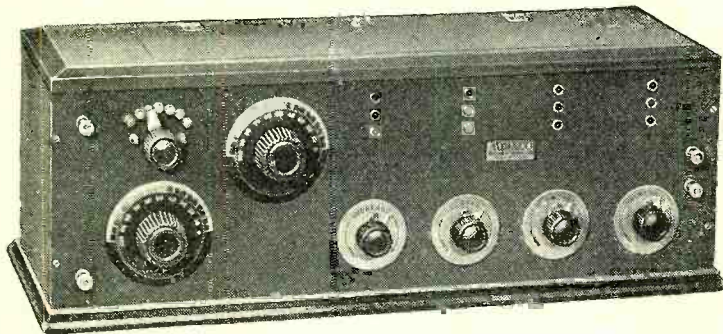

One of the outstanding features of the various types of MIRACO sets is that they may be used with either *WD11 tubes* and a 1½ volt dry cell to light all tubes or Radiotron tubes and a 6 volt storage battery. In ordering be sure to specify which tubes are to be used. Bulletin on request. Price \$54.50. A Money-Making Proposition for Dealers.

*Agents wanted everywhere.*

## THE MIDWEST RADIO CO.

804 Main Street

Cincinnati, Ohio

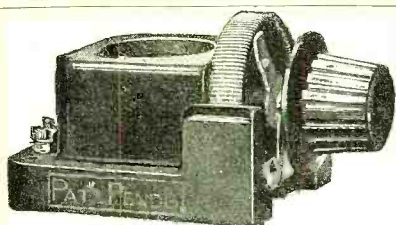

### KING RHEO-SOCKET

Price \$3.00, f. o. b., N. Y. C.

This rheostat embodies compact, increased efficiency, having shorter connections and less wiring. It will bring in stations you have never heard before. Make this King Rheo-Socket a part of your up-to-date set. A high-grade article in red bakelite with phosphor-bronze contacts and alloy resistance wire.

For base or panel mounting

**KING AM-PLI-TONE**

82 Church St., New York City

Mfrs. of the famous King Am-pli-tone

Jobbers:

Wire or write for interesting proposition.

### Panel Service

We offer to the amateur and dealer **Real Panel Service.** Our panels are cut to your order. Only genuine Bakelite or Formica used.

1/8"	per square inch	.02
3/16"	" " "	.02½
1/4"	" " "	.03

We also carry a full line of radio essentials. Dealers will find it profitable to have our latest price list and discount sheet.

**PITTSBURGH RADIO AND APPLIANCE CO., INC.**

*"Pittsburgh's Radio Shop"*

DESK A

112 Diamond St., Pittsburgh, Pa.

## Formulae

By JOHN D. FORREST

(Continued from January Issue)

Connecting 500 volts to the filament of your receiving tubes generally always accomplishes surprising results. The exact space current between the plate and the counterpoise cannot be figured by formula. However, the experiment is highly interesting, especially when you watch another doing it, yet is quite expensive at such times as when the filaments burn out, which may possibly occur when 500 volts are connected to them. A formula which is greatly in error, but at least comparative, is as follows: Divide the number of old bachelors in heaven by the cross section of the worn out rails on the N. Y., N. H. & H. R. R. and the result will be the number of hen's teeth found in the Brontosaurus, a dependable approximation, in rough estimates.

Amplification is a bogie to many hams. My system, if followed strictly to the letter (and to the poorhouse), will be highly satisfactory to the alienist's office. Dissolve three nice new megohms in a litre of saponified hydroxide of mosquito tails. Powder down to a fine state with mortar and pestle. If you are a Mason this will be particularly easy. Pour the solution about the vacuum tubes in your cabinet, and after carefully concealing yourself in the neighborhood, catch a bevy of active young electrons. The green ones are best for this purpose. Sprinkle them lightly along the antenna lead in and lie in wait for the appearance of a signal. When the signal arrives it will see the electrons, and, contrary to practice, the signal will rush down toward the electrons to form a current. Quickly jerk away the electrons, by a string tied previously around their necks, and the signal will be carried by its great momentum into the tube, where it will slop over the plate circuits and probably run down all over the floor in some cases, which is more than expectations generally expect, and which is the desired result. Repeat this 693,277 times per kilowatt hour and you will then be ready for the alienist's official badge of recognition. It is time to state here that the plate current circuit breakers should be set for 600 amperes, because anything in excess of that figure may burn out the condensers shunting the upper binding post.

Thin copper sheets about 1/8" thick make good strong panels for amplifiers and regenerative vario-loose couplers. When signals are received over sets employing these, the results are astounding. They are so easily machined. I generally do this with my teeth, although I broke several of the panels before the hang of the thing came to me, and then, too, one must use care in working the panels down to size in this manner. Unsightly tooth marks in the copper may be erased by applying a solution of gum arabic held in suspension in sulphuric acid by means of a small manila rope.

To ascertain the wave-length of the average amateur antenna the best method is as follows: Carefully select one of the outgoing waves, making sure that you are securely hidden behind a magnetic screen. When the wave starts out across country, just trip out and follow it about for a few days. The result will be easily found if you keep up with it. This method is much simpler than by measuring with the spaghetti meter, which has a fundamental error of 43½ tons to the square milliamp.

If the reader heeds these simple instructions from the simple mind of a simple-  
(Continued on page 1693)

Insure your copy reaching you each month. Subscribe to Radio News—\$2.50 a year. Experimenter Publishing Co., 53 Park Place, N. Y. C.

# The Radio Guild, Inc.

## R G 510

The New Radio Guild Radio-Audio Frequency Complete Receiver of Unequalled Excellence and Efficiency

The R. G. 510 is the "distance" receiver you have been looking for. With the small loop aerial supplied with each set it is just as easy to pick up stations a thousand miles away as the nearby stations. The operation is simplicity

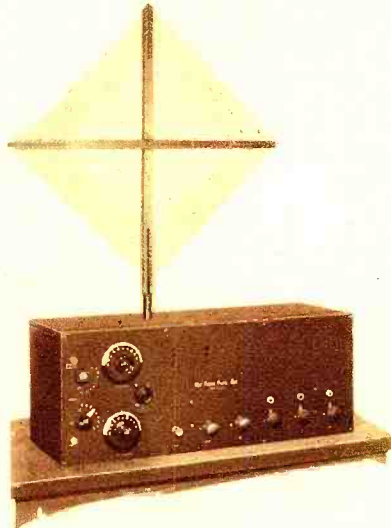

itself. Designed by experts in radio frequency amplification. Provision is made for reception with an outside aerial and ground if desired. A loose-coupled circuit is employed to ensure selectivity. Operates on one, two or three stages of audio frequency amplification. Reproduction is suitable for the home or loud enough to fill an auditorium. Material and workmanship of the highest quality.

List Price ..... \$195.00

Dealers: Write for discounts



**APPROVED RADIO NEWS MAGAZINE 1923**

The Radio Guild  
**"MULTI-RANGE" COUPLER**  
 Single layer and bank wound.  
 Wave length range 150-3400 meters.  
 List price, \$11.00      Dealers: Write for discounts.

### A THOUSAND MILES EVERY NIGHT ON THE LOOP!

## Read the New Harkness Book

### on Super-Regeneration

48 pages, 30 photographs, wiring diagrams, mechanical drawings.

Explanation of the theory of super-regeneration is a revelation.

Send for your copy today. Price 50c.

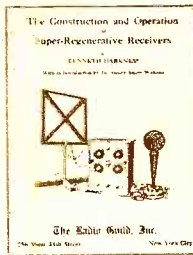

## The Radio Guild, Inc.

256 W. 34th Street

Specialists in radio frequency amplification.

New York, N. Y.

Designers and manufacturers of the "Vox Humana" the "Broadcast Receiver" and the "Dashboard Special."

Distributors of DX Radio Frequency Transformers

# BUILD YOUR SET WITH BARAWIK STANDARD

## PLATE CIRCUIT "B" BATTERIES



You can make real savings on these batteries. Don't pay more. We guarantee them to equal any on the market regardless of price. Absolutely uniform. Extra long life.

- E180 Signal Corps type, small size, 15 cells, 22 1/2 volts. Each... 95c
- E184 Variable Large Navy size, 6 1/2 x 3 inches 5 tabs, giving range from 10 1/2 to 22 1/2 volts in 1 1/2 volt steps. Each... \$1.80
- E188 Combination Tapped 45 volts 30 cell, E184X battery. Tapped to give 45, 22 1/2, 21, 19 1/2, 18 and 16 1/2 volts. Handles both detector and amplifier tubes. Each... \$3.55

## WILLARD "B" STORAGE BATTERY

Better results. No battery noises. Cheaper in the long run. Easily recharged by our Battery Charging Rectifier. Leak proof glass jars. Will last for years.

- E205 Price... \$9.00

## HOMECHARGER BATTERY CHARGING RECTIFIER

Charge your battery at home over night for a few cents. Simply connect to any 110 volt 60 cycle light socket, turn on current and rectifier does the rest automatically. Will work for years without attention. Simple connections. Gives a tapering charge which batteries should have. You can make it pay a profit charging your friends' auto batteries. Long connecting cords with pair of battery clips.

- E201 For 6 volt battery... \$13.95
- E203 For 12 volt battery... 13.95

## STORAGE "A" BATTERY

A very high grade battery made for radio service. Guaranteed for three years. Properly cared for will give many more years of service for filament lighting. Made of best new materials. Full capacity. The best battery buy on the market. Try one of these batteries on your set for 10 days. If at the end of that time you are not fully satisfied with the battery return it and we will refund the purchase price.

- E194 6 volt, 40 ampere size. Each... \$10.00
- E196 6 volt, 80 ampere size. Each... 12.50

## BATTERY CLIPS

E198 Two for... 28c  
E199 One for... 14c

## WIRE CONNECTING CLIPS

E199 Per dozen... 30c  
Small connecting clips for electrically fastening leads onto binding posts, etc. Handy and useful. Every radioist should have at least a dozen.

## PORCELAIN BASE SWITCHES

E387 Single Pole Double Throw. Each... 32c  
E384 Double Pole Double Throw. Each... 50c

## FILAMENT CONTROL RHEOSTATS

E130 Each... 45c  
E132 Each... 45c

## POTENTIOMETER

E133 Each... 98c

## VERNIER RHEOSTAT

E135 Each... 75c

## QUICK ACTING VERNIER RHEOSTAT

E124 Each... \$1.19

## PORCELAIN BASE RHEOSTAT for table mounting.

E136 Each... 75c

## KLOSNER VERNIER RHEOSTAT

E129 Each... 83c  
Regular \$1.50 value. Limited quantity at this price.

## RADIO TUBES

- E350 Diameter 3 inches, per foot... 20c
- E351 Diameter 3 1/2 inches, per foot... 25c
- E352 Diameter 4 inches, per foot... 30c

## WE PAY TRANSPORTATION CHARGES EAST OF THE ROCKIES

THE PRICES QUOTED DELIVER THE GOODS TO YOUR DOOR  
FAST SERVICE—TRY US AND BE CONVINCED

THIS GUARANTEE PROTECTS YOU—Examine the goods we ship you. They must suit you in every respect. If you are not satisfied with your purchase return the goods at once and we will refund the price you paid.

## AGENT-DEALERS WANTED

We want Agent-Dealers in every locality to handle our line of goods. Our Proposition Means Money to You  
Our prices save you money. The quality of our goods insures satisfied customers. Our service will help you do a large business on a small investment. SEND FOR OUR CATALOG

We have selected a line of goods—both completed sets and parts to assemble sets—that will enable you to supply every demand and make money. You can make a good income on our proposition with a very small investment. Our catalog shows the merchandise you should handle, gives much radio information and will help you establish a successful business. Enclose 10c for the catalog. Tell us what you can and want to do, and how much you can invest. We'll do the rest.

## For the Person Who Makes His Own Set

Our catalog is interesting and valuable. Even if you are not interested in radio as a business you will find many interesting things in this catalog and you will save money buying your supplies from us.

## VACUUM TUBES

Standard Brands—Cunningham Radiotrons. Every one guaranteed new and perfect. We will ship brand in stock unless you specify otherwise.

- E105 Detector, UV300 C300 Ea. \$4.45
- E110 Amplifier, UV301 C501 Ea. \$5.95
- E118 3 Watt Transmitter, 7.20
- E107 WD11 1 1/2 v. Fil. Each... 1.75
- E108 WD11 Socket. Each... 49c
- E109 WD11 Adapter. Each... 48c

## MYERS TUBES

Can be used in Myers receptacle or in any standard socket with adapter listed.

- E113 High-Mu Audion. Has 5 times amplification of ordinary tubes. Oscillates anywhere from 2 to 300 volts on plate. We include our best grade rheostat with each tube. Each including rheostat... \$5.00
- E116 Receptacle for above. Each... 1.00
- E117 Adapter to adapt Myers tubes for use in any standard socket. Each... \$1.05

## MYERS CHOKE COIL

Designed to work with Myers tubes. Brings in loudest signals. Flexible over a broad band of wave lengths. Free from amplifier noise and distortion. Mounts in Myers special receptacle.

- E119 For Audio Frequency Amplification... \$3.50
- E120 For Radio Frequency Amplification... 5.00

## FOUR-IN-ONE SCREW-DRIVER

E974 Each... 55c  
Especially suitable for radio work. Will handle any size screw used. Smaller drivers nest inside larger one and are held in place with screw cap. Made of steel, nickel finished. Every radio builder can use several of these handy tools.

## VACUUM TUBE SOCKETS

Our Special Socket. A wonderful value. Moulded entirely of brown bakelite. Four winding post connections. Right angled contact springs.

- E140 Each... 35c

## PORCELAIN BASE AND TUBE

E144 Crosley for either panel or table mounting... 35c

## High Grade combination type for panel or table mounting.

E146 Each... 45c

## TWO AND THREE GANG SOCKETS

These sockets make it easy to build a detector unit and make a neat, compact workmanlike job. Perfectly made of high grade materials. Quickly mounted on panel or base.

- E147 Two-gang socket... \$1.05
- E149 Three-gang socket... 1.45

## FIXED CONDENSERS

Moulded cases, nickel plated binding posts.

- E804 Each... 48c

## BRADLEYSTAT CARBON PRESSURE VERNIER RHEOSTAT

Current regulation is obtained by changing of pressure on carbon. This permits of infinitely fine variation of current. Very durable. Resistance 15 ohms. Capacity 2 1/2 amperes.

- E131 Each... \$1.65

## RADIO FREQUENCY AMPLIFYING TRANSFORMER

E995 Very special... \$2.  
This transformer will get 1 long distance stations loud & clear. Permits of easy shaft tuning. Helps cut out station interference. Makes your set sensitive enough to use loop aerial. Enclosed in metal case affording perfect shielding. Suitable for panel or mounting. Because of its special design can be mounted any V. T. socket. Works with any style tuner. Wave ranges 150 to 350 meters. Wiring diagrams included.

## OUR SPECIAL AUDIO FREQUENCY AMPLIFYING TRANSFORMERS

As high as three stages can be used without howling (due to proper impedance ratio, minimum distributed capacity, low core losses and proper insulation. Mounted style has bakelite panel with binding post connections. Unmounted has core and coils assembled with two holes in case for fastening to apparatus.

- E234 10 to 1 Mounted. Each... \$3.
- E235 10 to 1 Unmounted. Each... 2.
- E236 3 to 1 Mounted. Each... 3.
- E237 3 to 1 Unmounted. Each... 2.

## THORDARSON AUDIO FREQUENCY AMPLIFYING TRANSFORMER

An especially high grade transformer with correct high characteristics for Cunningham Radiotrons or A. P. Tubes. Wonderful results without distortion on one, two, three steps. Low distributed capacity. Fully mounted bakelite panel.

- E232 3 to 1 Ratio. Ea. \$3.
- E233 8 to 1 Ratio. Ea. 4.

## RADIO CORPORATION TRANSFORMERS

Audio Frequency Amplifying Transformer. Especially designed for Radiotrons tubes. 1 winding ratio.

## RADIO FREQUENCY AMPLIFYING TRANSFORMERS

Range 200 to 5000 meters. For long distance reception.

- E714 Each... \$5.11

## OUR COMPETITOR AUDIO FREQUENCY AMPLIFYING TRANSFORMERS

While these are very low priced transformers, nevertheless they give excellent results. They are carefully designed and carefully made. Quantity production and small profits make the low price possible. They will equal in results many transformers selling at much higher prices.

- E238 Unmounted, with wire leads... \$2.11
- E239 Mounted, with binding post connections... \$2.11

## BARAWIK SPECIAL PANEL MOUNTING VARIABLE CONDENSERS

E812 43 plate .001 Mfd. \$2.  
E813 21 plate .0005 Mfd. 1.11  
E814 11 plate .00025 Mfd. 1.11  
E815 3 plate Vernier... 1.11  
These are especially high grade condensers and we guarantee them to be mechanically and electrically perfect. Fine polished end plates of heavy bakelite. Shafts 1/2 inch diameter. Fully spaced to insure smooth, even reliable capacity. Our low prices save you money. These condensers are of the very best material and are not to be compared with many inferior cheap condensers offered. We guarantee them to please you or your money back.

## COMBINATION VERNIER VARIABLE CONDENSERS

E824 23 plate .0005 Mfd. with dial and knobs. Price... \$3.25  
E826 43 plate .001 Mfd. with dial and knobs. Price... \$3.95  
The latest improvement in combination variable condenser consists of regular variable condenser controlled by large knob and dial mounted with a three plate vernier condenser, which is controlled by separate knob mounted above the dial. This arrangement permits very fine tuning. Compact convenient mounting on panel. High grade design and construction. Finely finished.

## ENCLOSED VARIABLE CONDENSERS

One of the best made combination variable condenser. Rigid, accurate spaced aluminum plates. Finely polished ends. Engraved seal knob and pointer. Clear transparent case.

- E808 43 plate .001 Mfd. \$3.11
- E809 21 plate .0005 Mfd. \$3.21

## KNOCKED DOWN VARIABLE CONDENSERS

You can save money by assembling your own condensers. Formica top and base. Complete with all parts not assembled. Go together easily and perfectly. Panel mounting type.

- E820 41 Plate .001 Mfd. \$1.11
- E821 21 Plate .0005 Mfd. 1.11



# 50c EACH

## THE BIGGEST SUCCESS IN RADIO: CONSOLIDATED RADIO CALL BOOK CO'S. PATTERNS and DIAGRAMMS

# EACH 50c

### Complete Patterns, Diagrams and Instructions How to Make Your Own SHORT WAVE REGENERATIVE RADIOPHONE SET

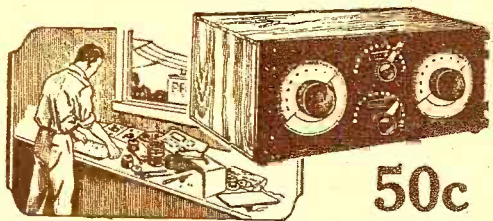

50c

One of the foremost Radio engineers constructed this set for us; it's simple to follow our patterns and assemble the parts comprising this set with which spark, C. W. signals and Radiotelephony may be received. We don't only give you pictures of how the apparatus looks, but each pattern is full size and printed on heavy blue print paper. Only standard parts are used.

**PATTERN No. 1**

Consisting of a Five-Page Illustrated Direction Pamphlet, size 8½x11½ inches, One Blue-Print pattern, size 16x22 inches and One Blue-Print pattern, size 17½x22 inches, all contained in a heavy Two-Color printed Envelope, 9x11 inches.

SENT POST-PAID

### DETECTOR and AMPLIFIER RADIO UNITS

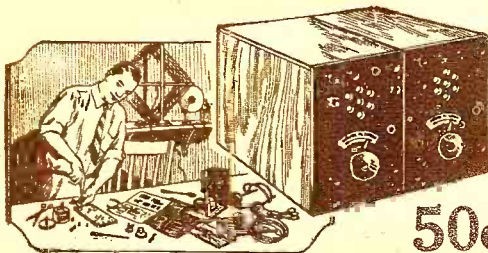

50c

You can build this detector and the amplifier units anywhere in your house; no machine shop is needed. When built they may be used with any type of Regenerative Receiver or short wave set, with which spark, C. W. Signals and Radiotelephony may be received. We've tested these patterns by actually building the outfit—they're perfect! Only standard parts are used in making the outfit.

**PATTERN No. 2**

Consisting of a Four-Page Illustrated Direction Pamphlet, size 8½x11½ inches, One Blue-Print pattern, size 16x18 inches, and One Blue-Print pattern, size 13½x15 inches, all contained in heavy, Two-Color Printed Envelope, size 9x12 inches.

SENT POST-PAID

### RADIOPHONE CRYSTAL SET

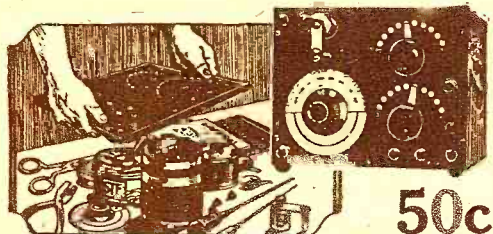

50c

We designed these patterns especially for those who are without technical knowledge but who are sufficiently abreast of the times to desire a radio receiving set in their homes. An instruction pamphlet comes along with the blue prints and all you have to do is follow the simple instructions. This radio set can be tuned in from stations within 30 miles. Standard materials only are used.

**PATTERN No. 3**

Consisting of 4-page illustrated Direction pamphlet, size 8½x11½ inches, one Blue-Print pattern size 16x22 inches. All contained in two-color printed envelope, 9x12 inches.

SENT POST-PAID

### 14 RADIO FORMULAE AND DIAGRAMS



Usefulness!

Economy!

Pleasure!

50c

With this packet of radio knowledge you need never worry about schematic wiring diagrams, measurements and radio tables. All formulas and diagrams are printed on heavy paper in black and blue; and contained in two-color printed envelope, 9x12 inches.  
SENT POST-PAID

### ALL ABOUT AERIALS

#### 12 Diagrams How to Construct and Erect All Types of Aerials



RECEPTION  
and  
TRANSMISSION  
ALL FOR

50c

THESE ARE DIAGRAMS THAT EVERYONE with a radio set wants and needs. These blue prints were made after practical erection of each aerial, and point out to you how simple it is to erect not only the proper aerial for your particular need, but how to erect this aerial in the most practical manner and at the least expense.

Consists of 12 blue prints 8½x11 inches and one four-page instruction pamphlet 8½x11 inches. All contained in a heavy two-color printed envelope 9x12 inches.

SENT POST-PAID

### 20 Radiophone Diagrams and Hook-Ups of

#### Crystal and Audion Receiving Circuits, Amplifier Circuits, Regenerative Circuits, Sending Circuits

with

#### Key Chart of Symbols and Pamphlet "How to Read Diagrams"



50c

These diagrams show how to get the best possible efficiency from the instruments you make or purchase. They cover hook-ups from the simplest to the most complicated, in a way that any amateur can understand and follow without difficulty. Get this set, and hook up right.

All 20 diagrams are printed on heavy paper, each sheet size 8½x11½ inches, and together with KEY CHART OF SYMBOLS and pamphlet "HOW TO READ DIAGRAMS" are contained in a heavy two-color printed envelope, size 9x12 inches.

SENT POST-PAID

ORDER FROM YOUR DEALER—or direct from us

## CONSOLIDATED RADIO CALL BOOK CO., Inc.

98 Park Place

PUBLISHERS

NEW YORK CITY



minded experimenter of the old school, I am sure that we shall meet some time or other soon. It would not surprise me greatly if it turns out to be at Matteawan. Well, "adios, amigo mio," which is Hungarian and means: "Yea, an antenna on the housetop is worth 18 in the radio catalog." Gn 73's.

**Terms Used In Radio Practice**

By JOHN D. FORREST

(Continued from January issue)

**Cocher:** One who listens in, in conjunction with another.

**Compass, radio:** An instrument constructed by sea skippers as devised to reflect upon their navigating skill. Used by radio fiends in apartment houses and other residences of cornet practitioners.

**Continuous waves:** Expedient resorted to by modern women. Sometimes called Marcel or permanent waves, used to hide hairpins and middle age.

**Converter:** A machine for changing the round holes in doughnuts into those of trapezoid form.

**Coupler:** A darkly attired individual with a long face who is the original cause of divorce.

**Current, damped alternating:** Expression used by curious persons who touch live, public service companies' power mains.

**Cyclogram:** A message transmitted by means of a bicycle.

**Cyclograph:** A cyclograph is a-er—Why, don't you know what a cyclograph is? Any dunce knows that.

**Damping:** A peculiarity of speech indulged in by a bachelor who has lost his singly possessed collar button down the drain pipe.

**Dielectric:** The ultimate end of persons who read "Danger, High Voltage" signs and are not convinced until after the coroner arrives.

**Discharger:** The successful competitor in an argument between the boss and bossee.

**Earth:** An object of great weight mainly used to hold down balloons. Also a segregating place for radio fiends. It is traversed by great continents, great waters and traveled by people who would rather pay \$79.53 for a sardine in Paris than \$.17 for lobster a la Newburgh at home in Weehawken. The earth serves as a starting point for endless arguments on wave propagation, cures for sciatica, and a minimum wages for working girls. Much used for the planting of grass, maize and antennae.

**Eddy currents:** A species of electricity discovered by Mr. Eddy, of "Indoor Sports" fame.

**Electric-stress:** A lady electricist. **Electromagnetic waves:** A natural phenomena utilized for the broadcasting of

**Ground:** A process through which chalk and limestone goes before being mixed with sugar and sold on the market for 73c per pound. Also a resting place for dissipated static currents, losing duellists and much dug up by archaeologists and prohibition agents in search of the missing link and rye respectively.

**Impedance:** A large weight locked about the ankles of boarders at Ossining, New York.

**Jigger:** One of the fans who reads the comic papers in pursuit of the adventures of one Dinty Moore, et al.

**Static:** A fiendish device imported from tropical climates to keep the radio experimenter from heaven, a factor which has greatly affected the language of millions between 1898 and the present.



*If* you had a dozen ears

You would need them all to hear what you get nowadays with a single circuit receiver.

With several hundred powerful broadcasting stations, all operating on one narrow wave band, it takes real selectivity and sensitivity to get a satisfactory radio programme.

The Paragon three-circuit receiver gives you any station you want when you want it—and no other. Clear, complete programmes without interruption or disturbance. A modern, high-grade, scientific instrument built right to give results.

Ask some experienced amateur what he knows about

**PARAGON**  
Reg. U. S. Pat. Off.  
**RADIO PRODUCTS**

The amateur will tell you that the Paragon three-circuit receiver, because of its greatly superior selectivity and sensitivity, can pick and choose between broadcasting stations of about the same signal strength with less than one per cent differential.

This means that with a Paragon receiver you get what you want when you want it—complete messages and clear music from the station you tune in on, without interruption and jamming. Until you have listened in with a Paragon three-circuit receiver, you cannot guess the real pleasure and fascination of radio.

Long before broadcasting popularized radio with the general public, Paragon equipment was the choice of the experienced amateur. He will tell you today that if you want quality and satisfaction, Paragon Radio Products are the best and safest buy on the market.

*An illustrated Catalog of Paragon Radio Products is Yours For the Asking*

**DEALERS** — The Adams - Morgan Company has an interesting proposition to make to reputable radio dealers who believe in quality merchandise. Details on request.

**ADAMS-MORGAN COMPANY**  
 6 Alvin Ave., Upper Montclair, N. J.

- Also Manufacturers of PARAGON**
- |                     |               |
|---------------------|---------------|
| Radio Telephone     | Amplifier     |
| Transmitters        | Transformers  |
| V. T. Control Units | Control Dials |
| Rheostats           | Amplifiers    |
| Potentiometers      | Receivers     |
| V. T. Sockets       | Switches      |
| Detectors           | Variometers   |

Type RD-5 Regenerative Receiver and Detector—\$75.00  
 Type A-2 Two-Stage Amplifier—\$50.00  
 (Licensed under Armstrong Patents.)

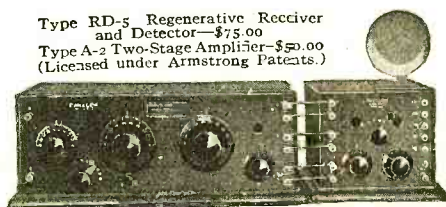

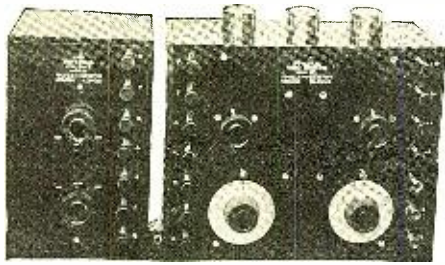

## STOP INTERFERING WITH YOUR NEIGHBOR'S RIGHTS

### By Making a Miniature Transmitting Station of Your Own Receiving Set

Install a Universal Radio Receiver and Coil Unit which has incorporated in each all the fine points of Radio Engineering.

This set, by use of a coupled circuit in tuning, does not disturb nearby receiving sets by setting up oscillations of its own on any wave lengths from 180 to 2400 meters. This feature is highly desirable in view of the fact that such interference will eventually be eliminated voluntarily or by legislation.

The wave length range possible with Coil Unit is 180 to 6200 meters.

The Receiver is equipped with detector and two-stage audio frequency amplifier mounted in one cabinet, while the Coil Unit is in a separate cabinet.

The Universal Radio Receiver makes use of a device to PREVENT DISTORTION which, in effect, operates as a permanent "C" battery. This set will always operate at its maximum efficiency and SIGNALS WILL ALWAYS BE CLEAR AND INTELLIGIBLE.

The wave length of the secondary circuit is tuned to that of the primary circuit by means of a variable condenser, thus giving approximately 4 times the wavelength variation possible with variometer tuning.

BANK WOUND COILS, which is the best known form of winding, are used throughout.

THE SELECTIVITY IN TUNING of this Receiver is obtained by the use of the coupled circuit which allows sharper and stronger signals to be received than by means of other circuits.

We guarantee the workmanship and quality of this set to be of the highest type.

A demonstration of this set will prove conclusively that it is the biggest advance yet made toward a perfect Radio Receiver. If your dealer cannot supply you, kindly write us.

Price F.O.B. Factory

Universal Radio Receiver \$90.00      Universal Coil Unit..... \$20.00

## HAYES & NEWTON

115 N. Market Street,

URBANA, ILLINOIS

# This Loud Speaker is a Genuine Surprise

Clear, resonant tones distinguished the Moon Loud Speaker. You'll like it—immensely! Made right for sound without distortion.

## A Splendid Instrument

Extra heavy aluminum highly polished. Seamless horn. Spun like silverware; in one piece. Horn turns in socket any direction without moving base. Height 15½ inches.

EVERY radio home can enjoy its agreeable advantages. Try it.

If your dealer is not demonstrating the "Moon", write us direct.



Only \$7.50

Dealers and Jobbers: Write for terms

## Wilson Utensil Co.

450 East Third Street, DAYTON, OHIO

## The Future of Commercial Radio

(Continued from page 1634)

sole purpose of seeing what the results would be. The recent tests were so successful that they are now formulating plans for the erection of a powerful telephone set. This new station will probably be located in Denmark and will handle any ship traffic which may come by telephone. Their idea is to stipulate this new proposition. The telephone transmitting unit is nothing more than the necessary apparatus being connected up with the ship's 1½ kilowatt C.W. outfit. It is of Danish manufacture, possessing a most efficient telephone transmitter and a highly efficient modulating bulb, with 12 volts on the "filament" and 60 volts on the "plate." When using the voice, 6 amperes radiation is realized. Much of the efficiency of the entire transmitting outfit, as a whole, is said to be made possible only by the use of a special insulator they employ, whereby there is no energy lost.

As was stated previously the power rating of the C.W. set is 1½ kilowatt. The necessary power is supplied by a generator located in the ship's engine room and when using full power, a radiation of 11 amperes is realized. There are two rectifying bulbs and one power tube. It is almost identical to the one found aboard the *Aquitania*, with the exception that arrangements are also made so that interrupted C.W. transmission can be carried on. Using the C.W. set, it was possible to carry on communication over a distance of 2,300 miles. This feat was accomplished last Summer, when traffic was sent to WCC and WSE, on a wavelength of 2,100 meters. The C.W. set is used most of the time so as to cause little interference to others who may be attempting to receive or transmit messages.

The receiving installation aboard this vessel is most interesting and out of the usual. The "piano" tuner, a picture of which is shown herewith, and a long wave receiver are used, together with a six-stage amplifier, which is somewhat out of the ordinary. Besides this there are also a 2-stage low-frequency amplifier and a bulb for detector. With such an installation we can readily imagine what results could be accomplished. The receiver will tune anywhere from 200 to 23,000 meters. Each tube of the amplifying unit has 48 volts on the "plate" and 6 volts on the "filament." The current for the plate supply comes from a bank of storage batteries, located under the operating table and charged, not by a separate generator, but by an arrangement of lamps, etc. The tube used as detector has 6 volts on the filament and 24 on the plate, best results being accomplished with this arrangement.

Though of less importance, the spark transmitter on this vessel is worthy of consideration. Despite the fact that it is only a 1½ kilowatt quench gap transmitter, considerable distance has been covered. It has a daylight range of 600 miles. Arrangements are made so that communication can be carried on over a wide range of wave-lengths. The wave-lengths are varied by simply revolving a switch. A separate motor-generator is used for this set and here we find the old type of hand starter in evidence.

In addition to this equipment, the United States carries an attractive ¼ kilowatt quenched gap type of spark transmitter with a guaranteed daylight range of 275 miles. A 24-volt storage battery runs the small generator. In conjunction with this set, is an eight leyden jar type of short-wave condenser, a necessity due to the size of the ship's antenna.

# NATIONAL AIRPHONE PRODUCTS

Pronounced by Experts to Be the Greatest Radiophone Crystal Outfit Ever Produced. Awarded the Certificate of Merit by the "Radio News Laboratories," N. Y. Tribune Institute, N. Y. Evening Mail Institute.

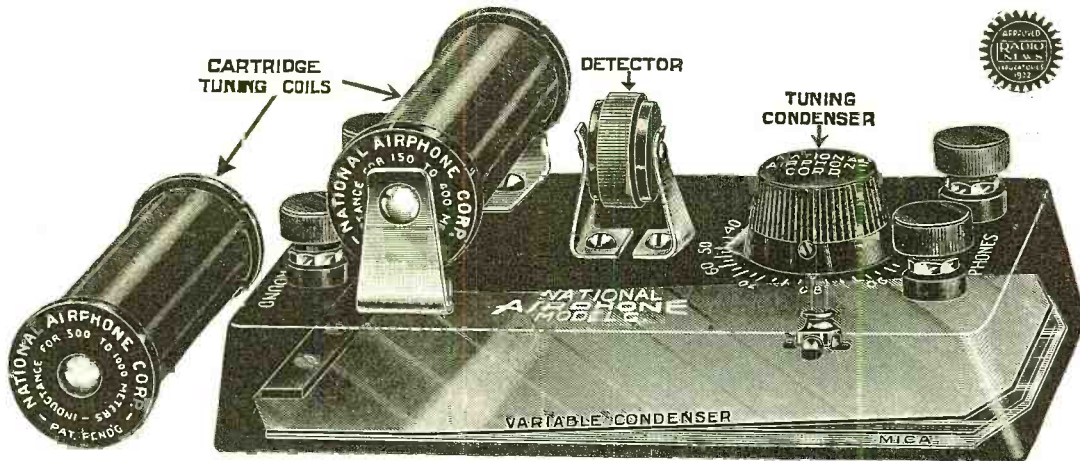

**\$12.50**  
Without  
Phones  
Patents Pending

## NATIONAL AIRPHONE (MODEL G)

Endorsed by Engineers as the Greatest Radiophone Ever Seen or Heard

To operate simply connect aerial, ground and head-phones. Will receive radio broadcast entertainments and commercial reports within a radius of 25 miles; Code signals 1000 miles and over depending upon coils used.

### OUTSTANDING POINTS OF SUPERIORITY

1. Most Compact Radiophone Receiving Set Made.
2. Rugged construction throughout, nothing to get out of order.
3. Entire casing constructed of hard rubber composition. No wood, no warping, no losses through leakage.
4. Ultra-sensitive Foolproof Detector; entirely enclosed in composition case. Air and dustproof, no fussy minerals, no Cat-whisker, no balls nor springs.
5. Use of interchangeable cartridge tuning coils gives wide range over which radiophone broadcast or radio telegraph signals can be heard. 25 miles or over for radiophone concerts; up to 1000 miles for telegraph signals depending upon coils used.
6. Two Cartridge tuners, supplied with each outfit; one takes in general broadcasting stations 150 to 400 meters, the other ranges from 500 to 1000 meters.
7. Variable Mica Condenser used in acme of simplicity—high capacity, impossible to short-circuit.

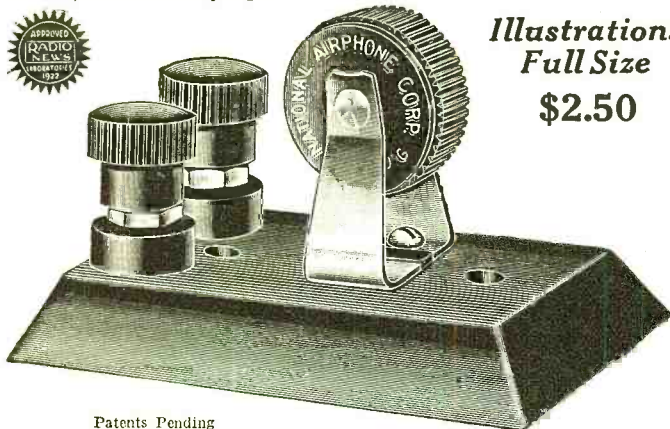

### GOLD GRAIN DETECTOR

After you have fussed with catwhiskers, springs, balls and adjustment handles, and after you have almost become a nervous wreck, hunting for "the elusive sensitive spot"—you will welcome with open arms our 100 per cent. GOLD GRAIN DETECTOR.

This Detector has no catwhiskers, no springs, no balls, no adjusting handles; no fussing; 100 per cent foolproof. The Detector is entirely enclosed in hard rubber composition cartridge, but it is NOT a fixed detector.

A special crystal is used, while contact elements are made of pure gold. There is always a multiplicity of contacts. The Detector is sealed hermetically. The contact with the crystal is always perfect.

Due to these revolutionary improvements, this Detector has been pronounced by experts to bring in signals and sounds louder than any other detector on the market. You will be surprised at the great volume of sound you are able to obtain with the GOLD GRAIN DETECTOR.

FOR PANEL MOUNTING \$2.00

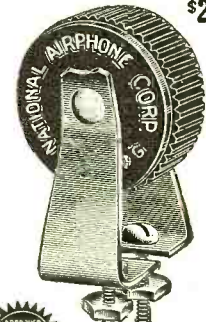

### You are protected by this Guarantee:

Should any National Airphone Gold Grain Detector not be in first-class condition when purchased and within five days you return it to us unbroken, or unopened, we will refund your money or give you another one as you may prefer. Or if at any time within a year one should become defective or unsatisfactory to you we will take it back if unbroken or unopened and give you another in its place.

### SEND NO MONEY—COUPON

R.N. 3

National Airphone Corporation,  
18 Hudson Street, New York City, N. Y.

Gentlemen:  
Please send me prepaid .....  
for which I will pay the postman the amount advertised on this page.  
If within five days I do not find the apparatus all you claim for it,  
or if for any reason I am not satisfied, I may return same to you in good condition and you will refund the full purchase price.

NAME .....  
STREET AND NO. ....  
CITY ..... STATE.....

Distributors--Write for Exclusive Territory  
Jobbers and Dealers--Send for Price List

NATIONAL  
**AIRPHONE**  
CORPORATION  
18 HUDSON STREET NEW YORK

## The Need for Dependable Electrical Instruments

WHETHER in transmitting or receiving—correct voltage or amperage information is of utmost importance to efficient and economical operation. Control of the filament current or filament voltage makes it possible to prevent premature burnouts. Facilitates exact tuning. Duplicates results instantly. The Weston Filament Voltmeter and Filament Ammeter have been designed expressly to meet these requirements. Accurate determinations of the plate voltage are also desirable. The Weston Plate Voltmeter is a necessity on every Transmitting Set and a convenience on all Receiving Sets. Effective transmission depends upon the proper antenna current flow. The Weston Thermo-Ammeter is recognized as the most highly developed, scientific and dependable instrument for this purpose.

*Booklet J, and other Radio Literature, describes and illustrates these various Weston instruments. Everyone interested in Radio should send for this important data. If your dealer cannot supply you with Weston instruments, we will gladly see that your needs are promptly supplied.*

**Weston Electrical Instrument Co.**  
173 Weston Ave. NEWARK, N. J.

*Electrical Indicating Instrument Authorities since 1888*



### Professionals Know—

That the one vital point about receivers is SENSITIVITY—the feature that enables the phones to catch every vibration; get what's going and get it clearly. Thousands of working operators all over the country will testify that Elwood Headsets do just that thing.

Carefully constructed to give real service; solid brass cases heavily nickel plated; head bands that are comfortable in design and easily adjusted—outward evidence of inward quality.

2000 Ohms
<b>\$5.50</b>
3000 Ohms
<b>\$6.50</b>

Sold by Dealers nationally. If yours cannot supply you, we will send direct on receipt of check. Money refunded if they fail to please you.

*Prices in Box*

**ELWOOD ELECTRIC CO. INC.**

2 Randall Ave.,

Bridgeport, Conn.

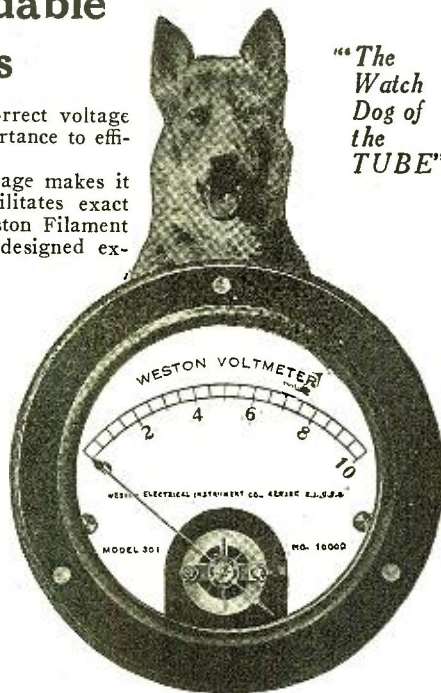

*"The Watch Dog of the TUBE"*

## Results of the \$500.00 Prize Contest

*(Continued from page 1621)*

they are oftimes wont to admit. We have no complaint to make against the conscientious Amateur, operating his transmitter within the law.

We plead for enforcement of existing laws governing the subject in hand, with such amendments as may seem necessary for the betterment of the situation as it exists today. We do not wish to eliminate the Amateur, we wish merely to have him keep within his allotted wave band, and not overstep his decrement.

The contention has been made that the Amateur should have priority in all cases because of the beneficial nature of his work. Are not we as capable of furthering the advancement of the art as the Radio Amateur? A certain percentage of us are developing into Amateurs, while a still larger percentage could be classed as both Amateurs and Enthusiasts. It is true that the Amateur was first in the field, but it is also true that the horse preceded the automobile, yet the operator of a horse-driven vehicle does not hesitate to give an automobile its share of the road—nor do the operators of such overstep the traffic laws. We interfere slightly, if at all, with Amateur activities, yet many Amateurs constantly interfere with our innocent enjoyment.

We do not petition for transmitting licenses, in order that we may make ourselves heard the length and breadth of the nation, but only for a quiet zone, as far as code work is concerned, in order that we may listen to our favorite broadcasting station.

We have among us, a large group of serious minded persons who are attempting to do their bit for the advancement of the art, and no doubt they are accomplishing as much at present as the parallel group of Radio Amateurs. We should, therefore, have our rights respected, and be given a definite place in the scheme of things.

It is true that the Amateur rendered the country a valuable service during the World War, but did he render a greater service than the private soldier? Was his sacrifice any greater? Was he not better off than he would have been, had he not been a code man?

Something must be done, and we believe we are entirely within the limits of reason when we petition that Amateur activities be held in a more strict conformance with the law, and that steps be taken to minimize Amateur interference with broadcast entertainment.

The contents and arguments of the defendants are as hereinafter shown:

We, as Radio Amateurs, are as eager for a settlement of conditions as the plaintiffs.

We were first in the game. We were working out many of the great problems confronting the radio art years before the radiophone, or the Radiophone Enthusiast were known. We are in no small measure responsible for the present day development of the radiophone and the radio telegraph. Daily we transmit hundreds of messages to the most distant points in our country, free of charge—a distinct public service.

We rendered a necessary service during the World War, filling in the ranks of radio operators and repair men in the Army and Navy, where it would have been next to impossible to have turned out half the number of highly trained men necessary for such a project as the World War without our assistance. Is it not possible that sometime we may be needed again?

Many of the most prominent men in the electrical world today received some of their most valuable training while in the ranks

**T**HIS De Forest D-7 Reflex Radiophone\* is the famous receiver which has been attracting nation-wide attention by receiving half the Continent on an indoor loop aerial, under most adverse receiving conditions. It is notable for the elimination of extraneous noises and the absence of distortion, and its single-knob control makes it particularly easy to operate. This is probably the most compact, beautiful, and highly selective receiving set in existence. De Forest dealers carry both De Forest and RadioCraft sets.

De Forest Radio Tel. & Tel. Co.  
Jersey City, N. J.

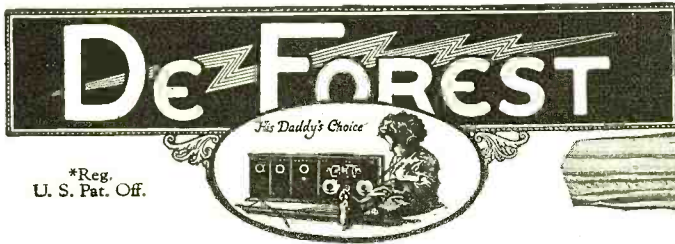
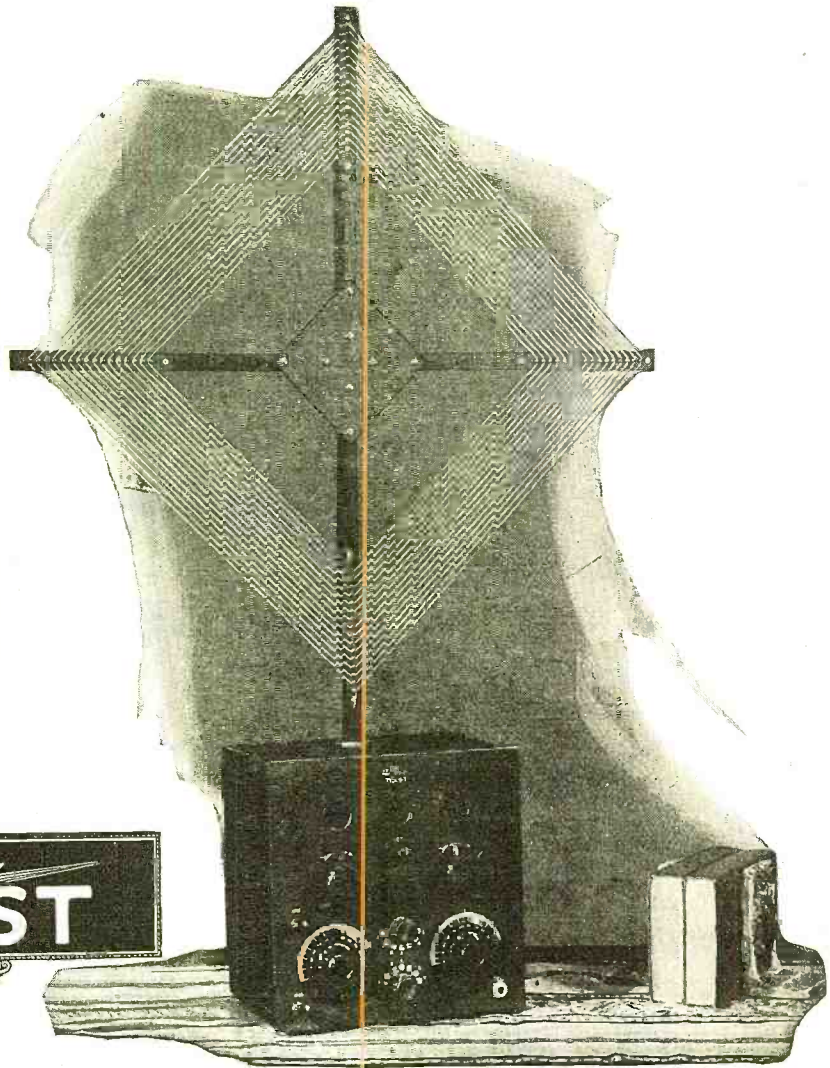

\*Reg.  
U. S. Pat. Off.



The  
RadioCraft Co., Inc.  
139 Franklin St.  
Jersey City, N. J



**H**ERE'S the regenerative receiver that has worked a transformation in many a home! RadioCraft's D-4 offers the long-distance reception of the regenerative circuit, and the D-5 2-step amplifier actuates a loud speaker so that the whole room can enjoy the broadcast. When you add to the regenerative principle the long tested reliability of the De Forest parts of which these sets are made, you get a combination which at a low price touches the high spot in present day radio.

# Here's a Pair of Winners



The Wimco Condenser

Made to meet a demand for quality—highest efficiency, 3 plate, 23 plate and 43 plate sizes.



The Carco Coupler

Just the thing for the popular receiving set. Bakelite tube, and rotor, silk covered wire, perfect contacts.

*We invite Dealer and Jobber inquiries.*

Send for literature and prices on Wimco Socket for WD11 tube.

**THE WIRELESS MFG. CO., CANTON, OHIO**  
 MANUFACTURERS                      DISTRIBUTORS

# The Telmacophone in Your Home



## Makes Your Radio Set Complete

You can enjoy every minute of the entertainment—hear every word and sound, clearly and distinctly. No need to change headphones from one person to the other. Everybody hears everything.

*Original*  
**\$20.00 Loud Speaker and Still The Best**

Tone is produced by *Original Baldwin Type C Unit* and reflected into other horn. No metallic affect. Beautifully finished in black and gold.

Correctly designed—fairly priced—unreservedly guaranteed. With *original Baldwin Type C Unit*, complete \$20.00.

Insist on the *Telmacophone*. If your dealer hasn't it in stock, send us his name and order direct from this ad. Enclose \$20.00. Prompt shipment. Write for new free catalog

**RADIO DIVISION**  
**TELEPHONE MAINTENANCE CO.**  
 20 S. Wells Street Dept. B Chicago, Illinois

**TELMACO**  
*Quality Radio Exclusively*  
**JOBBER! DEALERS.** The demand for the Telmacophone is great. Write for new catalog and discounts on our complete line. We are also distributors for the better standard lines.

of the Radio Amateurs. Are not we, and our work as we perform it, an educational force of no small magnitude?

The Amateur, or Experimenter if you prefer, is usually willing to spend his last nickel and pawn his watch for another instrument or book that will aid him in his work. Is such a spirit to be disregarded? Is it not such enthusiasm the forerunner of great things? We cannot believe that this country is developing into a place where self-education is curbed or restrained.

Compare our attitude with that of the uninformed person who spends a small amount of his money for a radiophone receiver (usually a poorly constructed, broad-tuning affair), and then when he has hardly worn the cans long enough to train his ears in place, wants to oust the old-timers, and completely obliterate them from the face of the earth, in order that he may get that extremely important cornet solo from some broadcasting station.

Are you, as Americans, going to destroy, or legislate to a point where further work will be mockery, a group of fifty thousand or more of your young countrymen, with the record that we have, in order that a group of pleasure-seekers may have their enjoyment?

We are willing to give up half of our inherent right to the air to our radiophone neighbor, but should we be dealt with in any more severe a manner than the present radio laws provide for? Should we be continually condemned by a group of people who in many cases cannot tell the difference between an interfering wave and an arc light hum (in many cases, no doubt, the latter)? Shall our transmitters be silenced during the cream of the evening in order that the Radiophone Enthusiast may play? Would not the motto, "Work Before Play," be especially fitting in this case?

All we ask is that we may retain the rights and privileges already allotted us by existing legislation, in order that we may carry on our work unmolested by our new friends, and that we be not confused with the fellow operating a transmitter without the law, and without reason and consideration. We are against such a chap as much as you—but he is a case for the authorities, and an enemy to both of us.

We submit the case.

This question comes for the first time before this court, hence it is without a precedent, but the urgent demands of the public, and the irrepressible conflict of the parties, necessitate an immediate decision until relief can be obtained through the channels of the legislature—the source of our laws.

In view of the condition of affairs as brought out by the case in hand, the Court recommends the following for the serious consideration of the Legislative bodies of the United States for amendment and revision of the existing radio laws and regulations:

1. That the Radio Amateur, as heretofore, be allotted a definite band of wave-lengths, and upon which he may transmit at any time, except as already limited by the existing regulations.

2. That there be set aside, just above this band, and just below the lower limit of the radiophone broadcasting station band, a silent zone, or a certain band of wavelengths upon which it be made unlawful for either the Radio Amateur or the radiophone station to transmit—this band to be at least fifty meters in extent. (The court is aware that such a "silent zone" is more or less provided for in present laws, but the facts of the case prove that it exists more in theory than in fact).

3. That it be made unlawful for any Radio Amateur to operate a damped wave transmitter after some future date—to be determined.

4. That closer scrutiny be given to Radiophone Broadcasting Stations, both those in existence and contemplated stations, in order

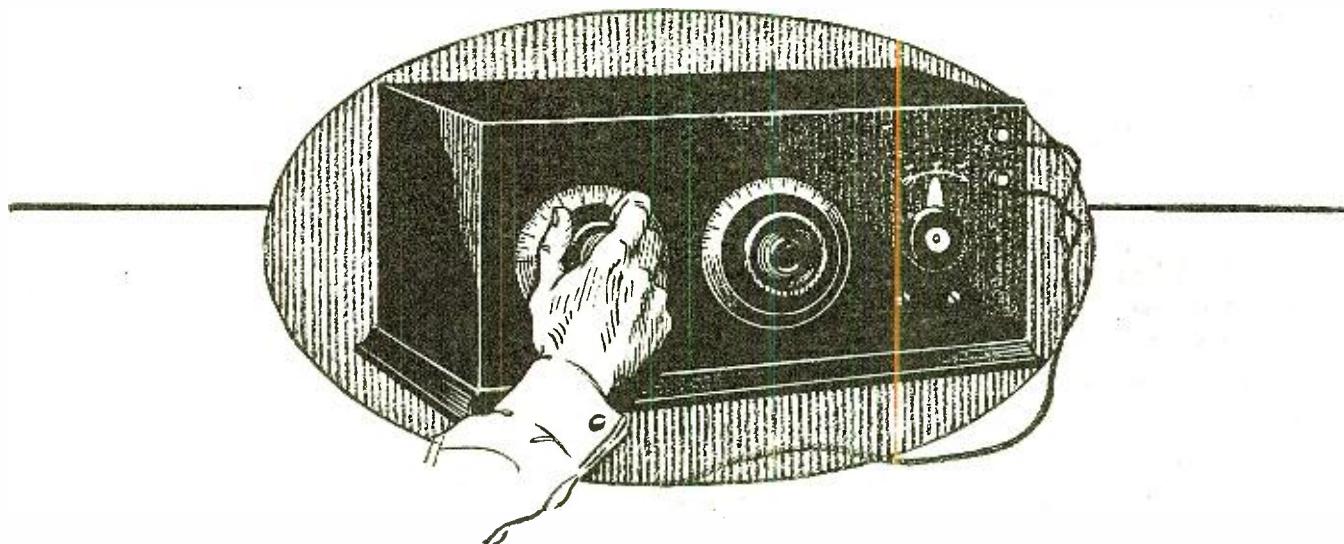

## Why Formica Is Preferred Insulation.

**S**ALES of Formica for radio insulation exceed those of any other material because Formica has qualities that radio engineers as well as amateurs value very highly.

Formica panels are incomparable in appearance. The splendid gloss finish is perfect. It can be converted into a satin finish equally fine.

Formica has the highest and most uniform dielectric strength—and that strength is permanent. It does not acquire water content either by internal chemical action or absorption. After a year or two of use is when the Formica panel is most appreciated.

Formica is remarkably uniform in its qualities. You can count on its performance with certainty.

Formica is approved by the Navy and the Signal Corps and has been certified by the United States Bureau of Standards.

But it holds its dominating position by virtue of the preference of active radio men everywhere—both amateur and professional.

Formica is now available everywhere for quick delivery. There is no reason to use materials in which you have less confidence.

*Dealers: When you stock Formica you profit by the important advertising and sales co-operation that we have arranged for dealers.*

**THE FORMICA INSULATION COMPANY**  
4618 Spring Grove Ave.  
Cincinnati, Ohio

*Sales Offices:*

50 Church St., New York, N. Y.  
422 First Avenue, Pittsburgh, Pa.  
1042 Granite Bldg., Rochester, N. Y.  
415 Ohio Bldg. . . . . Toledo, Ohio

Sheldon Bldg., San Francisco, Cal.  
Whitney Central Bldg., New Orleans  
414 Finance Bldg., Cleveland, Ohio  
9 S. Clinton St. . . . . Chicago, Ill.

1210 Arch St. . . . . Philadelphia, Pa.  
313 Title Bldg. . . . . Baltimore, Md.  
1819 Lyndale Ave., South, Minneapolis, Minn.  
47 King St. . . . . Toronto, Ont.

**FORMICA**  
Made from Anhydrous Redmanol Resins  
**SHEETS TUBES RODS**

TRADE **ESCO** MARK

**THE AMATEUR TRANSATLANTIC TESTS SHOW**  
(At the time this Adv. was written)  
**THAT MORE OPERATORS SUCCEEDED IN GETTING ACROSS WITH "ESCO" MOTOR-GENERATORS**  
Than With All Other Makes Combined

Paul Godley is using an Esco Motor-Generator in England. 8BSS Cazenovia first to be heard in Switzerland. Same station 8AQO heard in England, France, Switzerland, first 8 nights. 1BGF Hartford, first to be reported back. Very many others made remarkable records with our apparatus.



This is a special four unit set for the largest broadcasting station in existence. A 10 h.p. 220 volt, 60 cycle, 3 phase motor—two 1000 v. 2000 w. Generators designed to operate in series, thus producing 2000 v., 4000 w., and one 12 v., 2000 w. filament current generator. Besides making standard outfits in over 200 combinations, we are constantly developing special apparatus for special purposes.

*Battery Charging Motor-Generators in Many Sizes  
Motors—Dynamotors—Generators—Motor-Generators*

**ELECTRIC SPECIALTY CO.**  
211 SOUTH STREET, STAMFORD, Conn., U. S. A.  
SOLD BY PRINCIPAL DEALERS EVERYWHERE

**QUALITY CLEARSTONE ACHIEVEMENT PRICE**

Unusual manufacturing facilities, greatly increased production, and a firm desire to produce for the American people a high class Radio set at a price within the reach of all, has enabled us to bring out our new Radio Frequency Model RFAA-60.

This set incorporates a tuner, one stage Radio Frequency Amplifier, Detector and two stages of Audio Frequency Amplification, set in a solid Mahogany Cabinet of standard Clearstone design. An idea of this Cabinet design may be obtained from our ad on page 963 of the December Radio News.

Exceptional results are obtained with this set, especially in its use with a loud speaker, no additional amplification being necessary. Strictest regard has been paid to all engineering details. The set covers a wave length range from 270 meters to 600 meters, and is so arranged that maximum amplification is obtained on all wave lengths. For wave lengths above or below this range, special Radio Frequency Transformers may be used, and means are provided for clipping them in as you would a renewal fuse.

The list price of this astonishing new Clearstone development is only \$60.00. At this price a 4 Tube set, including the well known principle of Radio Frequency Amplification, is available to all.

In line with our policy of lowest possible prices, we wish to announce a new list price on Model TDAA-55, of \$60.00 net. At this price, Model TDAA-55 represents the greatest quality and value that is possible for anyone to put into a set. It comprises a Tuner, Detector, and two stage A.F. Amplifier mounted in our standard Cabinet. A noteworthy feature of this set is the use of the famous rectangular induction unit Variometers and Coupler, (licensed under U. S. Patent No. 1,408,992).

Model TDAA-55 has built for itself an enviable reputation as testified by hundreds of satisfied users, and at its new list price, should make thousands of new friends.

So thoroughly certain are we, that anyone who views either one of these sets will want one, that we will, on receipt of your order, ship to you at any point in the United States, one of these sets C.O.D.; and we will direct your agent to allow you the privilege of unpacking and examining the merchandise before paying for it. If you are not delighted, you need not pay a cent. This policy is inaugurated in order that you may feel that you are perfectly safe in ordering from us.

*Order from this ad or write for catalog of our products. Attractive proposition to dealers.*

Model RFAA-60, code word—abroad—Price \$60.00  
Model TDAA-55, code word—aback—Price \$60.00

**THE CLEARSTONE RADIO COMPANY**  
McMillan and Essex Place Cincinnati, Ohio, U. S. A.

**A QUALITY BATTERY**  
Always Dependable  
Marko Storage Battery Company  
1404 Atlantic Ave. Brooklyn, N. Y.



**ENGRAVING MACHINES**  
For RADIO PANELS  
And Other Radio Engraving  
ENGRAVERS & PRINTERS MACHINERY CO.  
Sag Harbor, New York

to reduce interference from this source, and, if possible, improve the quality of the entertainment.

5. It is further recommended that an effort be made, by enlisting the aid of radio magazines, radio clubs and organizations, radio departments in newspapers, and radio manufacturers, to teach the radio public the advantages of a selective receiver.

6. That closer scrutiny be given to amateur stations, both in regards to their operating wave and decrement, and that they be held strictly within the law in all cases.

7. And further, that the aid of the above named organizations be enlisted to encourage research in non-radiating receivers, and that prizes be offered, etc., for solution, or partial solution, of the problem of re-radiation.

8. Lastly, the Court recommends that every consideration possible be given to both the Radio Amateur and the Radiophone Enthusiast, but that any person operating a station without the law be absolutely eliminated from the air, and that especial effort be made by authorities to run down such cases and bring them to justice.

**What Shall the Amateur Do To Save Himself?**  
By STEM ANDERSON  
**Sixth Prize**

A radiophone owner—one of many thousands—perhaps typical of the kind who do not consider the radiophone as a novel method of getting solos, instrumental music, lectures, etc., just when he had perfected a new hook-up—one of promise of distance and clarity of tone—found that he had interference from the spark artist of the type who cares not when or how he pounds the key. At first tolerance was shown, then disgust with reception and finally exasperation at the continuous interruptions of the spark artist; this led to getting in touch with a friend who could read code and who positively identified the sender, an amateur of so poor ability that it goes without saying that somebody slipped when that license was granted.

Then one evening when a distance record was being sought and the radiophone owner had picked up a 1300 mile station—*dddaaaah ddddaaaaaah ddiit ddddaaaaaahhh daaah-\*\*\*\*\** drowning out everything—is it any wonder that the R. O. exploded?

That same day several spark artists had assembled and formulated a schedule for operation causing least interference—the five word a minute ARTIST also signed the agreement that he would conform to their schedule and during the evenings not operate before 10 o'clock—yet here it was only 8.35 and the long drawn out dashes and dots came painfully through the air. R. O. went to the telephone and asked for the S. A. and when he asked said S. A. if he were operating in violation of the gentleman's agreement was told that it was none of R. O.'s business. When the events of the day were re-capitulated and the conversation became heated R. O. was told to go straight to—and further that until Uncle Sam passed rules and regulations confining him to certain fixed periods he would operate when he — pleased also just to show me how he felt he would go down into the basement and send right now.

Does the above S. A. represent the real amateur? **DECIDEDLY NOT!** Does the above R. O. represent the average possessor of a radio phone? **YES, ASSUREDLY!**

The point that must be impressed on radio amateurs—either spark or radiophone—is that just because of the presence of such mischief makers the bulk of the fans must ultimately suffer and have their privileges annulled.

The amateur in the Radio game—the one who does things and not the leech that lives on amateurs' experimentation and claims same as his own discovery—have a most



# "With



## The Oard *Phantom* TRADE MARK Receptor

No need of either a cumbersome aerial or complicated loop system with the *Oard PHANTOM Receptor*. It requires neither aerial nor ground connection—only a piece of ordinary lamp cord not exceeding 50 feet in length, concealed in the picture molding, thrown over a piece of furniture, or uncoiled wherever most convenient. So simple anyone can operate it, yet far more efficient over both short and long distances than complicated types of receivers. Highly sensitive and remarkably selective. The set supreme for every location and purpose. See a demonstration at the nearest A-P dealer's, or write for folder.

Licensed under Armstrong Patent No. 1,113,149 for amateur and experimental use.

### Atlantic-Pacific Radio Supplies Company

646-50 Mission St., San Francisco, Cal.

*Sole agents of Oard Radio Laboratories, Stockton, Cal.*



*but a 5-foot wire  
thrown over a  
desk, my wife  
and I listened  
to a concert from  
Portland, Oregon  
over 600 miles  
distant."*



Among the many enthusiastic letters received each day from the Oard PHANTOM Receptor owners, is one from Mr. S. C. Ryland, Stockton, Cal., which says in part—"With but a five-foot wire thrown over a desk, my wife and I listened to a concert from Portland, Oregon, and although the distance is over 600 miles, it came in loud and clear. The set is wonderful also for its selectivity. Stations but one degree apart on the selection dial may be tuned in without one interfering with the other. I have listened to stations hundreds of miles away without interference from a powerful local station broadcasting at the same time." Results like this are not at all extraordinary. Stations from 500 to 2,000 miles distant are heard clearly and repeatedly by owners of this marvelous set.

*The Atlantic-Pacific Radio Supplies Co. also distributors for—*

- Cutler-Hammer Mfg. Co. .... Rheostats & Potentiometers
- Alden-Napier Co. .... Sockets & Dials
- Carter Radio Co. .... Telephone Plugs & Jacks
- Dayton Fan & Motor Co. .... Variometers & Variocouplers
- Pacent Electric Co. .... Telephone Plugs & Jacks
- A-P RADIO PARTS .... Transformers, Condensers, etc.

# Increase your Range

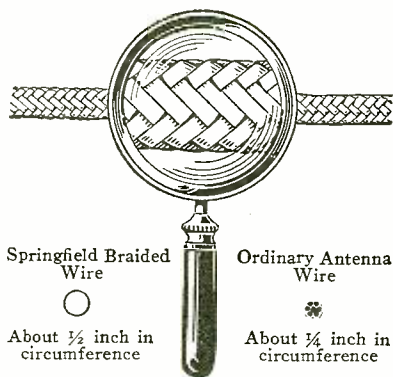

Springfield Braided Wire

Ordinary Antenna Wire

About 1/2 inch in circumference

About 1/4 inch in circumference

with your present equipment

## Springfield 16 Strand Braided Antenna

125 feet in your attic, in strands 3 feet apart, gives better results than 150 feet of ordinary wire outdoors. *Read what they say:*

"Proven far superior to anything, after extensive tests."

"Very best thing obtainable for loop antennae."

"45% more efficient than 7 strand No. 22."

"Far superior to ordinary copper."

"1000 miles—with 3 turn loop with detector alone."

"Received clearest tone ever been able to get."

"15% increase, when substituted for common strand copper wire."

"Over 100% increase, when connected to old set."

"900 miles with two 65 ft. strands, using detector tube and 2 steps of audio amplification."

"Cleverest aerial wire on the market."

At Your Dealers—or send us \$2.50 for 100 ft.

Dealers and Jobbers—Write for prices and terms.

SPRINGFIELD WIRE & TINSEL CO., 387a Main St., Springfield, Mass.

## Moulded-RADIO-Accessories

Manufactured of Approved Material

Specifications Solicited

Knobs  
Couplers

Dials  
Panels

Rotors  
Stators

## International Insulating Corporation

Radio Dept.  
25 West 45th St.  
New York City

Factory  
Springfield,  
Mass.

### REAL RADIO BARGAINS

RADIO SUPPLIES at lowest prices.  
WRITE TODAY. Send 2c stamp for catalog.  
Our Standard

QUALITY — LOW PRICE — PROMPT SHIPMENT  
APEX RADIO CO. 6914 S. Halstead St. CHICAGO, ILL.

Vesta "A" and "B" batteries for radio sets are noted for their long life.

# VESTA

COSTS LESS PER MONTH OF SERVICE

promising future ahead of them—far in excess of the old days—and their solidarity must be preserved. Sane and just working rules must be promulgated, each class to their period and the clash of spark and C.W. must be minimized if the radio fan and the spark amateur is to live. Already the balance has swung from an entire spark field to a preponderating C.W. field and the manufacturer ever ready to sell and thereby handsomely profit on the crest of the popularity wave is now pushing and will continue to push his products harder than ever, the WAVE is cresting over—will Mr. Amateur sit and see it not—will he let it engulf him or will he decide upon firm action to take him off the sands of inaction and build upon a rock of fixed principles, and higher standards of ethics, building it block upon block of united effort cemented with good will, public assistance and recognition?

That surely is THE only course of action—not by word but by deed and by proper publicity and generalship place before the Department of Commerce evidence that will compel enactment of laws vouchsafing his existence and a future to look forward to.

How this may be done is briefly stated in the following program:

1. Organization of an all embracing body of radio enthusiasts, national in its scope, properly generalised with men of high ideals for the radio future.

2. Strict rules of transmission and broadcasting inaugurated and sustained by Government authority.

3. Zones of operation coincident with time zones should be made to avoid serious local interference. Stations operating in the same district to be assigned wave lengths that will allow no conflict to ensue.

4. A standard of ethics should be formulated and enforced with a forfeiture of license upon violation of same.

5. Nationwide publicity should be given as to the real aim and endeavor of the amateur.

6. Broadcasting stations should be limited and selected according to a very high standard—similar to present Class B stations or perhaps improving on this. No commercializing of stations of all kinds should be tolerated.

7. A system of local, state and national policing co-operating with Government radio inspectors should be installed. Each to work definite areas and to report at stated intervals or as the occasion demands.

Of these the matter of publicity is one that radio fans and amateurs must foster—it is the squeaking wheel or bearing that gets the oil—let yourself be heard and due recognition will follow.

America in a greater extent has made radio what it is by producing men who did wonderful things for radio—these men were all real amateurs—and we must not by any means allow cutworms to sever the roots that these men have labored to produce so that an unfeeling public will transplant Mr. Amateur into an exclusive hot house class forever killing his chance to forge ahead and fill the niche which is his and should ever continue to be.

My plea is that everyone of you amateurs will wake up and see the opportunity that lies just ahead and let us not be swallowed by the wave that towers over our heads. WE CAN DO IT AND WE MUST.

### THIS IS NO JOKE.

Sergeant Lufkin of the Presidio was flirting with annihilation the other night:  
Lufkin (on wireless phone)—Hello, Bessey; Hello, Bessey; 6ZK, Bessey.  
Wife (standing near him)—Bessie who?  
The Sergeant—MISTER Bessey.  
Wife—Oh-



# Base Your Radio Outfit On This Supreme Dielectric **bakelite-dilecto!!**

[A Laminated Phenolic Condensation Product]

## XX Grade

Those who paneled their radio sets a year ago with "just anything that happened to be handy" are regretting it now.

Those who paneled with Bakelite-Dilecto, XX grade, will *never* regret it, for it will give everlasting service.

If you want satisfaction for all time, panel now with B-D XX. Nothing else has its many combined radio-advantages.

Handsome! Strong! Cannot warp, swell or crack. Resists heat, water, steam, fumes, mild acids and solvents. Readily machined. **GUARANTEED HIGHEST** in dielectric strength!

Put this in your mind—"Bakelite-Dilecto—**NOTHING ELSE WILL DO!**"

Your electrical dealer can get Bakelite-Dilecto cut and drilled to your specifications.

## The Continental Fibre Company

Factory: Newark, Delaware

*Dealers serviced from:*

New York, 233 Broadway  
Pittsburgh, 301 Fifth Ave.  
Chicago, 332 S. Michigan Ave.  
San Francisco, 75 Fremont St.  
Los Angeles, 411 S. Main St.  
Seattle, 91 Connecticut Ave.



# DREYFUSS HEAD SETS

The phones without distortion — ample volume. Designed especially for Radio-phone reception.

A quality product — only the best materials used. Compare favorably with any phone made.

**Prices**

- 1000 ohm Single type - - - \$4.75
- 2000 ohm Concert type - - - 8.00
- 3000 ohm Entertainment type - 12.00

**P. M. DREYFUSS CO., Inc.**  
150 Chambers Street New York, N. Y.

**Branches:**

- 179 Greenwich Street, New York, N. Y.
- 29 Cedar Street, Newark, N. J.

**OUR OFFER**

Use our phones 10 days. If not satisfied, return to us and we will refund your money.



## CHELSEA REGENERATIVE RECEIVER

A real Broadcast Receiver

Range 150 to 800 meters

- ¶ Perfection in design
- ¶ Pleasing appearance
- ¶ Simple and accurate tuning

\$40.00

A Chelsea product, embodying Chelsea equipment throughout. Licensed under Armstrong U. S. Pat. No. 1113149. For amateur use only.

Write for our new No. 7 catalogue

### CHELSEA RADIO COMPANY

179 Spruce Street

Chelsea, Mass.



### TRIUMPH

**No. 1A RADIO RECEIVING SET**

This highly sensitive vacuum tube receiving set combines high efficiency and scientific construction with greatest simplicity. This set embodies the famous "Triumph" combination Coupler-Meter which accomplishes the result of two instruments in one—also a 43 plate condenser of superior quality—a coupler dial guaranteed Socket and Rheostat, a hand engraved "Radion" Panel, guaranteed not to warp. The set is housed in a beautiful cabinet of solid mahogany or oak which will grace the finest surroundings. Size of set is 15 1/2 x 8 3/4, Height 7 in. List price \$30.00

Distributors wanted in every town. 64R UNIVERSITY PLACE NEW YORK

Write us for our interesting proposition. SIGNAL RADIO & ELECTRIC CORP.,

**VARIABLE CONDENSERS**

- 3-Plate Vernier .....\$0.75
- 23-Plate .0005 Mfd. .... 1.75
- 43-Plate .001 Mfd. .... 2.25
- 24-34-Plate Balanced Cond. .... 3.75
- 44-Plate Balance Cond. .... 4.75

Aluminum Plates, accurate spacing. Get these condensers and improve your set. Shaft runs in bearings. Money back if you are not satisfied.

MONTROSE MFG. CO.

1200 Bedford Avenue

Brooklyn, N. Y.

**CONQUEROR**

One Knob Control Radio Receiving Set

Write

**LEWIS & DEROY RADIO CORP.**

560 7th Ave., New York City

## Who Will Save the Radio Amateur

By FRANK H. FANNING

### Seventh Prize

Without a doubt it is up to the Radio Amateur to save himself; but how? That is the vital question.

Before we can get the answer to the "how" a little introspection is necessary. What is the cause of our trouble? Why are we losing our standing in the community? Why has the radio-phone public failed to take us seriously?

The answer is a simple confession. Too many of us are so selfishly wrapped up in the thrill of punching the key that we sit pounding out "CQ's and "tests" by the hour. We are not interested in a reply from some nearby amateur, but silently ignore him when he answers, and continue "CQing" in the hope that San Francisco or some distant station will answer, or send us a card. Listen in any evening and you will find fifty per cent of the QRM made up of such senseless piffle. Unless we take our game seriously how can we expect the radio public to consider us anything but a useless nuisance?

Another thing about us is that we are not willing to admit that with the present crowded condition of the ether, a radio-phone listener on every city square and in every farmhouse, the day of the spark set is gone. Too many of us stick to the old spark set because we like the noise she makes—as some fellows like to cut out the muffler on an auto or motorcycle. The crash of the jumping spark somehow gives us a sense of power that the silently operating tube set can never hope to equal.

If the radio amateur will get himself up to date with modern transmitting apparatus, see that it is properly adjusted, and tuned below 200 meters he has made the first step toward setting himself right with the public.

As a second step he must take himself and his transmitting privilege seriously. Cut out the useless QRM and operate the set only on legitimate work. By this I mean be sure that he is talking to someone when he punches the key. Prearrange a work period with someone, if necessary, but for the love of Pete don't use up ninety percent of the evening calling "CQ" at the whole U. S.!

The amateur will be blamed for interference by the radiophone listeners whether he is at fault or not. With his set scattered all over the house in the process of rebuilding he will be called on the telephone and told to get off the earth by local radiophone listeners. This is a fine opportunity to tell the radiophone "simp" what you think, but let me suggest that you hesitate. Say "cabbage" nine times to yourself before you speak, then with the utmost courtesy explain to him that he is possibly having trouble because several broadcasting stations are operating at the same time on 360 meters. Tell him your set is not operating at the present time; that you expect to be operating again soon, and want to arrange a time to test with him to see whether or not your set, adjusted below 200 meters, really would cause any trouble with the listeners on 360 meters.

This stunt has been worked with several radio listeners, and in each case they have reported "no interference." Needless to say, they are now friends and boosters. Equip your set with a phone, and frequently talk to the local listeners thus: "I am mighty glad to have your report Mr. \_\_\_\_\_ that my test is not in any way interfering with the broadcasting service, and would

like to hear from any other listeners as to whether or not they notice any interference from this test."

It pays to go out of your way to interest the radiophone listener in making this test. You have initiated him into the ranks of the experimenter, and he likes to talk about it to his fellow "bugs." If you have convinced him that your set will not interfere with the concerts he will boost you to all the other fans. Get several such boosters and you are beginning to "set solid" in the radio community. You won't be blamed for things you are not responsible for.

But what if your next door neighbor is a radiophone "bug?" Then I say the test is even more worth while. You must get him with you some way. Does he realize what the A. R. R. L. does in handling messages free? Get him interested in free message transmission. Get him to send greetings to his mother in a distant city, or to a friend across the continent. In small towns and cities some especially interesting relay stunt of this kind will be news for the local paper, and with the reporter giving you a writeup now and then, bringing in also the name of some citizen who has had a message relayed to some distant city, you have boosted yourself again.

It seems to me that this is one of our greatest opportunities to become recognized in the community as something better than a nuisance. I'll confess that I cannot see where the A. R. R. L. men get the thousand citizen messages a day to handle unless they originate them themselves. It is surprising how many are ignorant of this interesting phase of the radio amateur's work.

At this point it might be well for me to admit that I am not a member of the A. R. R. L. Why? Simply because I have never realized until lately what it meant to the amateur, and because the A. R. R. L. members whom I know have never advertised it, nor tried to sell the idea to me.

The organization of local radio clubs, bulletin service, and code practice nights for interested radiophone listeners are additional means to get the radiophone public with us.

Above everything else, we must get out of that narrow rut of selfish amusement, and start sharing our pastime with the uninitiated. We must be on the alert for ways to "sell" our services to him.

**WANTED—RADIO INSPECTORS**

The Government is holding an examination on March 7 for radio inspectors. Salaries run from \$1800 to \$2200 per annum, and the examinations can be taken in practically any large city by applying to the Civil Service Commission.

Men and women are eligible; over 21 years of age and under 50. The appointing officer reserves the right to specify whether he desires a man or woman.

Applicants must have a scientific degree from a school of recognized standing or the equivalent of a high school education and two years of radio work, and all must be radio operators.

The examination includes theoretical and practical questions in the construction, use and adjustment of radio apparatus and auxiliaries, counting 50 per cent. Education and experience in the line of duties constitutes the other 50 per cent. of the test.

The Department seeks to provide a list of available inspectors to take the places of inspectors who have resigned, but it is believed that the new radio legislation will require the services of some additional inspectors.

**TWO CLASS B APPLICATIONS**

The Memphis Commercial Appeal, of Memphis, Tenn., and Hale Brothers, at San Francisco, Cal., have applied for Class B licenses on 400 meters.

# D-X



## (DISTANCE) The Ambition of Every Amateur

**A GREAT ARRAY OF RADIO BARGAINS**  
Illustrated Free Catalogue Sent on Request. Remittance Must Accompany All Orders. No Checks or Stamps Accepted. Merchandise shipped post paid east of Mississippi. Our mail order department works quickly and without error. Drop your money order in the mail today.

**VERNIER VARIABLE CONDENSER**

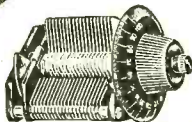

Finest Quality—Efficient—Accurate. Essential for D. X. work. Cap. .001 MFD. Reg. Price .....\$6.50  
Our Price .....\$4.55  
Other Variable Condensers of Best Hard Aluminum Plates—Condensite End Plates 1/4 in. Shaft

23 Plate .0005 MFD. Reg. Price \$3.50 Our Price \$2.25  
43 Plate .001 MFD. Reg. Price \$4.25 Our Price \$2.90

**C. H. VERNIER RHEOSTAT**

Genuine Cutler Hammer Product. Necessary for fine adjustment. Reg. Price \$1.50  
Our Price .....\$1.20  
Other Reliable Rheostats  
Fada Type Reg. Price \$1.00  
Our Price .....65c  
Plunger Type  
Reg. Price .....\$1.00  
Our Price .....65c

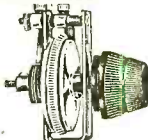

**FISCHER 180° VARIOCOUPERS RECOMMENDED**

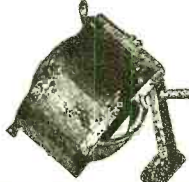

to Set Builders who desire distant stations. Equipped with Soldered Leads. Ready to Use. Reg. Price .....\$5.00  
Our Price .....\$2.95  
Fischer Variocouplers Range to 400 Meters  
Fischer Variometers Range to 400 Meters Soldered Leads. Ready to Use. Reg. Price .....\$5.00  
Our Price .....\$2.25

Fischer Variocouplers Range to 650 Meters.  
Fischer Variometers Range to 650 Meters.  
Soldered Leads. Ready to Use.  
Reg. Price \$6.00. Our Price .....\$3.25

**INDUCTANCE COIL MOUNTINGS**

Made of Prime Condensite Composition.  
Triple Coil Mounting—Reg. Price \$5.00. Our Price \$3.50  
Double Coil Mounting—Reg. Price \$4.00. Our Price \$3.10  
Single Coil Mounting—Reg. Price 30c. Our Price 50c.  
Reg. Price .....\$5.00



**INDUCTION COILS**

All Coils are Equipped with Standard Mountings

No.	Wave-Length	Price
25	125-250	\$1.35
35	175-450	.89
50	240-720	.95
75	390-910	1.00
100	500-1450	1.05
150	600-2000	1.15
200	900-2500	1.23
250	1200-3500	1.30
300	1500-4500	1.38
400	2000-5000	1.35
500	2800-6100	1.60
600	4000-10000	1.70
750	5000-12000	1.85
1000	7900-15000	2.21
1250	9750-19500	2.50
1500	14500-26500	2.60

Without mounting plus 60c less than price listed.

**INDUCTANCE SWITCH**



Mounts Switch Points and Contact Lever behind Panel. Only One Hole needed to mount on Panel. 15 Switch Points.

**SOCKETS**

Nickel-Composition Base. Most beautiful trimmings. Reg. Price .....75c  
Our Price .....40c



**MOLDED SOCKET Unbreakable**  
Reg. Price .....\$1.00  
Our Price .....50c

**GRID LEAKS**



We recommend SAFE-T Tubular Grid Leaks. They are unfailing, triple tested and accurate.  
3/8" — 1 — 1 1/2" — 2 — 2 1/2"  
3" — 3 1/2" — 4 — 4 1/2" — 5 MEG  
Reg. Price .....75c  
Our Price .....40c  
Fluewelling Fixed Condenser .006 MFD  
Reg. Price .....75c  
Our Price .....35c

**HEADPHONES**



James Ross of London Phones are designed for D. X. work and should be used for faint signals. Reg. Price .....\$10.00  
Our Price .....\$6.80  
Brandes Superior Matched Tone  
Reg. Price .....\$8.00  
Our Price .....\$6.50

**TRANSFORMERS**



Cardwell Audio Frequency Transformers are completely shielded for high amplification without distortion. Ratio 9 to 1. Reg. Price \$5.00. Our Price .....\$3.90  
Cardwell Radio Frequency Transformers are giving best results where long distance stations are desired—permit sharp tuning—do not require special hard tube. Reg. Price \$5.00. Our Price .....\$3.90

**D-X RADIO CO.**  
123 Liberty Street  
New York City

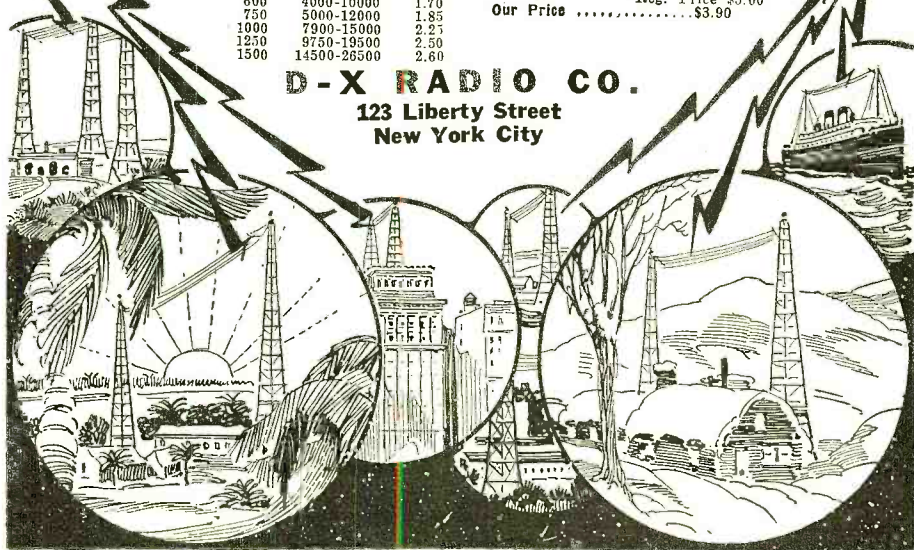

**RADIO**  **PRODUCTS**

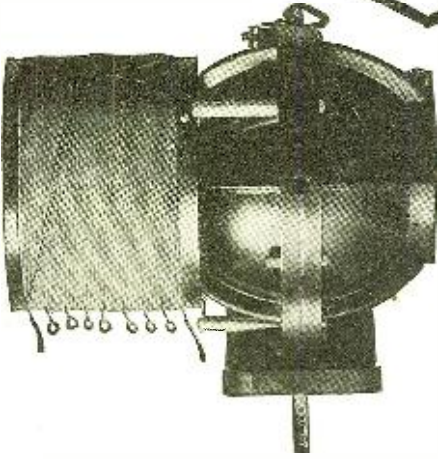

**SE-AR-DE Molded  
RADIOMETER**

*Build Your Own  
Single Circuit Tuner*

CATALOGUE No. 165

**\$13.00**

Range . . . . . 180-3100M  
" . . . . . 300-3280M

**R. MITCHELL & CO.**  
255 ATLANTIC AVENUE BOSTON, MASS.

TYPE  
V-310

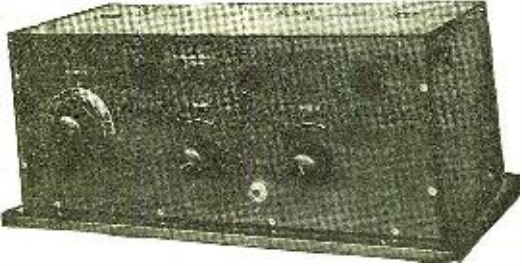

TYPE  
V-310

**THREE STAGE R. F. AMPLIFIED RECEIVER**  
For Loop Reception

Includes Three Stages of Radio Frequency,  
Tuning Condenser and Detector . . \$95.00

Write for Latest Circulars  
Dealers: Write for Discounts

199 So. Fair Oaks  
Avenue

**UNIVERSAL  
& RESEARCH CO**

Pasadena,  
Calif.

**Loud Speaker for any  
Crystal Set by using the  
Steinmetz Amplifier, \$8.50**

**NO STORAGE BATTERY  
REQUIRED**

Amplifying unit uses a Westing-house tube which requires only a single dry cell in place of the storage battery. Tube and batteries for this unit \$7.95. For a two-stage amplifier use two of these units. Amplifying unit sold knocked down for \$5.95. Hear the concerts all over the house.

**SUPERIOR CRYSTAL SET \$4.75**

STEINMETZ PHONES are of exceptional merit. 2000 ohms, \$5.00; 3000 ohms, \$6.50; single phone, \$1.75. Equal to any ten or twelve dollar phones made. Catalog 5c at your dealers or

**STEINMETZ WIRELESS MFG. CO.**  
Manufacturers and Engineers  
5706 Penn Avenue Pittsburgh, Pa.



**"PRECISION"**

**HIGH RESISTANCES 60c.**  
Ranging from .25 to 5 megohms. Made by specialists in this line for use in all Radio Circuits. Individually calibrated. Accuracy guaranteed. Lower values on order.  
12,000 ohm Resistance . . . . . \$1.00  
Mountings . . . . . \$0.50

**Radiophone Equipment Co.**  
47 New Street, Newark, N. J.

**Borrowing An Aerial**

(Continued from page 1638)

dow. I hooked the aerial and ground connections of my set to these two aerials and I had the surprise of my life. It worked splendidly! As a matter of fact, in this particular instance, it worked better than by using either of the aerials with the ground. I could tune just as well, or better, perhaps, than if I had used the ground, and the reception was exceedingly clear. Also, I found that as no ground is used I do not interfere with the owners. So I have in mind "borrowing" these two aerials continuously, every night.

I now have in the Patent Office an attachment that is entirely automatic. There is a selenium cell, and some other duffinies, most of which the amateur knows already. As soon as the light fades, selenium cell gets busy. An electro-magnet operates, and two lazy-tongs shoot out toward the two aerials, which are gripped pronto. An automatic connection is made somewhat along the lines shown in the illustration. This saves me the trouble of going fishing with a cane for the "aerials that pass by my windows." The first ray of sunlight which strikes the selenium cell, causes the lazy-tongs to be pulled back automatically, freeing the aerial so that if the owner looks up in the morning everything will be found as innocent as ever.

P. S. When using this system after a sleet storm, when the lazy-tongs are likely to freeze to the aerial, a pail of hot water thrown over the lazy-tongs will put them in operation again. (Patent Applied For.)

**Radio Digest**

(Continued from page 1631)

of the future sale of that type. No change in the design of any set or unit may be made after approval without the previous sanction of the Postmaster-General.

Note: The approval of the Postmaster-General does not carry any implied guarantee of the quality, workmanship or sensitivity of the apparatus.

Firms desiring to submit sets for approval and registration should send a sample set of each type together with relative wiring diagrams to the Engineer-in-Chief, Wireless Section, General Post Office West, London, E.C.1. After tests the firms will be notified of the result and advised that the sets are ready for collection.

**CAVITE TO WASHINGTON BY  
RADIO—FOUR MINUTES**

The transmission of a routine radio message from the Naval Station at Cavite, Philippine Islands to Washington, D. C., was accomplished recently by the Naval Communications Service within four minutes. The total distance was 11,500 miles establishing a new record for long distance land and trans-Pacific communication.

Ordinarily, with the delay on account of schedules, a message from Cavite to the Navy Department would not be delivered in less than several hours, and sometimes a whole day is required in the transmission, due to relaying, static, etc.

Of course the message was relayed at San Francisco where it was received from Cavite, but as the radio circuit to Washington was "set up" the message was relayed immediately. Within four minutes after the 16-word dispatch left Cavite, it

**MONEY for YOU** Add to your Salary—Make extra Pin Money. Start a lucrative business of your own. Spend an hour each day taking subscriptions for the "Radio News." We'll pay you well and you'll enjoy the work. Write for full particulars. Circulation Dept. RADIO NEWS, 53 Park Place, N. Y. C.

was received on the aerials on top of the Navy Building in Washington and read in the receiving room below. Radio communication is said to be instantaneous, and a signal is instantaneous, but a message is slower due to the fact that time is required to transmit it, record it, re-transmit and again record.

Westward, trans-Pacific Radio messages are relayed to Guam and Cavite through Honolulu. Recently through the operation of the Fanning electrical relay at Honolulu, 184 words were automatically relayed to Guam from San Francisco without being transcribed or re-transmitted, thus saving considerable time in their dispatch.

**DOCTORING BY WIRELESS**

A ship is a thousand miles at sea. No doctor aboard. Just seamen with a very limited knowledge of what to do in emergencies. One of the crew has a bad fall; gets up and goes about; eats a meal and later collapses. He seems to have a fit.

Ten years, five years, even three years ago he might have gone on having fits until he went down to Davy Jones locker, for all the help that could have reached him so far from land. But today the master of his ship sends a message by Radio to the nearest Public Health Hospital, in New York, or Boston, or San Francisco, as the case may be, describing his symptoms. The advice comes back. "Put the man to bed and keep him quiet, using morphine if necessary. Give light diet."

This revolution in the condition of men at sea was brought about by the Seamen's Church Institute of New York. On the roof of its sixteen story building there was a wireless room, where, in connection with the Navigation School, men were trained as operators. The inspiration came suddenly to the head of the Navigation School, Captain Huntington, to use this wireless station to send medical advice to ships at sea, carrying no doctors. He put the idea before Dr. Mansfield, Superintendent of the Institute, who was enthusiastic about it.

The experiment was tried but the instruments were too feeble to catch many of the messages. An appeal was sent out to the contributors of the Institute asking if someone would give five thousand dollars to purchase an outfit which would give the idea a practical tryout, and the late Henry Laughlin of Philadelphia responded. With the willing co-operation of the U. S. Public Health it was demonstrated that sometimes human lives, and generally much suffering could be saved by this direct communication with health centers. But obviously sickness and accidents overtook men beyond reach of New York by Radio. The business of the Seamen's Church Institute is less to build up a great institution than to make richer, and better and safer the lives of the men of the sea. Dr. Mansfield and the Board of Managers realized that this was something too important to confine to one port and the Radio Corporation of America and the U. S. Public Health were induced to take it over and make it national.

And that is how it has come about that any ship within reach of any station of the Radio Corporation of America can have free medical advice, within thirty to forty five minutes of the sending of the message. This applies to ships under any flag. It would not be in keeping with the spirit of America to ask, when a man was dying whether he was an American citizen. Belgians or Dutchmen or Scandinavians or Englishmen have only to ask help to receive it, and the funds of the public treasury might be less well spent than in broadcasting health to all the seamen of the world.

# GIBBLIN

## RADIO APPARATUS

Every product manufactured by us is the result of the inventive genius of Thomas P. Giblin. For years this master inventor has concentrated on the development of wireless telegraphy and telephony. The three leaders illustrated here are perfect in design and construction, and their performance is guaranteed.

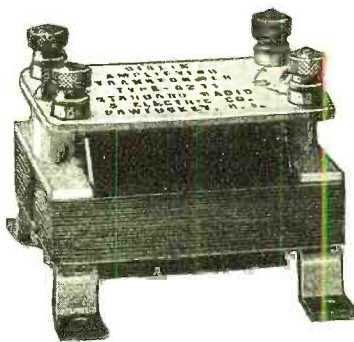

**Audio-frequency  
Amplifying Transformer**

This transformer has won the approval of radio enthusiasts from coast to coast. It is designed for use with standard amplifying tubes, and gives maximum amplification without noise or distortion. May be placed in any position without pre-magnetic coupling and squealing. Price mounted, \$4.50; unmounted, \$3.50.

**The "RADIOEAR"  
Vacuum Tube Receiving Set**

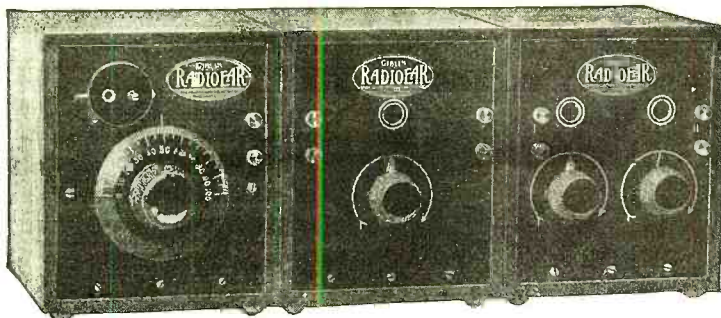

This set includes the new Giblin receiver, detector and two-stage amplifier. The single-control tuner is easily and quickly tuned with full efficiency on any wave length. Local and distant stations can be heard with perfect clearness. The amplifier secures maximum volume without distortion. For the average radio enthusiast, this set will do all that could possibly be desired. Price, \$50.00.

**Radio-frequency  
Amplifying Transformer**

Features: Simplicity of operation; elimination of static and interference; loop reception of signals made possible regardless of the distance of transmitting station; maximum amplification; maximum resistance without the use of iron; maximum coupling between primary and secondary winding; minimum of distributed capacity. Price, \$7.00.



Buy Giblin Radio products from your dealer.

Radio Department

**STANDARD RADIO & ELECTRIC CO.**  
PAWTUCKET, RHODE ISLAND

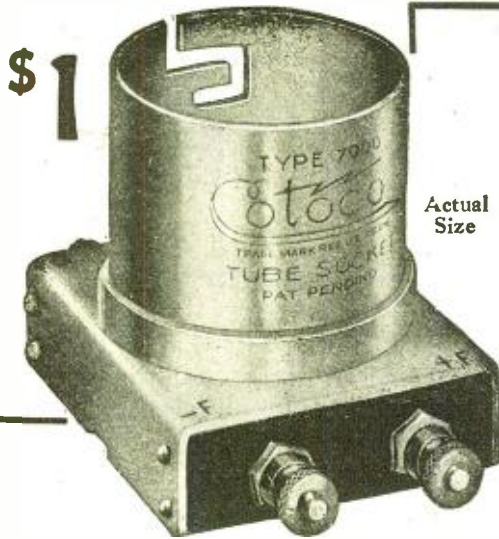

\$ 1

Actual Size

# O. K.

You will surely approve this Better Tube Socket because our Engineers have built into it five points of excellence. Read them. You Need them ALL.

1. Positive double side grip contacts. The Bayonet slot enables this.
2. Hard rubber insulation assures a minimum of losses.
3. Rugged construction. Practically unbreakable.
4. Compact design permits close assembly.
5. Heavily nickeled for neat appearance.

**COTO-COIL CO.**

87 Willard Ave., Providence, R. I.

If Your Dealer can't show the Cotoco Double Bayonet Slot Action, Make him write us today for Dealer's Sample

## QUALITY AMPLIFICATION

In our previous advertisements we have outlined the fact that we were the first company to have available for the experimenter a closed core amplifying transformer.

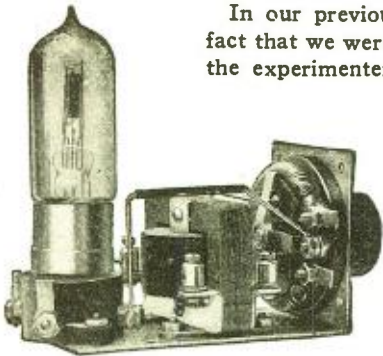

We also called attention to the fact that we have maintained a research laboratory for many years for the study of radio problems.

We now announce a new quality instrument. It is an amplifier unit for the WD-11 tubes. The unit is complete ready for tube and batteries. It may be mounted on a table or behind a panel, in which case only the rheostat knob projects.

*A quality instrument at a fair price!*

Price .....\$7.50

SEND FOR FREE RADIO BULLETIN 913N

# GENERAL RADIO COMPANY

Massachusetts Avenue and Windsor Street

CAMBRIDGE 39

MASSACHUSETTS

*Standardize on GENERAL RADIO COMPANY equipment throughout—*

DO NOT CONFUSE the products of the GENERAL RADIO CO. with those of other concerns using the words, "General Radio." The GENERAL RADIO CO. has been manufacturing radio and scientific instruments for many years. It has no affiliation with any other company.

## Amsterdam Service Exchange

AMSTERDAM  
O H I O



**SHEETS  
RODS  
TUBES  
Specialties**

**SPAULDINGS BLACK**  
fibre for panels and other exposed parts.  
**SPAULDINGS SUPER GRAY** for interior parts.

**J. SPAULDING & SONS CO., Inc.**  
New York 484 Broome Street  
Boston 14 Elkins Street  
Philadelphia 141 North 4th Street  
Chicago 659 West Lake Street  
Tonawanda New York

## BROADCASTERS DELETED FROM BUREAU OF COMMERCE LISTS.

In December the following 20 broadcasters were dropped from the rolls of the Radio Lists:

- WLAD—Arvanette Radio Supply Co., Hastings, Nebr.
  - WAAV—Athens Radio Co., Athens, Ohio.
  - KFBJ—Boise Radio Supply Co., Boise, Idaho.
  - WKAM—Breede, Adam, Hastings Daily Tribune, Hastings, Nebraska.
  - WJAH—Central Park Amusement Co., Rockford, Ill.
  - WMC—Columbia Radio Co., Youngstown, Ohio.
  - WCAZ—Compton, Robert E., Carthage, Ill.\*
  - WAAG—Elliot Elect. Co., Shreveport, La.
  - WCJ—Gilbert, The A. C. Co., New Haven, Conn.
  - WDAN—Glenwood Radio Corporation, Shreveport, La.
  - WAAR—Groves-Thornton Hardware Co., Huntington, W. Va.
  - WFAR—Hall & Stubbs, Sanford, Maine.
  - KDYR—Pasadena Star-News Pub. Co., Pasadena, Calif.
  - WPAN—Levy Bros. Dry Goods Store, Houston, Texas.
  - KGF—Ponoma Fixture & Wiring Co., Ponoma, Calif.
  - WAAO—Radio Service Co., Charleston, W. Va.
  - KFBA—Ramey & Bryant Radio Co., Lewiston, Idaho.
  - WJAC—Redell Co., The, Joplin, Mo.
  - KYF—Thearle Munio Co., San Diego, Calif.
  - WIAA—Waupaca Civic & Commerce Ass'n., Waupaca, Wis.
- \*(New license and call WRAM, December 29.)

## BROADCASTERS LICENSED ON 360 METERS

- WPAS—J. & M. Electric Co., Amsterdam, N. Y.
- WPAP—Theodore D. Phillips, Winchester, Ky.
- WPAQ—General Sales & Eng. Co., Frostburg, Md.
- WPAU—Concordia College, Moorhead, Minn.
- WWAD—Wright & Wright, Inc., Philadelphia, Penn.
- KFEP—Radio Equipment Co., Denver, Colo.
- KFHJ—Fallon Co., Santa Barbara, Calif.
- WQAL—Cole County Tel. and Tel. Co., Mattoon, Ill.
- WPAK—No. Dakota Agricultural College, Fargo, N. D.
- WPAT—St. Patrick's Cathedral, El Paso, Tex.
- WPAH—Wisconsin Dept. of Markets, Waupaca, Wis.
- WOAY—John W. Wilder, Birmingham, Ala.
- KFDH—Univ. of Arizona, Tucson, Ariz.
- WRAM—Compton, Robert E., & Carthage College, Carthage, Illinois.
- WQAC—Gish, E. B., Amarillo, Texas.
- WPAW—Radio Installation Co., Inc. Wilmington, Del.
- KFCM—Richmond Radio Shop, Richmond, Calif.
- WPAX—S-W Radio Co., J. R. Shumate, Jr., Thomasville, Ga.
- WPAV—Tinetti & Sons, Paul, Laurium, Mich.
- KFAZ—Weatherell, C. H., Reddley, Calif.

## ONE MORE CLASS B ON 400

WCAE—Kaufman & Baer Co., Pittsburgh, Penn.

Get a Handy Binder for your RADIO NEWS. Holds and preserves six issues, each of which can be inserted or removed at will. Price 65c. Experimenter Pub. Co., Inc., Book Dept., 53 Park Place, New York.



### COURIER JOURNAL RETURNS TO 360 METERS

One big broadcasting station after trying out the Class B license on 400 meters for a short time has returned to the 360 wave. The Department of Commerce has just relicensed WHAS. The Louisville Courier Journal, on 360 meters. That paper believes the 360-meter wave is better suited for its broadcasting, and more popular with the fans.

### NEW SIGNAL CORPS RADIO EQUIPMENT IN ALASKA STATIONS

Radio is slowly supplanting government lines in the great reaches of the Yukon.

The first radio station erected in any United States possession to handle any commercial business was built in 1903 at St. Michaels in Alaska. Radio then reached to Nome replacing many cables and wires. Winter ice across Norton Sound was constantly carrying the 100 mile cable away and its replacement was expensive, so the stations at St. Michaels and Nome were erected and are still in operation. Later on more stations were erected, chiefly in the interior, until fifteen spark stations were completed.

#### ARCS AND TUBES REPLACE SPARK SETS

During the past summer all these stations were modernized. All spark sets were replaced with arc sets, at important points and with tube transmitters at the smaller stations. Today there is not an army "spark" in Alaska. The modern equipment, is estimated, will save about 75 per cent of the old operation costs and improve the transmission materially.

Signal Corps radio operators are now working direct from Fairbanks to Nome a distance of about 540 miles by radio.

### VULCANIZED FIBRE IN RADIO APPARATUS.

Every manufacturer is primarily interested in the cost of his raw materials. To makers of radio apparatus, who are of necessity limited in their choice of materials to the comparatively high priced products which their own exacting manufacturing requirements demand, this subject is of particular importance. There is on the market vulcanized fibre manufactured for electrical purposes. It comes in four colors—Red, Black, Gray, or "Natural," i. e. of hard boney appearance, and the adaptability of this interesting and frequently overlooked product is best illustrated by the following list of physical properties shown by an average grade of fibre 1/8" thick.

Hardness by sclerometer.....	35
Shearing strength, lbs. per sq. in.....	13,000
Crushing " " " " ".....	43,000
Tensile " " " " ".....	13,000
Breakdown voltage " " " " ".....	25,000
Combustion point	650 degrees Fahrenheit.

Manufacturers of all but the most expensive types of receiving sets might find the use of black fibre panels to be advantageous. Fibre takes an excellent finish when buffed or polished and shows no tendency to warp when secured to the cabinet. Fibre sub-panels are used in a number of sets of the vacuum tube type and form an excellent base upon which to mount the various instruments.

Rheostats and potentiometers of the wire wound type generally use vulcanized fibre as a support upon which to wind their resistance wire. The fibre will bend very readily around the small radius necessary for the compact instrument and its combustion point of 650 degrees Fahrenheit is

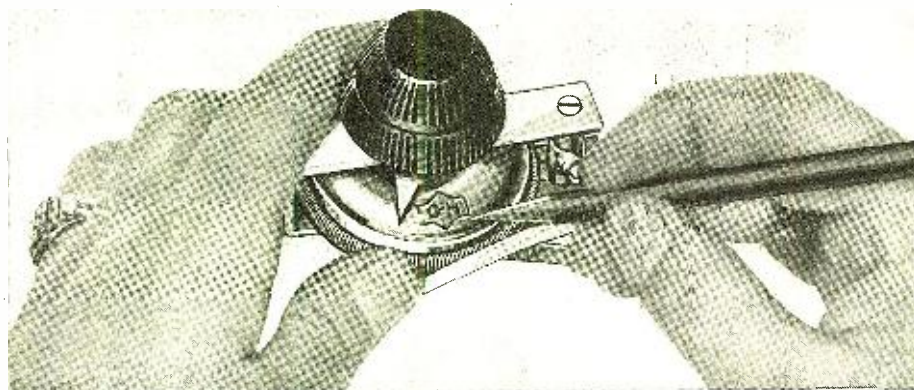

## The Trademark That Says "Built by the Master Builder"

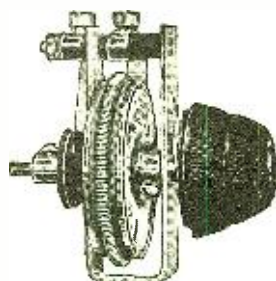

**C-H Vernier Rheostat**  
Perfect control for the detector tube. Stepless resistance, 0 to 4 ohms. Finished in ebony black and satin nickel. Panel mounting, positive travel stops, "full off" and "full on" positions.  
Type 11601-H1 \$1.50

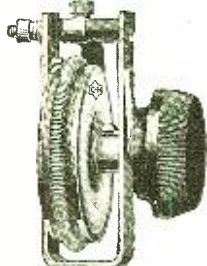

**C-H Radio Rheostat**  
Without vernier for amplifier tube control. Single, comfortable knob of genuine Thermoplas. Great number of small turns give fine control.  
Type 11601-H2 \$1.00

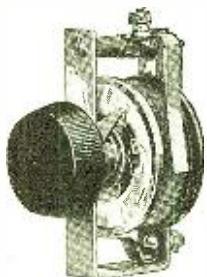

**C-H Radio Potentiometer**  
A superior potentiometer, of the revolving drum type. Matches exactly the C-H Radio Rheostats in performance and appearance. Construction assures consistent, accurate operation—resistance element cannot be displaced and is subjected to minimum wear. Range provided: 0 to 300 ohms.  
Type 11602 \$1.50

For more than thirty years, the engineers of Cutler-Hammer have been the aggressive pioneers in the development of rheostatic control.

They have carried their art into every industry—have made possible many of the modern miracles of electrical production, and their signature of approval, the C-H trademark, is a guarantee demanded by engineers throughout the entire world.

This same confidence in the product of the specialist has been appreciated by the buyers of radio equipment. In little more than half a year, over one-quarter million radio rheostats protected by the C-H trademark have been installed in the receiving sets of America.

You should demand this same protection in the three vital parts of your receiving circuit. The C-H Radio Rheostat for amplifier tube control, the C-H Vernier Rheostat for detector tube control, and the C-H Radio "A" Battery Potentiometer all are engraved with the trademark that says "Built by the Master Builder." They are carried everywhere by reliable electrical and radio dealers and jobbers.

**THE CUTLER-HAMMER MFG. CO.**  
Member Radio Section, Associated Manufacturers of Electrical Supplies  
MILWAUKEE - WISCONSIN

"Built by Rheostat Builders"

# CUTLER-HAMMER

## LISTEN IN!

Big news for all radio enthusiasts. The price of the Dictograph—the supreme radio headset—has dropped \$4, a clean third of the regular price. The world's best headset is now within everybody's reach. Intensive production to meet the enormous demand has effected a great manufacturing economy. We are allowing you the saving. Take advantage of this wonderful opportunity to save \$4 on the best headset in the world.



### DICTOGRAPH Radio HEAD SET

Was \$12—Now \$8

This is the same supreme Dictograph Headset that has always sold for \$12—(3000 ohms)—same in quality, same in guarantee, same in everything but the price—\$8 complete. Made by the makers of the world standard Dictograph products—the marvelous "Acousticon" for the Deaf, the famous Detective Dictograph, the Dictograph System of Loud Speaking Telephones and the Dictograph Radio Loud Speaker for the Home.

The Standard of the World

Dealers: Order through your jobber or write for names of authorized distributors.

THE DICTOGRAPH PRODUCTS CORPORATION  
220 West 42d Street Suite 1301 New York City

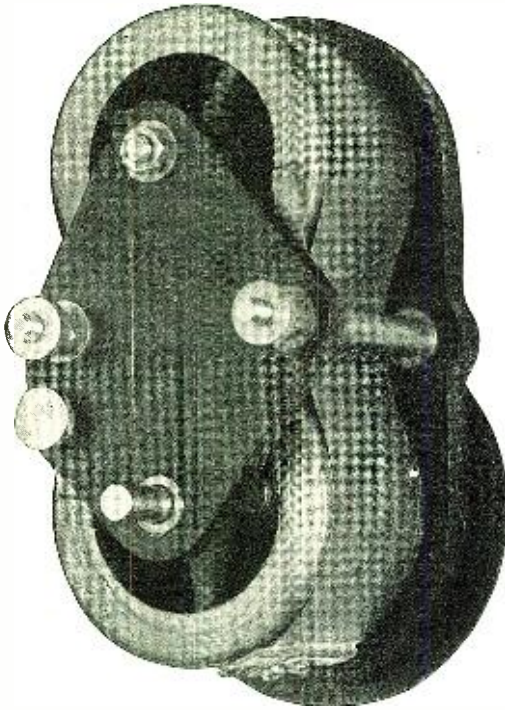

### BROOKS VARIABLE CONDENSER

Two Ribbons furnished  
Easily interchangeable  
(Max. .0005—Min. .00001)  
(Max. .001—Min. .00001)

Adaptable to all receiving circuits.  
Shorting of plates eliminated.  
Nicety of adjustment.  
Straight line capacity curve.  
Low internal resistance.  
Loud Signals.

Jobbers Wanted:  
Write for prices and discounts.  
Retail Price, \$4.75 each  
Complete with dial.

Manufactured by  
**Metric Metal Works**  
of  
**American Meter Co., Inc.**  
ERIE, PA.

**DEALERS:—**  
WE are Jobbers for  
*Grebe Receiving Sets*  
*Murdock Products*  
*Baldwin Phones*  
*Federal, Fada and*  
*Radio Shop Products*  
Write for Our Special Proposition A

**The Radio Shop**  
OF NEWARK  
76 Springfield Ave., Newark, N. J.

## RUSONITE

CRYSTAL RECTIFIER

MULTIPOINT (Patent Pending)  
A Synthetic CRYSTAL DETECTOR  
sensitive over its entire surface.

Eliminates all detector troubles. Extraordinary clearness and volume. Endorsed by Radio experts and press. Sold in Sealed Packages only. Join the ever increasing Rusonite fans.

Price, Postpaid, mounted **50c**  
Sensitivity guaranteed

**RUSONITE CATWHISKER**  
14 Karat Gold Multiple Contact Super Sen-**25c**  
sitive

Order from your dealer or direct from us  
**RUSONITE PRODUCTS CORP.**  
15 Park Row, N. Y. Dept. "N"

### A Selective Multi-Range Regenerative Receiver

(Continued from page 1641)

tainty as to the proper method of wiring the rotor the constructor should make these leads with temporary wiring and test for oscillation. If oscillation is not obtained in one direction the two leads to the rotor should be reversed.

The wiring should be made with hard-drawn copper wire. The buss-bar method is the simplest and most efficient. It is not necessary to use insulation if tinned wire is employed. All joints should be carefully soldered.

**METHOD OF OPERATION**

The operation of this receiver is somewhat more complicated than the direct-

**HAVE YOU SOMETHING TO SELL OR EXCHANGE?**  
A classified ad in RADIO NEWS will reach over 225,000 at a cost of only 15 cents a word

coupled type but can easily be mastered. It should be remembered that there are two separate circuits to be tuned to the incoming signal, the antenna circuit and the secondary circuit.

Referring to the front view of the receiver, the antenna circuit is tuned by means of the first inductance switch and the dial at the extreme left which controls the condenser in series with the antenna circuit. The secondary circuit is tuned with the second inductance switch and the dial at the extreme right controlling the condenser across the secondary circuit. The left-hand center dial varies the coupling between the primary and secondary circuits while the right-hand center dial controls regeneration or produces oscillation.

To pick up a signal or while "standing by" the coupling between the primary and secondary circuits should be at maximum and the two circuits tuned to the approximate wave-length to be received. After a signal is picked up and it is desired to exclude other stations which may be interfering the coupling should be decreased and corresponding adjustments made of the two circuits.

For example, to pick up a broadcasting station on 360 meters the two inductance switches should be turned to the fourth or fifth stops, the coupling dial turned to the maximum position and the rotor of the second coupler turned until the circuits commence to oscillate. The extreme left and extreme right dials should then be revolved simultaneously until the heterodyne whistle of the transmitting station is heard. The "tickler" should then be decreased until the circuits stop oscillating. If finer adjustments are then made with both tuning condensers and the tickler the signals will be loud and clear. In most cases it will be unnecessary to make further adjustments but if interference is present the circuits can be made more selective by reducing the coupling between the primary and secondary circuits with the left-hand center dial. As the coupling is reduced further tuning of both circuits with the two condensers and adjustment of the tickler coil will be necessary until a degree of coupling is obtained when the interfering signal is excluded and the desired signal properly tuned. A record can be kept of the best positions of all the tuning elements for particular stations and these stations can then be easily tuned in at any time.

In concluding, the writer wishes to record the unusual qualifications of a Western Electric VT2 tube as a detector and oscillator in a circuit of this type. It functions extraordinarily well with a plate voltage of from 45 to 75 volts.

### Pointers In Operating Vacuum Tubes

(Continued from page 1641)

breaks at these boundary or cleavage lines. These cleavage lines where the separate blocks of the wire seem to be joined are the weak links in the filament, and the brittle form is therefore apt to burn out or be damaged more easily at these points.

Now what makes an ordinarily ductile tungsten filament wire brittle? The filament as it comes from the factory is usually in the ductile form, as shown by microscopic examination. Now experiment shows that if this ductile filament is taken and heated at its proper operating temperature, or over, it still retains its ductile form. This is shown both by microscopic examination and by bending the wire after burning as above, when the wire does not break, but bends easily, thus showing that it still is in ductile form. Now if this very ductile

# ATWATER KENT RADIO EQUIPMENT

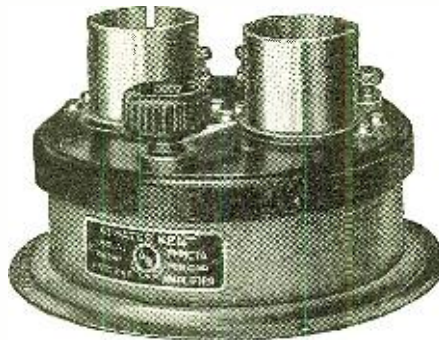

The 2-Stage Amplifier unit is not limited to any particular type of circuit, but is universally adaptable to any set-up requiring an audio-frequency amplifier. It is a compact, ruggedly constructed amplifying unit.

2-Stage Amplifier—\$14.00

A similar unit is furnished in a Detector 1-Stage Amplifier at \$13.00.

Maximum volume without sacrificing clearness of tone. Rigid construction and compactness. Hermetically sealed, absolutely no moisture troubles. The instrument was submerged in water 24 hours, taken out and placed in same circuit with results standard in every way.

Detector 2-Stage Amplifier  
\$16.50

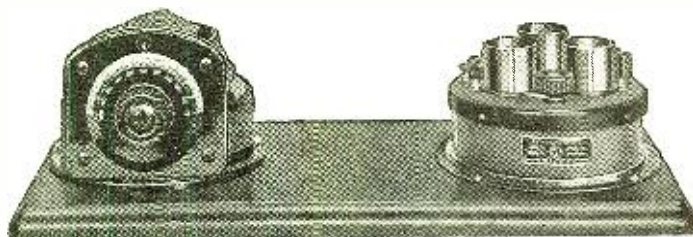

The above set, consisting of Coupled Circuit Tuner and Detector 2-Stage Amplifier, is an ideal set for either phone or loud speaker use. Note that this set includes two stages of audio-frequency amplification.

Complete Outfit, as above, wired \$35.50

Other sets, mounted and wired, are furnished as follows:—

Coupled Circuit Tuner and Detector 1-Stage Amplifier \$32.00  
Coupled Circuit Tuner and Detector Unit \$23.50  
Coupled Circuit Tuner, Detector Unit and 2-Stage Amplifier \$37.50

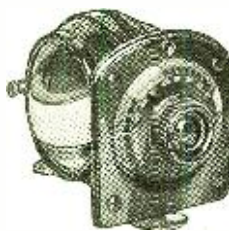

The Mounted Variometer carries through the standard quality of ATWATER KENT products. For an open set it supplies a finished instrument unsurpassed in appearance and performance.

Mounted Variometer . \$10.00

An Excellent Merchandising Proposition.

ATWATER KENT MANUFACTURING COMPANY  
4943 STENTON AVENUE Radio Dept. PHILADELPHIA, PA.

### "United" Variable Condensers Are "Just About Perfect"

In outward beauty—with cleancut hard aluminum plates, ebony Bakelite ends, highly finished nicked parts and, in the "beautiful" work—they do, "United" Condensers are as near 100% good as can be imagined.

- |                 |                |
|-----------------|----------------|
| 43 plate \$4.50 | 5 plate \$2.75 |
| 33 plate 4.00   | 3 plate 2.25   |
| 11 plate 3.50   | postpaid       |

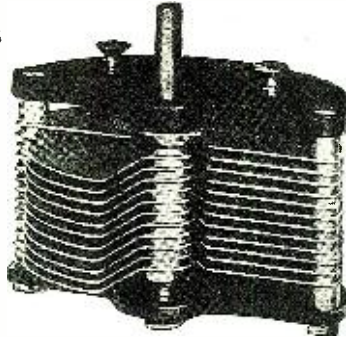

### "United" Audio Frequency Transformers



"Staple as Wheat" in the Radio industry. Magnetically shielded in a shell of original design and finish—a beautiful piece of workmanship. Ratio 5 to 1. Insures loud, clear signals. Fully mounted.

Price postpaid ..... \$4.50

Send for our 1923 Bulletins

**United Mfg. & Distributing Co.**  
536 Lake Shore Drive, Chicago

filament is burned at red heat or below its proper operating temperature, a great change will take place. Bend the wire now and it breaks easily. Examine it under the microscope and the wire is shown to be now in the brittle form with its blocks and definite boundary and cleavage lines. Still another experiment performed proves this. Take a ductile filament wire and gradually increase the current by cutting out your rheostat as so many operators do, and thus raise the temperature to its proper operating value. Examination and test again show that the wire has changed from the ductile to the brittle form. In other words these tests have shown that operating filaments made of tungsten, at temperatures below their operating values will result in deterioration of the filament due to formation of a brittle or crystalline structure.

Thus these researches have definitely proved that far from increasing the life of the tube, operation at low temperatures has the effect of decreasing the life due to fundamental changes which take place in the structure of the wire. These facts are apparently well known to the electric lighting companies. For when one turns on the electric lights in one's house the entire lighting current is flashed on the lamp, and no resistance is varied. And in spite of this, incandescent lamps last a pretty long time. If the same procedure were followed in operating vacuum tubes a marked increase in tube life would result. Once you have adjusted your filament rheostat at the proper operating position, it should be left there and the current simply applied whenever the set is started up. The only time the filament rheostat should be varied is for necessary fine adjustments which have to be made from time to time, and for compensation of any battery voltage variation. But otherwise the rheostat should be left at the last operating position.

Stress is laid on this particular point in vacuum tube operation because it is generally neglected and has not been brought out very much in publications. The operator is liable to lay too much stress on not overloading his tube filaments, meanwhile overlooking the equally important fact that underloading the filament is equally injurious and detrimental to long tube life.

You pay 2 much when you spend \$6 or \$8 for Moulded Variometers or Couplers

## SPECIAL OFFER 2 Variometers \$15.25 1 Coupler

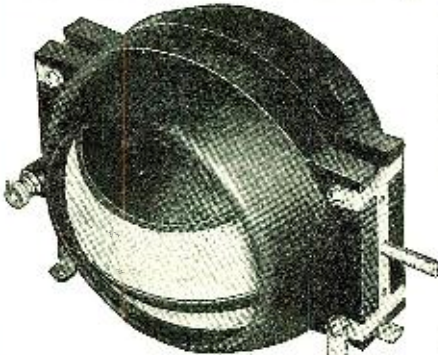

### Moulded Variometers \$5.50

**VARIOMETER.** The stators and rotor are moulded of hard rubber, and are highly polished. Green, double silk covered wire used. All parts nickel plated. Clearance between rotor and stator is .0005 with a + or - of .0002 either way. Large dimensions permit the use of low resistance wire. No paraffin shellac are used in wiring. Shaft  $\frac{3}{8}$ " or  $\frac{1}{4}$ ". Wave length 150 to 650 meters.

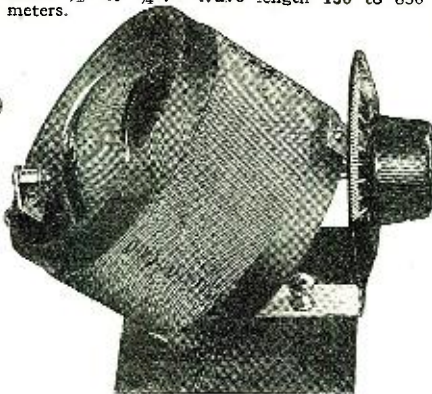

### Moulded Couplers \$5.00

**COUPLER.** 180°. Rotor moulded of hard rubber, all windings of green double silk covered wire. Primary tube made of high dielectrical composition of  $\frac{1}{8}$ " thick mounted at 45° angle, adapted for base or panel mounting. Shaft  $\frac{3}{8}$ " or  $\frac{1}{4}$ " nickel plated finish. Primary wound with 50 turns of wire tapped every fifth turn. Effective tuning range 150 to 650 meters.

We pay transportation charges. If you are not satisfied in every way with our equipment, return it at once and we will refund the purchase price.

**RADIO INSTRUMENT and PANEL CO.** 26 N. DESPLAINES ST. CHICAGO, ILLINOIS

## A "B" Battery Fuse

(Continued from page 1625)

battery inadvertently get into the filament circuit.

Being unable to find a bit of small fuse wire, we substituted thin tinfoil in the following way: Cut a small block of bakelite about 2" x  $\frac{1}{2}$ ". Bore a hole in each end and mount a binding-post having a metal base-lug. A strip of thin tinfoil is then placed in position as shown in Fig. 1 and

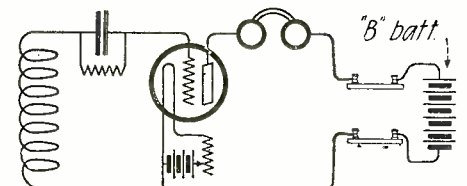

Fig. 1. General Appearance of the Completed Fuse. The Dotted Lines Show Where the Tinfoil Is Cut. Fig. 2. Showing How the Fuses Are Connected in a Circuit.



"True-Tone"  
SUPERSENSITIVE  
3000 Ohms

The Only Quality  
3000-Ohm Guaranteed Head Set for  
\$5.00

**TRUE - TONE RADIO MFG. CO.**  
188 No. La Salle Ave. CHICAGO, ILL.

GIVE YOUR EARS A TREAT!—USE  
**"RED-HEADS"**  
3000 Ohms  
Now \$6.50  
With Military Head-Band and Cord  
At your dealers or direct on receipt of price.  
A Triumph in Radio, Receiver Design  
**The Newman-Stern Co.** Newman-Stern Building Cleveland, O.

WANTED—Back numbers of Radio News, Sept., Oct., Nov. and Dec., 1921, Jan. and Feb., 1922. Experimenter Publishing Co., 53 Park Place, New York City.

the base lugs fastened down to hold it in place. With a sharp-pointed knife cut away the tinfoil as shown by the dotted lines, leaving a very narrow strip of metal. This will give you a fuse that will blow on a very small current.

One such fuse should be placed in each "B" battery lead, as shown in Fig. 2. If amplifiers are used, additional fuses should be made, one for each such "B" battery connection.

With such devices in place the writer does not hesitate to mix up his connections. With 45 and 90 volts of "B" battery on the table he has never burned out a tube. Once in a while a new piece of tinfoil has had to be put in place; but any ham will admit that this is far less expensive than replacing one and sometimes a battery of two or more VT's.

### Getting out "Radio News"

(Continued from page 1660)

If we do print them, the paper is filled with junk.

If we knock spark sets, amateurs say we don't know what we're talking about.

If we boost C.W. sets, they say we're visionary.

If we try to uplift the amateurs, they say we do it for monetary reasons.

If we tell the unvarnished truth, they say we are knocking and deserting them.

Like as not you will say we swiped most of this from another magazine.

We did.

### I Want to Know

(Continued from page 1664)

#### SUPER-REGENERATIVE DATA.

(633) Mr. Ainley Wochr, Geneseo, Ill., wants to know:

Q. 1. In the Armstrong super-regenerative circuit, does the grid and plate coils of the second tube remain the same when wave-lengths over 360 meters are received?

A. 1. Yes, these coils are not changed for any wave-length. The "super," however, will not work efficiently above 600 meters.

Q. 2. Is the first tube a hard or soft tube?

A. 2. All tubes used are amplifying, or hard tubes.

Q. 3. In the circuit using two tubes can the plate battery be about 50 volts instead of 160?

A. 3. Yes, 50 volts can be used, but the volume of sound will not be as great as when 100 volts or more are used.

#### DECREASED SIGNAL STRENGTH.

(634) Mr. Geo. Smith, Brooklyn, N. Y., writes:

Q. 1. I have had my set in operation for about a year and have had very good results, having received 1500 miles. Lately, however, the long distance stations are very weak, and many of them cannot be received at all. The "A" and "B" batteries are fully charged.

A. 1. If you have your antenna strung over the house tops, it has no doubt become oxidized badly on the outside of the wire due to the smoke from chimneys, etc. As the high frequency radio waves travel on the outside of a conductor, and as the oxidization, although a conductor, has a very high resistance, you will readily see that any weak signals would be lost before they reached the tuner. We would advise you to put new wire in your antenna or clean it thoroughly. It may be that you have not soldered your joints from the antenna to the lead-in wire, and there is a bad connection.

#### HOW A VACUUM TUBE FUNCTIONS.

(635) Mr. Alfred Brown, Chicago, Ill., wants to know:

Q. 1. How does a vacuum tube function? Explain in detail how it works.

A. 1. A vacuum tube contains three elements, filament, grid and plate. The plate and filament are separated by the grid. When the filament is heated to incandescence, it gives off electrons which are of negative polarity, and if a battery is connected with the positive side to the plate and the negative side to the filament, current will flow from the plate to the filament. In other words, the negative electrons furnish a path for a positive current to travel over. If a negative charge is impressed on the grid it will have the tendency to check the negative electrons from the filament, thus decreasing the current flow from

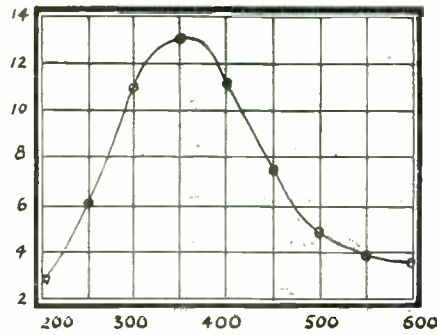

CHART I

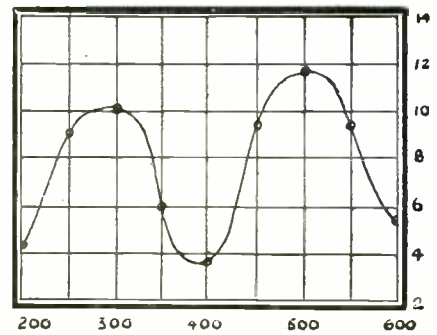

CHART II

## The importance of uniformity

### How to avoid amplification losses when using radio frequency

**B**EFORE you purchase a radio frequency transformer be sure to find this out. Does it show marked depressions and peaks in the amplification range between 200 and 600 meters? No amplification is possible in such depressions. Getting distant stations becomes a gamble as to whether or not there is any amplification at a given point.

#### How to get uniformity

**T**HERE is a radio frequency amplifying transformer which has been so perfected that the peaks and depressions are eliminated. This is the Acme R-2. This unique transformer, after long-months of experimentation, has been perfected with a special type of iron core and windings which eliminate the peaks and depressions and provide a steadily increasing volume of amplification up to the point of maximum importance—360 meters.

#### Gets greater distances

**E**QUALLY important is the far greater distances you get broadcasting. The Acme R-2 used in a radio frequency amplifier builds up wave energy before passing it on to the detector. You hear signals ordinarily inaudible.

The simplest and most elementary type of set, either vacuum tube or crystal receiver type, will have its range tremendously increased.

#### The best method

**T**O SECURE maximum results use three stages of Acme Radio Frequency Amplification (R-2, R-3 and R-4), a crystal detector and three stages of Acme Audio Frequency Amplification. This insures maximum sensitivity and intensity, quietness in operation and freedom from distortion. A small indoor antenna or loop may be used and sufficient intensity obtained to operate the Acme Kleerspeaker, providing

perfect entertainment for a roomful of people.

You can get these and other Acme Products at radio, electrical and many hardware stores.

Write for booklet R-2 showing proper hook ups and other information.

#### THE ACME APPARATUS CO.

Pioneer transformer and radio engineers and manufacturers

CAMBRIDGE, MASS., U. S. A.  
New York, 1270 Broadway  
Chicago, 184 W. Washington St.

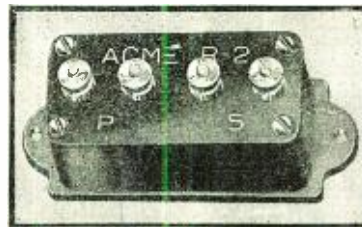

Acme R-2 Radio Frequency Amplifying Transformer. Price \$5.00 East of Rocky Mountains

# ACME ~ for amplification

## Do Your Own Battery Charging Use a Leich Non Tune Radio Rectifier



for Long Life and Satisfactory Operation. Used by the Big Trunk Line Railroads for Block Signal and Interlocking plants.

Will operate over wide range of voltage and frequency variation because it is not tuned to one particular frequency.

Charge radio batteries at night—Cost equivalent to burning a 40 watt lamp. Relay lock positively prevents discharge of battery due to power failures.

There are no expensive parts on a Non Tune to wear out. We limit the current output to a point where maximum efficiency and long life is obtained.

Manufactured for both 60 and 25 cycle alternating current.

Ask your dealer or write for Bulletin 100-C

**LEICH ELECTRIC CO., Genoa, Ill.**

the plate. If a positive charge is impressed on the grid it will increase the electronic flow. As the received signals are in the form of alternating current the grid will be charged alternately negative and positive, which will control the "B" battery current flow from the plate, and if a phone is connected in series with the battery the fluctuations of the current will produce an audible sound therein.

## At A Radiophone Party

(Continued from page 1635)

from Pittsburgh or wherever we was switched to by that time was a reading from Shakespeare by one of these here gal elocutionists, and this seemed to be the real bed time story of the evening or at least I noticed pretty near everybody in our party acting kind of sleepy before she was half-way through with it.

Well they tell me around here that the theatre managers and opera managers and &c. is kind of leery that the radio folks will sign up some of the star song birds and comedians and &c. and the next thing you know these people would be singing or springing their gags to a audience of 2 or 3 million people a night without the audience paying a penny to hear them and in the case of most of the divas and tenors why you could enjoy them a whole lot more if you didn't half to look at them while they was singing. This is what made grand opera gramophone records so popular.

Well the time may come when they will have entire radio programs and will keep you thrilled all evening but I ain't heard one yet that a person wouldn't run a few wave lengths to miss the most of it and the majority of the performers seem to be cornet players and readers and speech makers that wouldn't dare to do their stuff if they was where you could get at them.

From the *Dundee (England) Courier*. (Exchange.)

## Calls Heard

(Continued from page 1649)

8BC, 8BDE, (8BDA), (8BEP), 8BFY, 8BHY, 8BOV, (8BERL), (8BYO), 8CC, 8CSD, (8EB), 8EH, (8EW), 8JQ, 8PU, (9AAW), (9ACB), (9ACM), 9ACN, 9ACW, 9AFK, 9AFW, 9AHG, 9AHQ, (9AHU), 9AHZ, 9AMK, (9AMQ), (9AMX), (9AOJ), 9ARX, (9ASO), 9AU, (9AVP), 9AWT, 9AYX, 9AYW, (9AZA), (9AZE), 9AZF, (9BCJ), 9BDR, 9BEF, 9BIZ, 9BLU, 9BME, 9BMN, (9BNU), (9BOF), (9BOO), 9BP, (9BQ), 9BQH, 9BXC, 9BWS, (9BYE), 9CEN (9CFI), (9CIC), (9CIV), 9CS, 9CTW, 9CZL, (9DAG), 9DCW), 9DEL, 9dGW, (9DHD), (9HZ), (9DIL), (9DPB), 9DQ, 9DRA, 9DSD, 9DTN, (9DUN), (9DVY), 9DVK, 9DWX, (9DX), 9DXT, 9DXV, 9DXH, 9DYZ, 9DZE, 9DZU, 9DZY, 9HT, (9JV), 9LF, 9MC, 9NO, 9OF, 9PD, 9PN, 9TV, 9VZ, 9XF, 9XV, (9ZC), 9ZN, 9ZU.

C.W.—4SK, 8ADG, 8AIM, 8BOG, 8IJ, 8UE, 8VQ, 8XH, 9ABV, 9AHH, 9AIP, 9AKV, 9ALR, (9AMQ), 9AUC, 9AWM, (9AZA), 9BAF, (9BCH), (9BHQ), 9BLF, 9BJI, 9BP, 9BSG, 9BTT, 9CGN, (9CJI), 9CMV, 9CVI, (9CZY), (9DCT), 9DQI, (9EAR), 9UU, (9XAC)foe, 9XM, (9ZL), 9ZN.

3BMN, PETERSBURG, VA. (ON ONE TUBE)  
All C. W.—1EO, 1FB, 1GL, 1GV, 1II, 1JT, 1IL, 1ON, 1SL, 1XP, AADL, 1AJF, 1ANR, 1ALZ, 1ASF, 1AYK, 1AZA, 1BES, 1BFE, 1BHR, 1BJN, 1BKQ, 1BRQ, 1BSZ, 1BWJ, 1CAJ, 1CAK, 1CDR, 1CHJ, 1CMK, 2BG, 2EL, 2FP, 2GI, 2LO, 2OM, 2UD, 2UE, 2VH, 2ZK, 2ZL, 2AJW, 2ANZ, 2AOS, 2ASW, 2AWL, 2AYV, 2BGI, 2BML, 2BRR, 2BXP, 2CBG, 2CBW, 2CBY, 2CEI, 2CFI, 2CJN, 2CJR, 2CMS, 2CMV, 2XAO, 2XAP, (3's too numerous), 4AS, 4BC, 4BO, 4BX, 4BY, 4DC, 4EA, 4EB, 4EH, 4EL, 4GH, 4HS, 4HZ, 4IZ, 4JK, 4KC, 4KK, 4KL, 4LJ, 4MT, 4NT, 4XD, 4YA, 4YL, 5DA, 5EK, 5KC, 5LT, 5MO, 5OM, 5XA, 5XK, 5ZB, 5ZS, 5ABY, 5ZAV, 8BK, 8FO, 8FT, 8FU, 8HK, 8IB, 8IJ, 8KG, 8OE, 8OW, 8PD, 8OK, 8SB, 8SP, 8TB, 8UE, 8UF, 8VY, 8XE, 8YN, 8ZP, 8ZW, 8ZY, 8ZZ, 9AAD, 9AAV, 9AAW, 9AEX, 9AFX, 9AHQ, 9AIX, 9AJH, 9ALR, 9AON, 9AOT, 9AOU, 9APS, 9AQM, 9ASE, 9AWF, 9AWM, 9AYH, 9AZE,

## Count the cost—

Two stages with  
2 popular \$5. transformers  
—Total amplification, 36.

Equipment cost:—		
2 transformers	@ \$5.00	\$10.00
2 tubes	@ 6.50	13.00
2 sockets	@ 1.00	2.00
2 rheostats	@ 1.50	3.00
	<b>Total</b>	<b>\$28.00</b>

One stage with  
1 AMERTRAN  
—Total amplification, 38.6

Equipment cost:—		
1 AMERTRAN		\$7.00
1 tube		6.50
1 socket		1.00
1 rheostat		1.50
	<b>Total</b>	<b>\$16.00</b>



Price \$7

Ask your Electrical Dealer, or sent carriage charges collect. (wt. 1 lb.)

## The AMERTRAN

moreover, secures its tremendous amplification absolutely without distortion on the part of the transformer.

It is doubtful if the substitution of any one thing in a radio set could make such a notable improvement as the installation of an AMERTRAN.

## American Transformer Company

Designers and builders of radio transformers for over 20 years.

177 Emmet Street, Newark, N. J.

## Radium Jewel DETECTOR

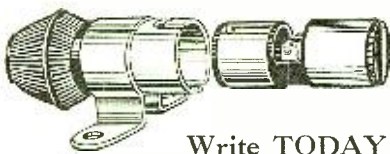

Write TODAY  
For Attractive Discounts

Far superior to the ordinary crystal detector. Extremely sensitive; easily adjusted; makes reception sharper and clearer; no battery or other accessories needed.

Combination, List.....	\$1.00
Detector Bulb .....	60c
Bulb Holder .....	40c

**STAR MANUFACTURING CO.** 868 Bergen Street  
NEWARK, N. J.

9AZI, 9BBF, 9BDB, 9BED, 9BES, 9BHI, 9BIE, 9BSG, 9BVZ, 9BWF, 9CBA, 9CIN, 9CPY, 9CUI, 9DBY, 9DCB, 9DQU, 9DWK, 9ECE.  
 Canadians: 2AZ, 2HG, 3CO, 3DH, 3JI, 9AL, (9BZ).

G. BONAVIA, 5DE, VICTORIA, B. C., CAN. (CRYSTAL TUNER)

6AA, AALU, 6AAR, 6ACR, 6ABR, 6AYM, 6ATV, 6ABW, 6AQU, 6AMW, 6AAU, 6ABU, 6ANG, 6AOA, 6AMK, 6ALV, 6ARK, 6ANK, 6ALA, 6AR, 6AG, 6AGK, 6AKT, 6ARX, 6AJE, 6ABV, 6AK, 6AQU, 6BUA, 6BIP, 6BBV, 6BAK, 6BFR, 6BH, 6DN, 6EK, 6EX, 6FC, 6HP, 6IC, 6IR, 6EM, 6LM, 6LU, 6OD, 6OS, 6OV, 6QK, 6Q3, 6OR, 6TU, 6WX, 6ZZ, 7AA, 7AIB, 7AAZ, 7ALA, 7AIO, 7BH, 7BK, 7GE, 7HD, 7IU, C.W.—7IZ, 7JK, 7ME, 7NE, 7OJ, 7TU, 7VE, 7VF, 7VG, 7WG, 7WQ, 7YG.  
 Canada: 3EC, 5CB, 5CN, 5DC, 5DX, 5ED, 5EG, 5EK, 5GO, 9AX, 9BD, 9BG.

8CBX, SPRINGFIELD, OHIO

AH C.W.—1AJU, 1ANY, 1AOL, 1AZW, 1BES, 1BEN, (1BSZ), 1CDO, 1CMK, 1CMP, 1FB, 1II, 1IL, 1KC, 1MY, 1RH, 2ANY, 2AOZ, 2AYV, 2CCD, 2CMS, 2GK, 2KP, 2SO, 3AAV, 3AD, 3AJB, 3ALE, 3AOR, 3BEL, 3BJ, 3BSB, 3BSS, 3BVL, 3CM, 3DE, 3FS, 3FU, 3GE, 3MO, (3SU), 3YW, 4CY, 4EL, 4KK, 4LJ, 4YA, 5AFO, 5DI, 5FK, 560, 5HF, 5JL, 5KG, 5KN, 5LB, 5NK, 5NS, 5NV, 5PF, 5PV, (5PX), 5QI, 5QY, 5RH, 5SF, 5TM, 5TP, 5UK, 5VO, 5VY, 5WV, 5XAB, 5XV, 5ZAK, 5ZAV, 6BUN, 6ZZ, 7SC, 7ZU, 7ZV, 8AAF, 8AB, (8ABV), (8ACK), 8AGP, 8AHR, (8AIM), 8AIO, 8ANN, 8APN, 8APW, 8ATV, 8AVD, 8AWP, 8AWT, 8AZD, 8AZF, (8BBC), 8BBI, 8BDN, (8BDO), 8BDV, (8BEK), (8BFB), (8BFD), 8BGL, 8BIK, 8BJC, 8BIL, 8BNK, 8BNZ, 8BOA, 8BOZ, 8BRC, 8RRM, 8BYF, (8BYN), 8BYO, 8CAB, (8CAU), 8CCB, (8CCS), (8CDZ), 8CGI, 8CGW, 8CIZ, 8CKN, (8COJ), 8COO, 8CP, 8CPD, 8CUF, 8CVE, (8CVG), (CWC), (CWP), 8CXW, 8CZZ, 8DAL, 8DAT, 8DY, 8FL, 8FU, 8KG, 8KR, (8LZ), (8OO), 8RJ, 8RR, 8TT, 8UB, 8UP, (8UR), (VO), (8WF), 8YN, 8ZB, 8ZL, 8ZW, 9ABV, 9AFN, 9AHH, 9AMH, 9AIP, 9AMO, 9ANO, 9AOG, 9AON, (9APM), 9AOT, (9AOZ), 9ARR, 9ASN, (9AUS), 9AVP, 9AWF, 9AWM, 9AYL, (9BBI), (9BDB), (9BDB), (9BED), 9BES, 9BFG, (9BGW), (9BKI), 9BNH, 9BRK, 9BSG, (9BSZ), 9BYX, 9BZI, 9CAC, 9CCM, (9CCS), 9CCV, 9CDR, 9CGK, 9CGU, 9CGY, 9CIA, 9CIC, 9CLW, 9CPW, (9CPY), 9CIR, 9CTF, 9CUC, 9CUI, 9CVO, (CXP), 9CXV, 9CWB, 9CZF, 9CZS, (DBL), 9DCB, (9DFR), 9DGE, 9DEF, 9DLR, 9DMJ, (9DTA), 9DVN, 9DYN, 9DZB, (9EBH), 9EBI, 9ECI, 9ECR, 9EFC, 9EP, 9GE, 9HK, 9LC, 9MC, 9MO, 9NK, 9PD, 9PS, 9PW, 9QF, 9RC, 9UC, 9UL, 9UU, 9VAJ, 9ZL, 9ZN; Canadians—3BV, 3CK, 3DH, 3JH, 3JI, (9AL).

LEONARD STROBEL, AKRON, OHIO. (DET. 2 STEPS)

SPARK.—2ABX, 2CN, 3CN, 4GN, 5XAC, 9AAW, 9AHY, 9ANP, AOT, 9AZE, 9BMN, 9BPJ, 9BXC, 9DHG, 9DNS, 9DRA, 9HE, 9JX, 9TV, 9ZH.  
 C.W.—I AKL, 1AR, 1AWB, 1BKO, 1BRO, 1BRY, 1BSD, 1CGR, 1CMD, 1CMK, 1COP, 1IL, 1KC, 1SN, 1TS, 1XP, 1XU, 1XZ, 1ZE, 2AGA, 2AIW, 2AOL, 2AWO, 2AYV, 2BER, 2BMR, 2BRB, 2BSC, 2BXW, 2CCD, 2CYO, 2CZZ, 2EL, 2FP, 2OE, 2OT, 2SU, 2ZS, 3AFB, 3AMR, 3AS, 3ATG, 3AWO, 3AYR, 3BI, 3BLE, 3BO, 3BOB, 3CAN, 3CC, 3CG, 3CY, 3DF, 3IW, 3JJ, 3LJ, 3LK, 3MB, 3OE, 3OI, 3OT, 3SU, 3XM, 3YO, 3ZZ, 4RX, 4CM, 4EA, 4EL, 4FT, 4BZ, 4KL, 4LP, 4XV, 5DK, 5EK, 5ES, 5FV, 5GD, 5GP, 5IG, 5IK, 5IR, 5KC, 5MA, 5MO, 5NT, 5PO, 5QM, 5OY, 5TA, 5XA, 5XAD, 5XB, 5XD, 5XK, 5ZA, 5ZAH, 5ZAZ, 5ZB, 5ZV, 6XAD, 6YW, Too many eights, 9AAF, 9AAP, 9AAR, 9AAU, 9AFI, 9AFN, 9AFS, 9AIP, 9AIV, 9AIX, 9AIY, 9AMH, 9AMQ, 9AMU, 9AOD, 9AOG, 9AOT, 9APM, 9APS, 9APW, 9AOH, 9ASK, 9AWM, 9AZA, 9AZI, 9BA, 9RAP, 9BDB, 9BDS, 9BED, 9BIK, 9BIO, 9BIT, 9BPI, 9BRK, 9BSG, 9BSQ, 9BTT, 9BXA, 9CBA, 9CCM, 9CEB, 9CED, 9CFY, 9CGK, 9CIT, 9CNS, 9CR, 9CUC, 9CXP, 9CZF, 9DGN, 9DGO, 9DGY, 9DHG, 9DKQ, 9DIR, 9DNH, 9DQE, 9DQN, 9DWK, 9DWM, 9DXM, 9DYG, 9EI, 9EP, 9FM, 9F, 9FW, 9GK, 9GX, 9HK, 9HV, 9IG, 9KM, 9LO, 9MC, 9OX, 9PI, 9PW, 9OR, 9RC, 9UC, 9WC, 9XL, 9XM, 9YAI, 9YB, 9YP, 9ZAA, 9ZG, 9ZL, 9ZN, 9ZT, 9ZV, Can.—9AL, C.W.  
 PHONES.—1BK, 1XAD, 2EL, 2XAP, 5ZAY, 5ZY, 6XB, 6XC, 9KP, 9XAC, 9XU, 9XV, 9YAD, 9YI, 9YY.

CALLS HEARD BY MR. THOMAS A. MARSHALL (6ZY) HONOLULU, HAWAII  
 1BCG, 1BDI, 2PW, 2GR, 2ZS, 2PO, 3BV, 3BLF, 3AAO, 3YO, 4ID, 4KK, 4BV, 5AK, 5SM, 5XK, 5UI, 5GI, 5TC, 5EK, 5CN, 5PX, 5ZA, 6XAD, 6CBI, 6BOO, 6BCR, 6CC, 6BRF, 6BVW, 6IF, 6BIO, 6XK, 6EN, 6KU, 6KA, 6BJO, 6BOF, 6BPI, 6ZZ, 6BQC, 6BJY, 6ZH, 6RM, 6ARB, 6ANH, 6AJR, 6AWT, 7BJ, 7ADP, 7AN, 7HD, 7NM, 7SC, 7FS, 8AB, 8BK, 8SP, 8BPL, 8VY, 8AZD, 8BKE, 8AOC, 8BEO, 8EY, 8FU, 8AQ, 8AIW, 8DAE, 8NA, 8AIM, 8BRM, 8CUR, 8ASV, 8ATU, 8AXC, 8AWP, 8BDW, 8CGP, 8CGX, 8CAA, 8FT, 8QK, 8UE, 8UZ, 8XE, 8ZY, 8NA, 9DQU, 9CMK, 9AOU, 9DSD, 9PS, 9KP,

# Things worth knowing about RADION

RADION is mechanically better than ordinary panel insulations, because, it will not warp in normal temperatures; it is easily worked with simple tools, cuts and drills clean without chipping.

RADION has a beautiful satin-like polish comparable to the finest finish ever put on hard woods.

RADION excels all other insulations in the four most important characteristics required for Radio use, viz: (1), low phase angle difference, (2), low dielectric constant, (3), high resistivity, and (4), non-absorbent qualities. Tests by U. S. Bureau of Standards, N. Y. Electrical Testing Laboratories and our own research laboratories establish these claims beyond question.

RADION costs no more, in most cases LESS than phenolic, laminated phenolic or other insulation materials usually offered for panels.

Genuine RADION is sold everywhere by dependable dealers. Genuine RADION is stamped RADION on each panel or dial or printed on the container in which it is packed.

RADION panels are made in 15 stock sizes, each packed in an envelope to protect the beautiful finish.

If you fail to get it tell us. We will see that you are supplied. Send 15 cents for sample test piece of RADION Panel.

American Hard Rubber Co.

11 Mercer Street

New York

Manufacturers and Moulders of

# RADION

"The Supreme Insulation"

# The Timmons Talker

Not Just Another Loud Speaker

but a self-contained, scientifically constructed instrument with remarkable reproductive power. It's just the attachment you need to enjoy radio the unselfish way and make your home the most popular in the neighborhood. THE TIMMONS TALKER needs no extra batteries and comes ready for instant hookup. It has wide amplification range and marvelous reproduction bringing out each shade of broadcasted tone.

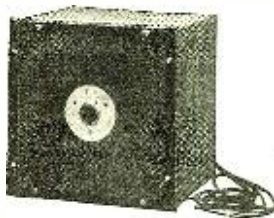

ITS STURDY CONSTRUCTION makes it almost unbreakable. Price, complete \$35.00.

If your dealer does not sell this unique instrument, write us for all the intimate details and give your dealer's name and address.



**J. S. TIMMONS,**  
Germantown, Philadelphia, Pa.

## Here's the Radiolean Jr.

Everybody wants this popular price Radio Set

Looks like a Detector Tube Set and can be changed into one at small cost. The Biggest Value ever offered by any Radio manufacturer.

This wonderful crystal receiving set is being sold for \$12.50 retail price which includes all equipment except phones. Head phones from \$3.00 upward. Get our prices on any radio goods you need and compare same with other dealers.



The "Radiolean Jr."

PRICE

**\$12.50**

without Headset

**\$15.00**

with Headset

### SPECIAL OFFER

- WESTERN ELECTRIC HEAD-SETS (Army type)..... **\$7.50**
- U. S. NAVY TUBES (Amplifying, Detector and Transmitting).... **\$4.25**
- PORCELAIN RHEOSTATS Each..... **35c**

Order the Radiolean Jr. at any Radio Dealer, Department Store, etc., or Direct from

## NATIONAL RADIO PRODUCTS CORP.

509 Fifth Avenue  
New York

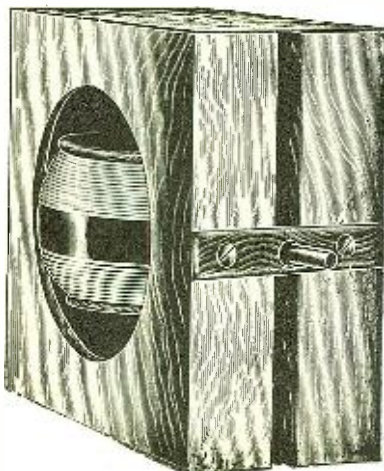

**\$2** MADE TO SELL FOR **\$5.00**

150-500 METERS  
1/4" SHAFT  
FAHENSTOCK CONNECTIONS

Send for Complete Catalogue

**DAVID KILLOCH CO.**  
57 Murray Street, New York  
WHOLESALE RETAIL

9BEY, 9APH, 9DOM, 9AVC, 9AW, 9BJU, 9BRI, 9BED, 9ABU, 9BIW, 9AFK, 9BLG, 9ANQ, 9BXO, 9BGH, 9BBF, 9BKH, 9BQW, 9BBS, 9BKP, 9BHI, 9BCH, 9CR, 9CCV, 9CDE, 9DSM, 9DXN, 9DOM, 9GK, 9LZ, 9XAC, 9ZN, 9YAJ, 9BJT

2BLQ AND 2BHF, NEWARK, N. J.

1DQ, 1II, 1ON, 1QP, 1AAP, 1AOK, 1AYZ, 1BAS, 1BES, 1BHR, 1BKQ, 1BOM, 1BXX, 1CAC, 1CDR, 1CMK, 1CPN, 3BQ, 3BZ, 3CG, 3CI, 3CQ, 3FU, 3HG, 3IW, 3JJ, 3JT, 3KL, 3LP, 3MO, 3NH, 3PZ, 3RF, 3SM, 3TJ, 3XM, 3AFB, 3AJJ, 3BGO, 3BHM, 3BIJ, 3BLF, 3BOB, 3BOF, 3BNU, 3BUV, 3BVA, 4EA, 4GL, 4NT, 5DA, 5FV, 5AK, 5AX, 5BK, 5BO, 5IJ, 5JU, 5SA, 5UE, 5XE, 5UF, 5VO, 5WR, 5ZD, 5ZW, 5ZY, 5ZZ, 5ABV, 5AGO, 5AIW, 5ALF, 5AMO, 5AMQ, 5AMB, 5AQO, 5AWF, 5AWR, 5AXC, 5AZF, 5BEA, 5BEF, 5BEN, 5BNJ, 5BNU, 5BNZ, 5BOO, 5BOZ, 5BQO, 5BRC, 5BRM, 5BSY, 5BRT, 5BVT, 5CAY, 5CMI, 5CMY, 5CTN, 5CWZ, 9II, 9IQ, 9LQ, 9UU, 9AAF, 9AIX, 9AWM, 9BDB, 9BQU, 9YAJ, CO, 3JT, 3AJ.

MR. GEORGE KLINE, ELIZABETH, N. J. (ONE TUBE)

C.W.—1AR, 1AW, 1CK, 1DQ, 1FB, 1FF, 1FM, 1FX, 1GV, 1HK, 1H, 1IL, 1IV, 1JT, 1KC, 1KX, 1LL, 1MY, 1OR, 1PR, 1RD, 1WN, 1XM, 1XP, 1AYO, 1AYZ, 1ADN, 1AWW, 1ALL, 1ALZ, 1AZW, 1AOK, 1AKB, 1ALR, 1ARY, 1ADL, 1AJT, 1BZD, 1BRQ, 1BWJ, 1BES, 1BQD, 1BOE, 1BHS, 1BOK, 1BJN, 1BKQ, 1BKA, 1BQL, 1BFE, 1BVB, 1BDB, 1BAS, 1BDI, 1BDT, 1CEK, 1CJO, 1CNF, 1CIC, 1CEC, 1CMP, 1CDR, 1CIV, 1IK, 3AV, 3BG, 3BX, 3CC, 3DH, 3FB, 3FO, 3FS, 3FU, 3HD, 3HG, 3HX, 3ID, 3IQ, 3JJ, 3IJ, 3MK, 3NH, 3OE, 3OT, 3OK, 3RD, 3SM, 3SU, 3TJ, 3VA, 3XM, 3YO, 3ZO, 3ZH, 3ZZ, 3ZW, 3APR, 3AQR, 3ARV, 3ABW, 3ALE, 3ADT, 3AOU, 3ADP, 3AFQ, 3AFC, 3AJJ, 3BGL, 3BLE, 3BWC, 3BFO, 3BOE, 3BFU, 3BIJ, 3BFA, 3BVC, 3BEC, 3BVL, 3BVC, 3BDT, 3CEL, 3CRO, 3CAQ, 4AT, 4BQ, 4BX, 4BY, 4CRR, 4CY, 4DL, 4EA, 4EB, 4EH, 4EL, 4ES, 4FG, 4FT, 4HT, 4JK, 4JZ, 4KC, 4KK, 4KL, 4KM, 4LJ, 4NT, 4OI, 4XA, 4YA, 5BA, 5BI, 5DA, 5EK, 5ES, 5EJ, 5HA, 5HL, 5IR, 5JL, 5KB, 5KC, 5TA, 5WU, 5XA, 5XK, 5ZA, 5ZB, 5OQ, 6RD, 6ZZ, 6XAD, 7ZO, 7ZU, 8AT, 8CN, 8CQ, 8CP, 8EG, 8EQ, 8FO, 8FT, 8GT, 8HH, 8IB, 8IJ, 8IU, 8KS, 8KU, 8LA, 8LT, 8ML, 8PD, 8OA, 8UE, 8UF, 8VK, 8VS, 8XE, 8YN, 8ZD, 8ZY, 8ZZ, 8AVD, 8ANJ, 8AZF, 8AOD, 8ALR, 8AXC, 8AER, 8ASV, 8AIM, 8AWJ, 8AIO, 8APO, 8ALZ, 8LTJ, 8AZO, 8ALT, 8ATH, 8ARV, 8AUM, 8AXN, 8AXB, 8AME, 8BKI, 8BHO, 8BJV, 8BXX, 8BEX, 8BNH, 8BOZ, 8BOA, 8BRM, 8BEO, 8BVR, 8BVD, 8BRC, 8BNU, 8BUN, 8BSY, 8BDA, 8BFR, 8BZO, 8BWK, 8BDB, 8BS, 8BFM, 8BDE, 8BEF, 8BLC, 8BXH, 8BAC, 8BUS, 8CVE, 8CGJ, 8COX, 8CGX, 8CYT, 8CTN, 8CHU, 8CRD, 8CVB, 8CPZ, 8CIH, 8ZC, 8CAB, 8CGP, 8CFP, 8CHV, 8CVA, 8CKO, 8CKM, 8CXK, 8DAK, 9AS, 9BJ, 9BS, 9BV, 9CR, 9DF, 9DP, 9EI, 9EP, 9FP, 9KP, 9LH, 9LQ, 9OX, 9PS, 9QF, 9VK, 9WZ, 9AAP, 9ANQ, 9AMI, 9AWM, 9ASE, 9AKU, 9AIX, 9AAU, 9ANS, 9APS, 9AMH, 9AMS, 9AFK, 9AMB, 9AUS, 9AON, 9BED, 9BXO, 9BIK, 9BZI, 9BTA, 9BDX, 9BDK, 9BBF, 9BAK, 9BKH, 9BQW, 9BYN, 9BEY, 9BDS, 9BVL, 9BKP, 9DB, 9BCH, 9BBI, 9BLY, 9BXL, 9CBA, 9CS, 9CVS, 9CYO, 9CEI, 9CTE, 9CGK, 9CIC, 9CYO, 9CTB, 9DLR, 9DNH, 9DIO, 9DYR, 9DKP, 9DFB, 9DTS, 9DJB, 9DYN, 9DBV, 9DVA, 9DMA, 9DWM, 9DLL, 9DDR, 9DDY, 9EIK, 9YAJ (special) AD-7. Can.—3GE, 3JI, 3SX, 9AL, 9AW, 9CD.

### GOOD WORK ON A CRYSTAL

Mr. Meyer M. S. Kraly of New York City reports the following stations with a loose-coupled galena crystal receiver:

Spark—1ATZ, 1AK, 1BOM, 1BOQ, 1BSB, 1BUB, 1BVD, 1CKI, 1CNI, 1RV, 1IU, 357 second district stations. 3AIC, 3AJD, 3ARM, 3ARO, 5GN, 3HJ, 3CN, 3RW, 3SF, 8ACO, 8BDA, 8BRL, 8BOV, 8CER, 8CYU, 8EST, 8EO, 8EV, 8FW, 8UC, 8VQ, 8TJ, 9AAV, 9ZN.  
I. C. W.—8XH 3AGT, 1XM.

### RADIOPHONE CALLS HEARD

Mr. Charles L. Cordon of Bridgeport, Conn., heard the following stations using but one tube:

WEAF, WJZ, WBZ, WSB, WNAC, WDAP, WDAF, WDAJ, WGI, WGY, WLW, WOC, WAAM, WHN, KYW, WWJ, WOR, WWZ, PWX, WHAS, WDM, NOF, WGR, WHAL, WMAK, WGF, KDKA, WBAP.

MR. EVERETT ADAMSON OF STERLING, COLORADO

WNAD, WOAL, KDYL, WBAP, WAN, WEAY, KLZ, KFAF, DDS, WOC, KUC, CJCG, WHB, WOS, WLW, KHJ, WPA, KFBK, KWH, WDAP, KZKN, WLAG, WLAJ, DN4, WCAS, WDAF, WFAA, WEAD, KGG, WEAT, KSD, WBL, FBB, WOK, WDT, WIA, WLK, WBAL, KDYS, WMAB, WAAZ, WHAS, WGAC, KYW, WEAF, KFA, KGY, KGW, KUY, KOG, CRCK, WEAH, WWAC, WDAO, WJAD, KFAD,





Want to Get  
More Distant Stations  
And Bring In All Signals  
Clear and Strong?



Then Install  
"All-American" Amplifying Transformers  
*(Radio and Audio Frequency)*

You'll be the envy of your radio-owning friends and neighbors because you'll get results that nobody can get without "All-American" Transformers.

R-10 Radio Frequency (150-550 meters)  
R-12 Audio Frequency (Ratio 3 to 1)

R-13 Audio Frequency (Ratio 10 to 1)  
R-21 Audio Frequency (Ratio 5 to 1)

Tell your dealer you must have "All-American" Transformers. Send for Bulletin No. 22—Free.



**RAULAND MFG. CO.**  
35 So. Dearborn St., Chicago, Ill.



**Kellogg Radio Equipment for Better Results**

W  
I  
T  
H  
  
K  
E  
L  
L  
O  
G  
G

U  
S  
E  
I  
S  
T  
H  
E  
T  
E  
S  
T

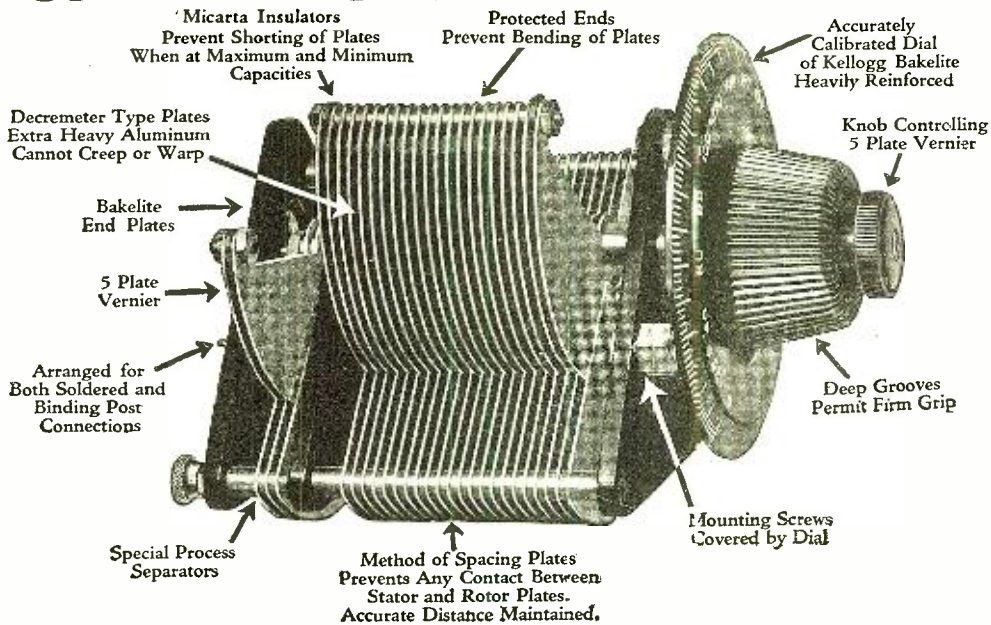

No. 601 11 plate with 5 plate Vernier. Knob and 4-inch Dial. Each .....\$6.75  
No. 602 11 plate without Vernier. Less Knob and Dial. Each .....\$4.50

No. 603 23 plate with 5 plate Vernier. Knob and 4-inch Dial. Each .....\$7.75  
No. 604 23 plate without Vernier. Less Knob and Dial. Each .....\$5.50

No. 605 43 plate with 5 plate Vernier. Knob and 4-inch Dial. Each .....\$8.75  
No. 606 43 plate without Vernier. Less Knob and Dial. Each .....\$6.50

Ask Your Dealer to Show You this Variable Condenser

**KELLOGG SWITCHBOARD & SUPPLY CO., CHICAGO**

What could be better  
Many New Improvements



More Volume

A Proven Successful  
Loud Speaker

TRUE TO ITS NAME

PATENT PENDING

A Perfect Radio Reproducer

The Trutone will operate on a crystal set with one or two stages of amplification.

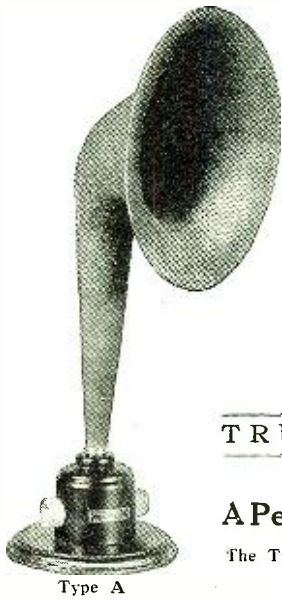

Type A

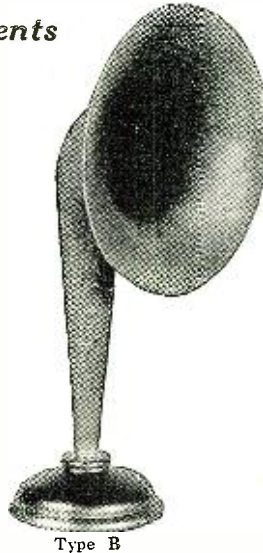

Type B

THE TRUTONE Amplifying Radio Horn is scientifically designed in accordance with Acoustic laws, constructed of Non-Metallic Seamless Composition with an approved wooden tone chamber in base, which brings out clear resonate trutone values with the maximum of volume. The base of type A-1 is designed for ready reception of both Receivers without removal of Head Band. Phones resting against Soft Rubber Bars, thus blending strength of both into one. Horn and base finished in Black Crystalline Baked Enamel, Nickel Trimmings; 12-inch Bell, stands 24 inches high. Packed in individual cartons.

PRICE  
**\$8.00**

EITHER TYPE  
Postage Postpaid  
Dealers: Write  
for discounts.  
No batteries used

THE TRUTONE Amplifying Radio Horn, scientifically constructed of Seamless Non-Metallic Composition, is free from the objectionable Metallic Ring common to most Loud Speakers. It is light, durable and ornamental. The base of Type B-2 is designed for ready reception of any single Receiver, "Baldwin" or others. Horn and base finished in Black Crystalline Baked Enamel, Nickel Trimmings; 12-inch Bell, stands 22 inches high. Packed in individual cartons. Horn fits either type base. Price with both bases \$10.00.

Horn Without Base \$6.00. Ferrule for Adapting Horn to Magnavox 25c

Manufactured By— **SADLER MANUFACTURING CO.**

86 FOURTH STREET Phone Garfield 1076 SAN FRANCISCO, CALIF.

KFAU, WHAF, WGF, CHCB, KDKA, WEAL, WKY, WGM, KFAG, WAAW, WDAH, WIAK, KNJ, WJD, KOA, 3XW, WLAA, WFI, WEV, WSB, CHBC, WJAP, WNAL, KNJ, WNAT, WKAK, WDAY, WOI, KDZG.

THE FOLLOWING STATIONS WERE HEARD BY MR. E. L. KARNS, OF TOLEDO, OHIO, USING A THREE-CIRCUIT TUNER AND A THREE-STAGE AUDIO FREQUENCY AMPLIFIER:—

WWI, WCX, WWJ, KDPH, WJK, WHU, WBAJ, KDKA, WKY, WJS, WBS, WGY, WHK, WIAX, 8YD, SVT, 3XW, WLK, WOH, WHA, WSB, WGM, NOF, WIK, KSD, KDAF, WHAS, WKN, WBB, WOC, WAAJ, WFAA, 2XB, WEAF, WJX, WOI, WOR, WAAP, WLW, WHAS, WOX, WDAW, WAAC, WCAX, WBAP, WIAX, PWX, WDAJ, WAAK, WNAC, WOS, WEAO, WMAK, WLAG, WMAO, WALO, WBT, WGF, KHJ, WFAC, CJCG, 2XAI, IXAE, KFAP, WGR, WIAO, WOAC, WGL, WSY.

BROADCASTING STATIONS HEARD BY JOHN MARSH, EUREKA, CALIF.

KFU—Gridley, Calif.	165 Miles
KVO—Sacramento, Calif.	200 "
KDN—San Francisco, Calif.	240 "
KLX—Oakland, Calif.	240 "
KCO—San Francisco, Calif.	240 "
KSL—San Francisco, Calif.	240 "
KPO—San Francisco, Calif.	240 "
KRE—Berkeley, Calif.	240 "
KZM—Oakland, Calif.	240 "
KLP—Los Altos, Calif.	250 "
KVVG—Stockton, Calif.	250 "
KFAS—Reno, Nevada	250 "
KOW—San Jose, Calif.	275 "
KVG—Portland, Ore.	350 "
KGG—Portland, Ore.	350 "
KNG—Portland, Ore.	350 "
KGW—Portland, Ore.	350 "
KNT—Aberdeen, Wash.	450 "
KFT—Los Angeles, Calif.	580 "
KHJ—Los Angeles, Calif.	580 "
KOG—Los Angeles, Calif.	580 "
KWH—Los Angeles, Calif.	580 "
KYG—Los Angeles, Calif.	580 "
KFC—Seattle, Wash.	600 "
KJR—Seattle, Wash.	600 "
KUY—El Monte, Calif.	600 "
KDYL—Salt Lake City, Utah	650 "
KZN—Salt Lake City, Utah	650 "
CHBC—Calgary, Alberta, Canada	775 "
KDYS—Great Falls, Montana	850 "

Some Experiments with  
Condenser Aerials

(Continued from page 1650)

Mr. R. Berndt of 4528 Richardson Ave., Bronx, N. Y., has a more revolutionary type of condenser aerial, claimed to have an overall efficiency of 50 per cent greater than the usual type. Fig. 3 illustrates this aerial.

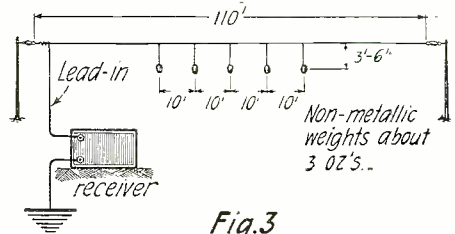

Fig. 3  
A Unique Type of Aerial Having Vertical Wires Suspended from the Main Aerial. These Are Held Taut by Small Weights.

The vertical portions furnish the added capacity. Mr. Berndt also uses a crystal receiver.

We know of a number of instances where copper screening, copper sheeting and standard condenser were used in place of the usual aerial, with exceptional results.

We feel that there is room for much experiment on this type of aerial, and hope that this article may inspire enough interest to perpetuate development.

NEW TRANSMITTER INSTALLED  
AT WJZ

Radio listeners were recently startled by the great improvement in the power, clearness, and brilliancy of the voice of WJZ, the Radio Corporation-Westinghouse radio station at Newark, N. J.

The explanation of this improvement is

Don't Be Careless—Protect Your Radio Set  
With the Dependable

**BRACH**  
VACUUM  
RADIO PROTECTOR

It Lasts For Years

Acknowledged by the most experienced engineers to be the best of all instruments for reducing static interference. Positively protects apparatus against lightning. In use for over 17 years.

Approved by the National Board of Underwriters



At All Dealers or by Mail at 25c a Tube.

Mend Your Wires  
and Joints With

**SOLDERALL** A Metal  
In Paste Form

Insures perfect reception. All you need is a tube of this paste solder and a match to heat it. Results guaranteed equal to bar or wire solder.

L. S. BRACH MFG. CO., Newark, New Jersey

COAST REPRESENTATIVES—Pacific States Electric Co., San Francisco, Los Angeles, Oakland, Seattle, Portland, Spokane

Surprise Offer

**\$1.48**

Vermiea Variable Condenser  
Capacity .0005 MF  
Large production permits  
this price

Newest Style Condenser. Sharp  
Tuning—Close Adjustment.  
Endorsed by leading Radio  
authorities.

If your dealer can't supply  
WRITE TODAY. Send check, Money Order.

Satisfaction Guaranteed or Money Refunded.  
C. S. CHERPECK CO., 3127 Davlin Court, Chicago

RADIO SERVICE PRODUCTS

- Tubular Grid Leaks (.2, .5, 1.0, 1.5, 2.0, 3.0 megohms) .....\$0.50 each
- Tubular Grid Leaks mountings..... .35 each
- Single V. T. Sockets Type S-10..... .90
- Triple V. T. Sockets Type S-4..... 2.70

RADIO SERVICE & MFG. CO. (Est. 1918)

Sales Div. 507-5th Ave., N. Y. C.

Factory—Lynbrook, L. I.

We carry a Complete Line of Radio Apparatus



# Federal



## RADIO APPARATUS



Variocoupler



Audio Frequency Transformer



Rheostat



Variable Condenser

*Will Give Greatest Satisfaction*

**Universally Accepted as The Standard**



Head Telephones

SCIENTIFICALLY DESIGNED  
MECHANICALLY CONSTRUCTED  
HIGHEST GRADE MATERIALS

RIGIDLY INSPECTED  
THOROUGHLY TESTED  
FULLY GUARANTEED



Radio Frequency Transformer



Potentiometer



V. T. Socket

We Manufacture a COMPLETE LINE including  
Knobs and Dials, Rheostats, Potentiometers,  
V. T. Sockets.  
HEAD TELEPHONES  
Condensers, Grid Leak, Plugs, Jacks, Anti-Capacity  
Switches, Transformers, Microphones, Radio and  
Audio Frequency Amplifiers, Complete Receiving  
Units, Etc.

*Write For Descriptive Literature and Prices*

### Federal Telephone & Telegraph Co.

Buffalo, N. Y.

DX DX DX DX DX DX DX DX DX DX

## DX Radio Frequency Transformer

### *THE FIRST and the BEST*

The DX Radio Frequency Transformer was the first on the market and is covered by United States Patents 1,439,562 and 1,439,563 granted December 19, 1922, and applications now pending which cover broadly among other things the feature of plugging in a transformer between the input and output circuits of electron tubes in an amplifier. Dealers should take the precaution that slip-in radio frequency transformers of either the socket type or panel type, and radio frequency transformers of a construction designed after the DX Transformer are obtained from authorized licensees under the patents of the Radio Instrument Company, Inc. Patents Pending in principal foreign countries.

*It PAYS TO HAVE THE BEST*



RADIO INSTRUMENT COMPANY, INC.  
WASHINGTON, D. C.

**THE PIONEER IN RADIO FREQUENCY**

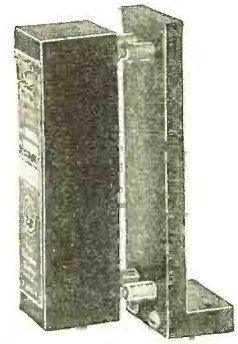

Patented Dec. 19, 1922

BUY IT  
and TRY IT

	Wave-Length	
Dealers Write for Literature	Range	Price
	DX-1 . . . . 170- 450	\$8.00
	DX-S . . . . 400-1200	8.00
	DX-2 . . . . 900-3000	8.00

DX DX DX DX DX DX DX DX DX DX

# Make Your Crystal Set 100% Efficient

BY USING

The **WORLD'S GREATEST RADIO CRYSTAL**

## MPM

"MILLION POINT MINERAL"

THE discovery of M. P. M. has revolutionized the possibilities of ordinary crystal sets. Concerts have been clearly heard over 600 miles. M. P. M. is super-sensitive—reproducing from every point on its surface. It increases audibility as well as radius, and makes the purchase of an expensive tube set unnecessary.

Send 25c and name of your Radio Dealer for a sample M. P. M. crystal—concert tested and guaranteed.

DEALERS: Write today for our attractive sales proposition.

**M. P. M. SALES COMPANY**

247 S. Central Ave.

Dept. N.

Los Angeles, Calif.

### IF WE COULD ONLY PRINT THESE PICTURES IN THE NATURAL COLOR OF THE "PIONEER" INSTRUMENTS!

The result would be *magical*. For, in all Radiodom there are no accessories as richly beautiful as the

"Pioneer" Moulded Bakelite Variometers and Variocouplers

Shells are highly burnished Bakelite, finished in elegant brown circassian walnut pattern. Roto-spheres are wound with rich, dark-green, silk-covered wire. Hardware is nicked and burnished.

Best of all, this outward beauty is a true index of the *Radio-Engineering* perfection of these instruments. Their *performance* is even more "beautiful" than their appearance.

Note how the Pioneer *Variocoupler* is *inside-wound* like a variometer. This adds greatly to its effectiveness.

*Jobbers and Retailers* will find it to their advantage to send for samples and get our proposition.

**PIONEER RADIOPHONE CORPORATION**  
GALESBURG, ILL., U. S. A.

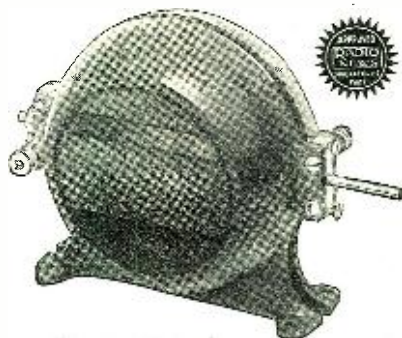

Pioneer Variometer .....\$6.50

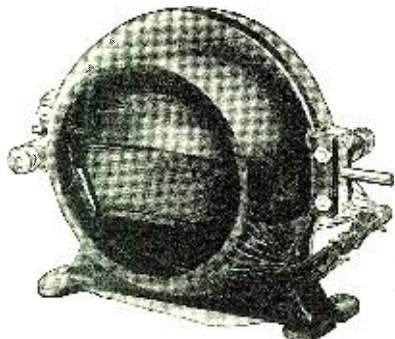

Pioneer Variocoupler .....\$7.00

that WJZ has a new transmitter. Though the old one was generally regarded as one of the finest in the country, recent developments by the Westinghouse engineers rendered it obsolete, so that it has been removed and a new one, up-to-date in every respect, has been installed in its place.

This new transmitter is rated at double the power of its predecessor, or 1,000 watts, and is greatly superior in the details of its transmitting, modulating, and generating system. Hence it is about three times more effective than the old transmitter. While listeners with electron-tube receivers all over the country have been quick to notice the change, it has been especially pleasing to local owners of either crystal detectors or loud speakers, who are now able to get unprecedented results from their instruments.

WJZ now ranks first among the broadcasting stations; but other improvements now being perfected by Westinghouse engineers are in store for it, so that it is not yet at the end of its development.

"The new transmitter consists of four oscillators modulated by five modulator tubes of special design. A new amplifier which steps up the energy received from the studio has also been installed."

### Points on Loud Speaker Operation

(Continued from page 1651)

nals may not be satisfactory if the operator abuses his tubes and the operation of his set. If you are located very close to a broadcasting station you will of course not be troubled with weak signals, and there will not be the temptation to get as near the oscillation point—which means distortion—as there would be with weaker signals. In general, if you obtain good, clear music or voice in your detector tube circuit with a headset, you will obtain the same clear signals in your two stage output to your loud speaker.

The demand for horns to be attached to some form of telephones has been such as to bring forth on the market some fine equipment. A glance through the advertising columns of RADIO NEWS and other radio magazines will call to your attention several types of horns made either of metal or of composition and designed to reproduce the tones perfectly. There is of course the old style of phonograph horn which is now obsolete due to the introduction of the cabinet type of talking machines. These horns are rather hard to obtain due to the former demands of the radio enthusiast of the last year or two, and although they reproduce satisfactorily, they are at best awkward additions to a set.

### U. S. A. SIGNAL CORPS RADIO APPARATUS RELEASED

194-W Western Electric Aviation Type Phones, complete with Sponge Rubber Ear Cushions, Headband and Aviator's Helmet; 2200 ohms; 22000 ohms impedance..... **\$795**

Signal Corps Super-Sensitive Microphone Transmitter. Operates with Local Battery from 4 to 22 Volts. **\$245**

Large Soft Sponge Rubber Ear Cushions. When applied will make any Headphone sound-proof and more comfortable; aviation type.... **50c Pr.**

**Izenstark Radio Co.**  
509 S. State Street CHICAGO, ILL.

### RADIO SUPPLIES AT CUT PRICES

Murdock Headsets—2000 ohm No. 56.....	\$4.49
Murdock Headsets—3000 ohm No. 56.....	4.98
Federal Headsets—2200 ohm.....	6.25
Western Electric Headsets.....	10.49
Thornderson Amplifying Transformers.....	3.49
Jefferson Amplifying Transformers No. 41.....	3.49
Ame Amplifying Transformers.....	3.98
Eveready Variable B Battery No. 766.....	2.00
Eveready Variable B Battery No. 763.....	1.25
Eveready Variable B Battery No. 767.....	4.00
Cyclone Variable B Battery—22½ volt.....	.90
Cyclone Variable B Battery—45 volt.....	2.50
De Forest Crystal Sets Complete with Federal Phones.....	18.50
Firco (Bull Dog Grip) Phone Plug.....	.98
Fada Type Rheostats.....	.45
De Forest Type Sockets.....	.45
43-Plate Variable Condensers.....	2.00
23-Plate Variable Condensers.....	1.50
3½-inch Dials.....	.35
4-inch Electrode Dials.....	.98
7-strands Copper Aerial Wire.....	.60
No. 14 Solid Copper Aerial Wire.....	.40

**KENSINGTON RADIO SUPPLY CO.**  
4417-18th Ave. BROOKLYN, N. Y.

### Single Circuit Receivers

(Continued from page 1630)

In the first place, it should be clearly determined which instruments, which knobs or dials, are concerned with tuning, which with regeneration. The inter-relation of the various parts of the circuit is such that the adjustment of the "tickler" will affect the tuning indirectly, but do not make a wavelength readjustment in this way. For the almost inevitable result is distortion or a weakened signal. A slight turn of the rheostat knob controlling the brightness of the detector tube's filament will not ma-

RADIO RANGER MODEL RECEIVING SET

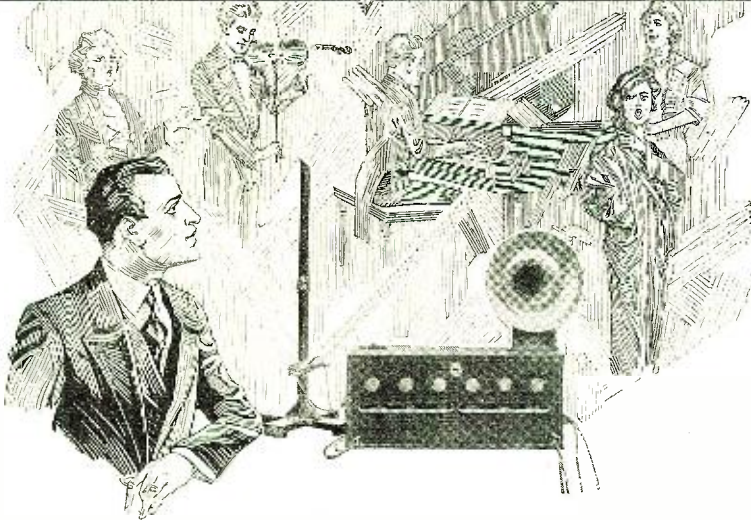

## A Front Orchestra Seat in Your Own Home

To sit in front of this box, connected to an indoor loop, a battery and a loud speaker, is often expressed by radio "bugs" as like having a seat in row A at a good show. Loud, clear music or singing transmitted to your home from all parts of the nation. And the complete set can be placed on the ordinary size table. Even your walls can't keep the concerts from reaching the small loop pictured. The concerts come in as "clear as a bell," making one think that the talent of the U. S. is in your own home performing for you. You, your family and friends can enjoy a real entertainment any night in the week.

The list below of stations was heard by the Radio Ranger Model J. R. H. Receiving Set during October from Buffalo, N. Y. As many as fifteen different stations were heard in one evening.

Anacostia	NOF	Detroit	WWJ	Kansas City, Mo.	WHB	Cleveland	WHK
Atlanta, Ga.	WSB	"	WCX	"	WDAF	Brownsville, Pa.	WDAQ
"	WGM	Boston, Mass.	WAAJ	St. Louis	KSD	Philadelphia	WIP
Chicago, Ill.	WDAP	"	WNAC	Newark, N. J.	WOR	"	WOO
"	KYW	Holyoke	WHAX	"	WJZ	Dallas, Tex.	WFAA
"	WMAQ	Medford-Hillside	WGI	Buffalo, N. Y.	WGR	Ft. Worth	WPA
Indianapolis, Ind.	WGU	South Dartmouth	WMAF	Lockport	WMAK	"	WBAP
"	WLK	Springfield	WBZ	New York City	WEAF	Waco	WLAJ
Ames, Ia.	WOH	Worcester	WCN	"	WBAY	"	WJAD
Davenport	WOI	Minneapolis, Minn.	WCE	Rochester	2XB	Calgary, Can.	CFAC
Des Moines	WOC	"	WAAL	Schenectady	WHAM	Toronto	CFCA
Louisville, Ky.	WGF	"	WBAD	Troy	WGY	Vancouver, B. C.	CJCE
Dearborn, Mich.	WHAS	"	WBAA	Cincinnati, O.	WHAZ	Winnipeg	CJCG
	WWI		WLB		WLW		

Fedders Mfg. Co., Inc., 55 Tonawanda St., Buffalo, N. Y.

# The RADIOGEM

(Patents Pending)

**\$1** Receiving Set—The Simplest Radio Outfit **\$1**  
 Made—Yet as Practical as the Most Expensive!

You need know absolutely nothing about wireless to operate and enjoy the RADIOGEM. It is so sturdy, so simply constructed that it is small wonder radio engineers who have tested it have pronounced the RADIOGEM a brilliant achievement. The RADIOGEM is a crystal radio receiving set for everyone at a price anyone can afford.

**Why The RADIOGEM Can Be Sold For Only \$1**  
 Here's the secret: The RADIOGEM Construction eliminates all unnecessary trimmings, cabinets and the like, which do not play any part in the operation of a set. You receive the RADIOGEM unassembled, together with a clearly written instruction book, which shows you how to quickly and easily construct the set, using only your hands and a scissor. The outfit comprises all the necessary wire, contact points, detector mineral, tube on which to wind the coil, etc., etc. The instruction book explains simply and completely the principles of radio and its graphic illustrations make the assembling of the RADIOGEM real fun. Remember the RADIOGEM is a proven, practical radio receiving set and will do anything the most expensive crystal set will do.

**The RADIOGEM is the Prize Winner of the Age**  
 Out of hundreds of radio models submitted recently in a great nation-wide contest, radio engineers, the judges, unanimously chose the RADIOGEM as the winner—the simplest radio-receiving set made! And the RADIOGEM costs you nothing to operate; no form of local electricity is required.

**DEALERS** The RADIOGEM is the wonder item of the radio age. It is storming the country, for the RADIOGEM'S price is so low everyone is able to buy one. Write immediately for full particulars before that shop across the street beats you to it.

Hear the programs of the Broadcasting Stations on the RADIOGEM



**\$1**

Without Phone or Aerial

Receives up to 20 Miles



**RADIO "A" & "B" STORAGE BATTERIES CHARGED, AT HOME, FOR FEW CENTS, WITH "PATENTED FULL WAVE" 100-130 Volt 60 Cycle A. C. AUTOMATIC MAGNETIC F-F RADIO RECTIFIER**

Eventually You Will Buy An F-F RECTIFIER. Why Not Now? The Sooner You Buy It, The More You Save.

It CHARGES All 6 Volt RADIO "A" & AUTO Batteries; & All RADIO "B" & LOUDSPEAKER Storage Batteries Up To 120 Volts In Series Inductively At Home Overnight. Disconnecting & Multiple Connections Unnecessary. Charging Circuits Separate. Nothing Like It Made. No Chance For Grounds Or Short Circuits. No Skill Required. AMMETER Eliminates Guess Work. It Costs You Less To Buy An F-F RECTIFIER than To Be Without One. You PAY for ONE Whether You Buy One Or Not, for It Costs An Average Of \$2. for Charging & Rentals Every Time An Auto Battery Is Charged By Others, but Only A Few Cents When You Charge Your Own From A Lamp Socket With An F-F Battery Boosting RECTIFIER. If You Have Never Known The Delightful Feeling Of Having Your Storage Batteries Always Fully Charged for RADIO & AUTO You Will Experience A New Thrill When You Have An F. F. RECTIFIER Which Gives You A Fully Charged Battery Overnight At A Cost of A Few Cents & A Pleasant Feeling Of Things Well Done. Those Who Own Them Feel Their F-F RECTIFIER is Their Faithful Friend. It Charges Automatically & Being Clean Can Be Placed Anywhere. Nothing To Slop Over Be Filled Burn Out Need Attention Or Cause Trouble. Both Waves Are Rectified Thru Infusible Carbon Rectifying Brushes, Maintaining Constant Efficiency Uninterruptedly. While Its FULL WAVE Delivers RAPID TAPER CHARGE recommended By All Storage Battery Manufacturers. The F-F RECTIFIER is A Complete Compact Portably Handy Charging Unit. Delivers Service Day & Night Automatically & Will Charge Dead Battery. Do Not Think Battery is Dead & Worn Out Simply Because It Will Not Start Your Car. Buy An F-F RADIO RECTIFIER & Fill It With LIFE. It SAVES MORE than Its Cost & Lasts Lifetime. Leave Your Battery In Car, Or Where Ever It Is, Without Even Disconnecting It. Screw RECTIFIER Plug In Lamp Socket, Snap RECTIFIER Clips On Jattery Terminals; Turn Switch & Battery Will Be Charged In Morning At Cost Of Few Cents. Is It Not Gratifying To Be Ready For All RADIO PHONE BROADCAST Music Sermons & News When Friends Call? Never Having To Be Careful Of, or Tell Friends Your Batteries Are Dead & To Feel Your Car Respond Like A Greyhound, Spinning Engine With Power When You Throw In STARTER? Fully Charged Battery Starts Car Quick & Requires Fewer Expensive Replacements. INSIST on The F-F RECTIFIER. Built By A Master Of The Art in 7 Types. So Many Thousands Are Being Sold It Has Made Possible These POPULAR PRICES

**\$20**

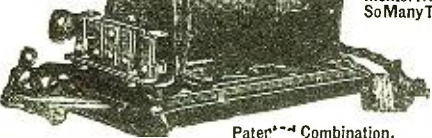

Patent Combination.

CHARGES "A" & "B" RADIO & AUTO BATTERIES. The Lower 3 are Large TYPES Built For Heavy Batteries, or Where Time Is Limited. SHIPPING WEIGHTS Complete With AMMETER & BATTERY CLIPS 11 to 15 Lbs. Purchase From Your Dealer Or Mail Check for Prompt Express Shipment. If Via PARCEL POST have Remittance Include Postage & Insurance Charges, or WRITE Us To Ship TYPE Desired C. O. D. Other F-F Battery Boosters Charge Batteries From Farm Lighting Plants & D. C. Circuits & for GROUP CHARGING Economy Use Our 8 Ampere 12 Battery Capacity Automatic Full Wave F-F ROTARY RECTIFIER described in ROTARY BULLETIN 32A. ORDER Now, or WRITE Immediately for FREE Descriptive RADIO & AUTO BOOSTER & ROTARY BULLETIN 32A & 32 General OFFICES & WORKS: CLEVELAND, OHIO, U. S. A. Canadian Distributor: The Jack V. Elliot Co., Hamilton, Ontario, Canada.

**FRANCE MFG. CO.**

terially affect the tune but it will afford a very convenient means of making a delicate adjustment of the regeneration. "Regeneration," by the way, is a form of high or "radio" frequency amplification which can be made to occur simultaneously with detection in the first or "detector" tube. It is very desirable if, as it were, it is "handled with gloves." Uncontrolled, it is the most disturbing factor in reception: witness the shrieks or whistles from radiating receivers in any city. If you insist upon tuning in a station by the heterodyne of its carrier wave, the following procedure is suggested:

Turn the tuning dial or switch to the approximate position for the reception of the station in question. Then, with the detector at its normal brilliancy, turn the dial of the tickler or plate circuit variometer in the direction of increase to a value just sufficient to "bring in" the whistle of the carrier wave when the tuning dial is turned to the right or left. Upon the tuning dial two points will be found, very close together, at which the whistle of the carrier wave of a particular station can be heard. Exactly midway between these two points is the correct wave-length adjustment: note it carefully. Then slightly decrease the filament current until a point is reached at which a slight turn to the right or left of the tuning dial (or its vernier) does not give the sound of the carrier wave. Make sure that the tuning dial is returned to the predetermined position. Now your receiver is adjusted to yield maximum signals without excessive distortion. Sometimes, however, it is desirable to turn the filament still lower, to secure even greater clearness. Remember that if your receiver is in a state of oscillation, the condition at which the carrier wave can be heard, the result is not only distortion of the received matter but also a radiation which interferes with the other listeners of your vicinity.

Of all the criticisms directed against the single circuit the most ubiquitous is that "it tunes broadly," though quantitative evidence is conspicuously absent, in each case. Certain it is that a great relative improvement in the sharpness of tuning is obtained by the use of lower capacity and higher inductance in the antenna circuit. Specifically, if your receiver is one of the many on the market which have a tapped inductance and a variable condenser, you should turn the inductance switch as high and the condenser as low as possible in securing the tune for any given wave-length. A capacity of less than .0001 mfd. has been used with good results, in the antenna circuit. In any case the capacity in the antenna circuit can be decreased by connecting a condenser of low capacity, preferably variable, between the antenna and the antenna binding post of the receiver. The use of low capacity and high inductance "stiffens" the antenna circuit remarkably; the resultant selectivity is incomparably improved. It may be mentioned that an extremely long antenna itself tends to broaden the tuning. Low resistance makes for a selective circuit: the importance of good ground and other connections cannot be over-estimated.

Used intelligently, the single-circuit has distinctive merits; used otherwise, it impresses us chiefly with its faults. But let us not confuse the issue.

—Contributed by F. Williams.

# SAVES YOUR BATTERY



**SCIENTIFICALLY ACCURATE**

**NO TAPPING**  
**NO ROLL**  
**NO COAXING**  
**NO DROP**  
**NO DRAG**

**HEAVY GLASS DOUBLE LIFE**

**PRICE \$1.25**  
**U.S.A.**

**FLOAT GUARANTEED NOT TO STICK**

Your storage battery is the life of your Radio Set. And every time you use it there is a loss of power. The lower the charge, the faster it goes. To run the charge low damages the battery itself.

### READ-EASY HYDROMETER

doubles and trebles the life of your battery by keeping a constant check on its condition. It gives

### ABSOLUTELY ACCURATE READINGS

Inspect your batteries once a week with the Read-Easy Hydrometer. Absolutely guaranteed.

Anyone can read it.

Non drop      Never sticks  
Non slop      Absolutely Accurate

Every dealer can furnish you with the READ-EASY, if he will.

Be sure to get the Read-Easy.. Do not accept cheap, inaccurate instruments. At your dealer's or direct, if he will not supply you, at \$1.25 post-paid and insured.

Radio Division 12  
**ALA MFG. CO.** 401-417 S. Sangamon St.  
CHICAGO, ILL.



## World Radio Batteries

### SAVE YOU 50%

WRITTEN 2-YR. GUARANTEE

Direct factory to user sales methods save you 50%. Highest quality material insures you 100% service. Every battery backed by our written two-year guarantee. You take no risk. Batteries shipped express C. O. D. for your inspection. Mail your order today—at once.

#### COMPARE THESE PRICES

6 Volt. 40 Amps.	\$ 8.50
6 Volt. 80 Amps.	10.00
6 Volt. 80 Amps.	12.50
6 Volt. 100 Amps.	14.50

No other manufacturer offers such a high quality battery at such a low price. Save 50 per cent on your next battery and get better and longer service—buy a World Storage Radio Battery. Write today.

World Battery Co., 1219 S. Wabash Ave., Dept. 1, Chicago

### Pay No Express or Postal Charges

## March Radio Slaughter

Sent Postpaid anywhere upon receipt of Money Order cash or check

\$6.50 Guaranteed (dry cell) 1 1/2 Volt Tubes (Detector or amplifier) fits standard socket	\$4.95
\$5.00 Detector Tubes guaranteed	\$3.00
6.50 Amplifier Tubes guaranteed	3.50
4.75 —43 Plate Variable condensers	2.85
3.75 —23 Plate Variable condensers	1.85
0.00 Federal Everett or Dreyfuss Head Phones	6.00
2.00 Vario couplers	2.50
2.00 Variometers	2.75
1.00 V. T. Sockets	.50
1.00 —3 inch Hard Rubber Dial (3 for 1.15)	.45
4.50 Thordarson Transformers	3.65
6 Volt Guaranteed U. S. Storage Batteries shipped via express prepaid	7.50

PRICE LIST (100 other Bargains) FREE Previous customers send for Price List of 200 new Electrical Bargains.

**Broadway Electrical Novelty House**  
134 Third Avenue, New York, N. Y.

### RADIO ENTERTAINMENT FOR HIRE

A new phase of the radio game is that of "entertainment" service furnished on call, just like an orchestra service. If you want radio entertainment, a Washington radio concern states it will bring a set, install it and guarantee entertainment from the ether suitable for a social evening, "or no charge."

# Armstrong Super Heterodyne Receiver

*"The Rolls Royce Method of Reception"—E. H. Armstrong.*

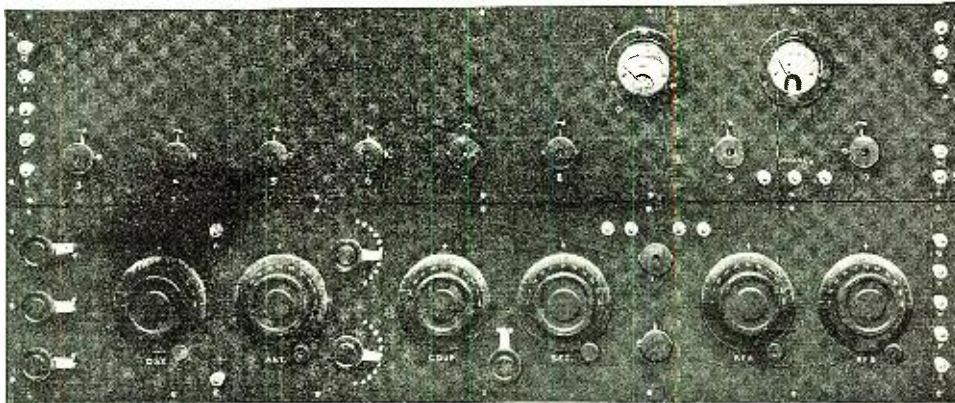

*Obtainable Exclusively Through*

## EXPERIMENTERS INFORMATION SERVICE

*Designers of the Highest Class  
Radio Apparatus in the World*

220 West 42 St., 23rd Floor

New York City

*Ask for 1923 Catalog No. 20*

## RADIO MERCHANDISE

**F. D. PITTS COMPANY**

(Incorporated.)

219 COLUMBUS AVE., BOSTON, MASS., U. S. A.

*Wholesale Only*

**Distributors for**

A. H. Grebe and Co.  
Acme Apparatus Co.  
American Eveready Works  
American Radio and Research Corp.  
Atwater Kent Mfg. Co.  
Baldwin, Nathaniel Co.  
Burgess Battery Co.  
Chelsea Radio Co.  
Clapp-Eastham Co.  
De Forest Tel. and Tel. Co.  
Dubilier Condenser Co.  
Electrose Mfg. Co.  
Fada.  
Fahnestock Elec. Co.  
Federal Tel. and Tel. Co.  
France Mfg. Co.  
Frost, Herbert H. and Co.  
General Radio Co.  
Jewell Elec. Inst. Co.  
Magnavox Co.  
Mitchell, R. and Co.  
Murad Laboratories  
Murdock, Wm. J. Co.  
Pacent Elec. Co.  
Radio Corp. of America  
Remler Radio Mfg. Co.  
Signal Elec. Mfg. Co.  
Western Elec. Co.  
Weston Elec. Inst. Co.  
Wireless Press



### "GREBE RADIO"

Grebe CR-3 Receiver, 150-1000 meters.....	\$65.00
Grebe CR-5 Receiver and Vacuum-tube Unit, 150-3000 meters.....	\$80.00
Grebe CR-8 Receiver and Vacuum-tube Unit, 150-1000 meters.....	\$80.00
Grebe CR-9 Receiver, Detector and Two-stage Amplifier, 150-3000 meters.....	\$130.00
Grebe CR-10 Radiotone Concert Receiver, Detector and Three-stage Amplifier, Victrola type.....	\$315.00
Grebe RORK Two-stage Amplifier.....	\$55.00
Grebe RORD Detector and Two-stage Amplifier.....	\$75.00
Grebe RORN Tuned Radio Frequency Amplifier.....	\$60.00

"Without going out of doors," said Lao-Tzu, "one may know the whole world." "Let a GREBE RECEIVER bring the whole world to your evening fireside."

**DEALERS—Attractive discounts and immediate deliveries from stock! Send for Our Latest Price List, No. 3.**

**"F. D. PITTS CO. NEW ENGLAND DISTRIBUTORS OF GREBE RADIO"**

# HOMCHARGE

Your  
RADIO  
BATTERY  
for  
A NICKEL

Enjoyable concerts and maximum receiving range are obtained only when your battery is fully charged.

## THE HOMCHARGER

charges your "A" or "B" battery over night for a nickel without removing it from your living room. No muss — no trouble — no dirt — requires no watching

After the concert connect to any lamp socket, snap the clips on your battery and "turn in" While you sleep the HOMCHARGER is silently charging your battery, the charging rate being governed automatically. In the morning it is fully charged. No other battery charger can boast of such quick and economical performance.

The HOMCHARGER is the only battery charger combining all of these NECESSARY HOMCHARGING features — SELF-POLARIZING — FIVE to EIGHT AMPERE charging rate — UNDERWRITERS' APPROVAL — beautifully finished in mahogany and old gold — UNQUALIFIEDLY GUARANTEED. Over 60,000 NOW IN USE.

Sold complete with ammeter, etc. by all good radio and electrical dealers for \$18.50 (\$25.00 IN CANADA).

See the RADIO HOMCHARGER DELUXE at your dealers or write direct for our FREE circular showing why the HOMCHARGER is the BEST battery charger at any price.

**MOTORISTS** — The HOMCHARGER will also charge your AUTO battery.

### The Automatic Electrical Devices Co.

118 West Third Street  
Cincinnati, Ohio

Largest Manufacturers of Vibrating Rectifiers in the World

## Tunes, Sounds and Slogans Are Becoming Popular

(Continued from page 1639)

receivers, it is sure to be WDAJ broadcasting. The Naval Station at Anacostia, NOF, is known by the deep bass voice of the announcer.

It is not only in the Southland that these slogans and phrases have become popular; farther west we have the Palmer School of Chiropractic at Davenport, Iowa. "This is WOC" the announcer states. "Out where the West begins." Another station identifies itself with: "Out where the corn grows tall." The voice of the spokesman at WOH the Hatfield Electric Co., at Indianapolis, might confuse one at first, it sounds so southern and is similar to that of WSB in Atlanta. Who says "Ayand?" The pronunciation of the simple word "and" would hardly locate a station, but ask anyone who has heard "MR." KDKA at Pittsburgh, and see if they will not admit that the drawled "ayand" is a positive identification? The voices of the evening story tellers are all well known by the small radioites.

## A Specially Designed Broadcast Receiver

(Continued from page 1646)

as that on the stator of the variometer, so that the magnetic fields of these two windings will be in inductive relation to each other rather than opposing each other.

After the secondary has been finished, a quarter of an inch space should be left and then the primary wound on. The primary consists of 10 turns of No. 22 D.C.C. wire wound in two layers. The first layer contains six turns. On top of this is wound a second layer of four turns, making a total of 10 turns in all. No attempt is made to tune the primary. It is wound in two layers to broaden its tuning effect, and to still further broaden it, it should be given a good coat of shellac. The idea is that the untuned primary responds to all the wave-lengths within its range and the tuned secondary then picks out the particular wave-length on which the operator wishes to receive. The proper number of turns on the primary will vary somewhat according to the size of the aerial with which it is used. Ten turns were found to be about the best for an aerial 40' high and 60' long.

The hook-up is shown in Fig. 4. It will be noticed that regeneration is obtained not only by means of the tuned plate system with the variometer, but also by a certain amount of feed-back through the inductive coupling between the secondary and the variometer. In the amplifier circuit the action of the one-step—two-step change-over switch is quite apparent. With regard to "B" batteries, experience has taught that best results are usually only obtained by using separate "B" batteries in the detecting and amplifying circuits.

The results obtained with this set have been exceedingly gratifying. The builder uses a loud speaker in conjunction with the two step amplifier and hears many broadcasting stations all over his operating room. In fact, some of the closer ones are heard all over the house. This receiving set is located at Toronto, Canada, and broadcasting stations are heard from all over the continent. A partial list of the places from which broadcasting stations are heard with this set is as follows:

Lockport, N. Y.; Buffalo, N. Y.; Schen-

# SOMETHING

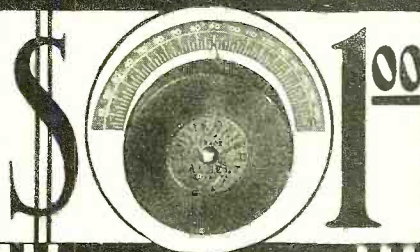

## NEW

Get the fine selectivity with your set that you've been looking for!

The UNIVERNIER combines in one single unit both coarse and ultra-fine adjustments! It is a universal vernier attachment, a generous sized knob 2 1/2 inches in diameter of polished bakelite composition, with a simple self-contained mechanism, so arranged that rotation of the knob is nearly 12 times that of the shaft of the instrument, giving extra fine selectivity. Pressure towards the panel permits ordinary coarse adjustment, thus combining rapid and delicate adjustment in one unit. Indicator rotates with the shaft, always indicating true position of the instrument.

The UNIVERNIER'S installation on any set is as simple as that of an ordinary knob. Used on Variometers, Variable Condensers, Couplers, Potentiometers, and Rheostats.

Send No Money.—Mail us your order today for one or half a dozen—and pay the postman one dollar for each when delivered! Be the first to get this wonder adjuster! Made in two sizes: No. 251 for 1-4 inch shaft; No. 188 for 3-16 inch shaft. Dealers and Jobbers write for discounts.

WALBERT MFG. CO.

925-41 Wrightwood Ave. Chicago, Ill.

# UNIVERNIER

## \$3 makes your PHONOGRAPH the best loud speaker



Unscrow Head Phone Cap and Replace with Huguenot Sizes to fit all Standard Phones

Fits All Standard Phonograph Tone Arms For Special Makes use Bushing 50 Cents Extra

### HUGUENOT RADIO PHONOGRAPH ATTACHMENT

No Metal Parts to Bend  
No Leaks or Loose Connections  
Quickly and Easily Attached  
Made of Black Polished Hard Rubber  
Double Phone Attachment.....\$3.00  
Single Phone Attachment.....\$1.00

Mail orders filled promptly on receipt of remittance. Specify make of phonograph and head-phones.

MCKENZIE ENGINEERING COMPANY  
NEW ROCHELLE, N. Y.

Dealers—Order from Your Usual Jobber  
Special discounts to the trade.

AMPLIFY WITH YOUR PHONOGRAPH



# Know Who Is Sending

Get twice the pleasure and usefulness out of your receiving set. Look up the name and location of any ship or land station whose messages you pick up—learn the name and address of that amateur whose sending set you just heard.

## 4th EDITION OF THE CONSOLIDATED RADIO CALL BOOK

In a new large size — 280 pages — 88 more valuable pages than the 3rd Edition and featuring

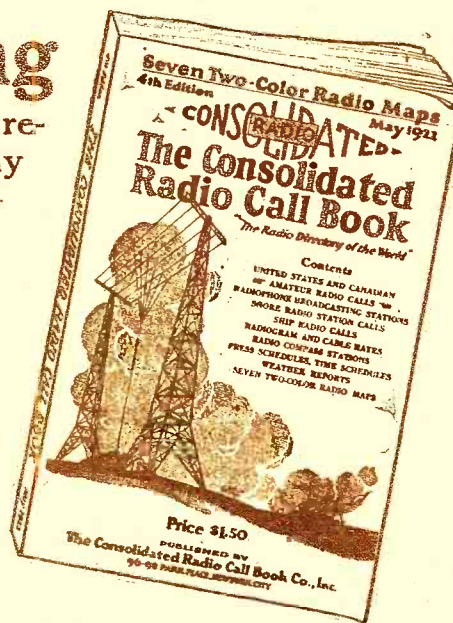

### —7 Two-Color Radio Maps

Five of them are Continental Maps showing all stations throughout the world handling commercial traffic, with their calls; one showing the amateur radio districts of the United States and the principal radiophone broadcasting stations with their calls; and a map of the United States Weather Forecast Zones. Seven wonderful, two-color radio maps with a wealth of information that will give you a great deal of pleasure and knowledge.

## Every Amateur Call in the U. S. and Canada is Listed Besides Other Valuable Information Contained in This New Book

All Amateur Radio Calls of the United States and Canada; Every Vessel, Coast Station, and Radio-Compass Station in the World; Radiophone Broadcasting Stations of the United States; Every High-Power Station in the World, Special Land Stations of the United States; Time Signals. Hydrographic and Weather Reports of the United States and Principal Foreign Countries, International Abbreviations; Assignment of International Calls; Press Schedules; Radiogram Rates; Cable Rates; International Morse Code and Continental Signals; and Complete General Information covering Distress Calls, International Safety Signal, Use of 800-Meter Wave Length, Amendments and Changes in Various Government Regulations, How to Determine Charges on Radiograms, Free Medical Advice by Radio to Vessels, and much other useful information.

**\$1.50**  
**1**  
Prepaid

And every vessel and land station in the world is represented and listed alphabetically, according both as to name of vessel or land station, and to letters. The Consolidated Radio Call Book is the only book in print officially listing all the Radio calls as issued by the Bureau of Commerce. And the New Radiophone Broadcast Section is particularly complete and gives all available information concerning calls, wave lengths, PROGRAMS, etc.

The third edition of 10,000 copies was exhausted in two weeks. The fourth edition is selling just as quickly. Don't wait until it is all gone. Order at once, either direct from us or from your favorite dealer.

Published by

**Consolidated Radio Call Book Co., Inc.**  
96-98 Park Place, New York City

## Great 40-Page Supplement FREE to all who have the 4th Edition Call Book

As a special service to the readers of the Fourth Edition of the Radio Call Book, we have printed, at great expense, a 40-page supplement containing the latest amateur radio calls of both the United States and Canada, and other calls issued very recently. It is absolutely free to all those who write for it, provided you have bought a copy of the fourth edition of the Consolidated Radio Call Book. This wonderful supplement brings the call book up to the very last moment and on account of the many changes that have taken place and which are fully covered by this supplement, every radio amateur or professional is urged to send for his free copy of this supplement today.

Send to us direct or get it from the dealer from whom you bought the 4th Edition Call Book.

# RICO

TRADE MARK  
REG.

## THE FIBRE "RICOHORN"

### LOUD

This presents the latest development in loud talker horns. It has been realized by every acoustic expert that metals should never be used in connection with loud talkers, as they give rise to "metallic" sounds.

"Ricohorns" are made entirely of fibre. No metal is used at all, the sounds come through not only mellow and undistorted, but, due to the higher amplifying power of fibre, much louder as well.

"Ricohorns" are unbreakable. Cannot be dented and do not lose their shape. At the price listed, each unit is equipped with our regular "RICO" Loud Speaker 'Phone with cord, listed on the opposite page. By means of an ingenious arrangement, this 'Phone is clamped against the lower extremity of the "Ricohorn" in such a way that no echo pockets are formed. Consequently there is nothing lost in the emission of the

### SPEAKER

sounds. The RICO Loud Speaker 'Phone can be dismantled, if desired, in less than a minute's time. While we sell this unit complete with the "RICO" Loud Speaker 'Phone and cord, we are also listing the horns without 'phone, so the user may use his own 'phone if he so desires. It is possible with Rico horns to use any 'phone, no matter what its make.

The finish and material of our horns are of the highest grade throughout. The base to which the horn is attached is of metal. The horn itself has a beautiful black mottled appearance, which lasts practically forever. The base is finished in the same black finish. "Ricohorns" are put up in strong corrugated cardboard boxes, we insure safe delivery.

No. 111 Fibre "RICOHORN", with "Rico" Loud Speaker 'Phone height 23", bell 10", each .....\$12.50  
No. 11 Fibre "RICOHORN" only without Loud Speaker 'Phone, height 23", bell 10", each .....\$10.00



**\$12.50**  
**COMPLETE**  
With  
**"RICO"**  
**L. S. PHONE**

This horn stands 23" high, bell 10". Made entirely of fibre, metal base.

## THE "RICO" PHONODAPTER

75c



This adapter fits Columbia, Victor, and Sonora phonographs. Is made entirely of pure rubber, with brass tube insert.

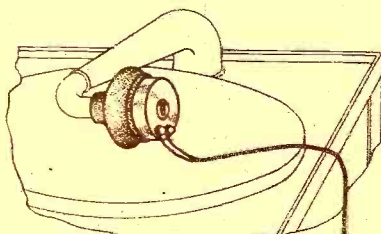

"Rico" PHONODAPTER fits any standard phonograph.

Since selling our "Rico" Loud Speaker 'Phone we have had a tremendous demand for an adapter by which a 'Phone can be adapted to any phonograph. Our new Phonodapter is the result of this demand. Kindly study our illustration carefully, you will find that the "RICO" Phonodapter presents many unique advantages over other similar adapters. In the first place, the entire adapter is made of pure rubber and will stretch over any make of 'phone. It has, however, been especially developed for the "RICO" Loud Speaker 'Phone. This adapter does not give rise to echoes, as is the case with most of the others that we have examined. There are no echo air chambers left after the adapter is attached to the 'phone, as is the case with so many others.

Study the illustration carefully and become convinced why ours must be better than most others. The illustration also shows the brass tube inserted in the smaller part of the Phonodapter. With this brass tube the Phonodapter fits all Columbia phonographs. By removing this tube, the Phonodapter fits Victor, as well as Sonora phonographs. It will be seen, for this reason, that the Phonodapter is a universal article, which must appeal instantly to every one.

#### OTHER USES

The above, however, does not exhaust the uses of the "RICO" Phonodapter, because it can be used in connection with standard horns. It is realized that it is almost impossible to fit the "RICO" Loud Speaker 'Phone, or, for that matter, any receiver, to a horn, if you should happen to have such, without an adapter. The "RICO" Phonodapter can be used to couple any 'phone to a horn, if you have a spare horn lying about. Or if you know where you can obtain one, the Phonodapter, will solve your difficulty. If you do not wish to go to the expense of a horn, and wish to improvise one it can be easily made by rolling and pasting together a sheet of stiff Bristol Board and fashioning it into a horn. If the lower extremity is fitted over the brass tube of the "RICO" Phonodapter you will at once have a horn which in an emergency will prove quite satisfactory. Such horns can be made as large as desired. We guarantee the Phonodapter to do all that we say, and shall cheerfully refund the purchase price if it is not found satisfactory in all respects.

No. 131 "RICO" Phonodapter, as described, each, \$ .75  
prepaid .....

With brass tube fits COLUMBIA. Without it fits VICTOR and SONORA phonographs.

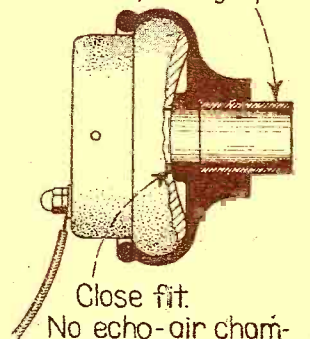

Close fit.  
No echo-air chamber here.

**RADIO**  
**INDUSTRIES**  
CORPORATION  
131 Duane St.  
**NEW YORK CITY**  
Cable Address—RicoTrade, N. Y.

# THE "RICO" LOUD-SPEAKER PHONE

Clear as a Bell

A Remarkable Phone

Here is the loud-speaker phone for which you have been waiting! For the first time you are now able to buy a single 2,000-ohm loud-speaker phone that has been planned by radio and acoustic engineers for one purpose, and one purpose only—namely, to reproduce sounds clear and loud through a horn.

Used in any standard horn, it will amplify the weakest of sounds so that the whole family can hear your radio all over the house. Furnished complete with a five-foot (5 ft.) cord. The RICO LOUD-SPEAKER PHONE will prove a revelation to you, if you have used regulation head receivers for loud talkers. We are so convinced that you will be enthusiastic about this phone that we make this

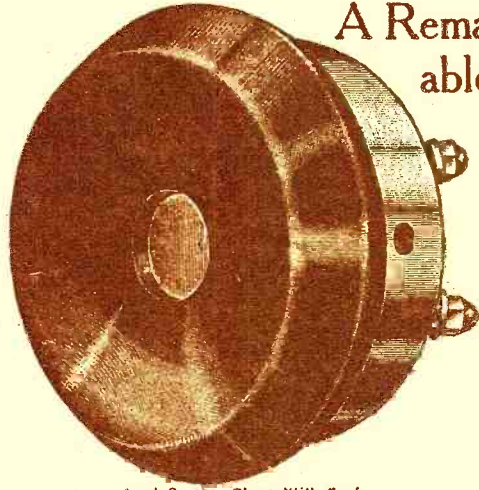

Loud Speaker Phone With Cord

A Remarkable Price

\$4.50

SEND NO MONEY

Just write us and tell us that you wish one or more (choose any type) of these phones, and we shall rush the order to you at once. Pay your postman the price of the phone and then test it out at our expense.

USE COUPON BELOW

NOTE: The RICO Loud-Speaker No. 25 Phone must be used in connection with a 1- or 2-stage amplifier or more.

Note the new construction. The pull in the center of the diaphragm is where it should be, in the mathematical center. The result: Clear and loud tones, NO DISTORTION.

## SPECIAL OFFER:

Try this LOUD-SPEAKER PHONE for five days, and simply consider the money you are sending in to us as a deposit. If, at the end of five days, you are not convinced that it is the best loud-talker phone you have ever seen or heard return it to us and your money will be promptly refunded.

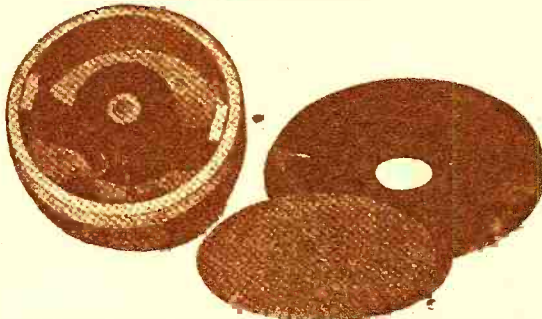

RICO Phones achieve remarkable results, due to the three poles. The only ones that have return circuit through the diaphragm, with the magnetic pole in the mathematical center of the diaphragm.

## "RICO" "Super-Sensitive" Phones

This Phone comprises two of our Loud-Speaker Phones, described above, with our stock headband and cord. The resistance is 4,000 ohms, and is made especially for use with vacuum tubes. Not suitable for crystal outfits. Note particularly that this set of receivers has the two receivers connected in parallel, not in series, as is usual with other receivers. The parallel connection gives double the intensity: this phone will surprise you with its extremely powerful volume of sound. No. 40, Super-Sensitive Double Headset, each \$9.50

## WHAT THEY SAY

Gentlemen:—The RICO receiver received and I have given it about ten days' hard test and find it everything that you claim for it. It sure is a wonderful instrument. It is the best receiver I ever have seen. It will go to the highest and down to the lowest note without a vibration. I have recommended it to several other parties and you may expect more orders from the sale of this one. I am using it in a Lober Loud Speaker horn.

O. J. GARN,

1232 Lincoln Ave., Toledo, O.

Gentlemen:—I received your Loud Speaker Phone (No. 25) in excellent condition and can say that all you say for your phones is true. I am only using 1 stage of audio frequency and we can hear the city stations all over the house on your phone. Thanking you for your prompt delivery, I remain,

FRANK C. HEYMER,

2325 W. Huntington St., Philadelphia, Pa.

## PRICE LIST

Parcel Post—Paid Anywhere in North America

No. 25 Special Loud-Speaker Phone with cord	\$ 4.50	No. 75 75 ohms Double Head Set	\$5.00
No. 20 2000 ohms Double Head Set	5.00	No. 5 5 ohms Double Head Set	5.00
No. 30 3000 ohms Double Head Set	5.50	No. 2 1000 ohms Receiver only	2.00
No. 40 4000 ohms Double Head Set	9.50	No. 3 1500 ohms Receiver only	2.25
No. 10 1000 ohms Single Head Set	3.50	No. 05 5 ohms Receiver only	2.00
No. 15 1500 ohms Single Head Set	3.25	No. 075 75 ohms Receiver only for Telephone work not for radio	1.00



Rubber Head Band

Rico No. 20, 2000 ohm Double Head Set with pure rubber covering. Now \$5.00  
Rico No. 30, 3000 ohm Double Head Set with pure rubber covering. Now \$5.50

\$ 5.00

**RADIO INDUSTRIES CORPORATION**

131 Duane Street  
NEW YORK CITY

California, Washington and Oregon Distributors: Western Agencies Inc. 711 Mission St. San Francisco, Cal.

Mail your order at once, if the dealer can not supply you. Insist upon RICO Tri-pole. There is a very good reason why you should use RICO phones, and that is they are different—not merely Phones, but

Phones built for Radio purposes.

---SEND NO MONEY---

COUPON

R.N.3

Radio Industries Corporation,  
131 Duane Street, New York

Gentlemen:

Please send me prepaid \_\_\_\_\_ for which I will pay the postman the amount advertised in these pages. (NOTE: "Phonadapters," due to the very low price, cannot be sent C.O.D.) If within five days I do not find the goods all you claim for them, or if for any reason I am not satisfied, I may return same to you in good condition and you will refund the full purchase price.

NAME \_\_\_\_\_

STREET AND NO. \_\_\_\_\_

CITY \_\_\_\_\_

STATE \_\_\_\_\_

# A Chemistry Laboratory for \$7.00

Think of it, fellows! Here is a real chemistry outfit with regular chemical apparatus that performs those fascinating, actual chemical experiments.

This outfit is not a toy, put up merely to amuse, but a practical laboratory set, with all the chemicals, apparatus and reagents necessary to perform real work and to teach the beginner all the secrets of inorganic chemistry. With this outfit we give free a book containing a Treatise in Elementary Chemistry, useful data and recipes, and 100 instructive amusing experiments.

## DESCRIPTION OF THE OUTFIT

The outfit consists of forty-four (44) chemicals all C. P. (chemical pure) put up in appropriate wooden boxes, glass bottles and hermetically closed jars. The acids are put up in glass bottles, with ground-in glass stoppers, and there is a sufficient quantity of chemicals supplied (mostly one to two ounces) enough to make dozens of experiments with each.

The apparatus furnished are all of the best obtainable make and of standard laboratory size and shape. 17 pieces of apparatus furnished with this outfit.

The instruction book is a real Chemistry Course for the Beginner. Some of the Contents

are: Division of Matter: This is a Treatise on Elementary Chemistry, and deals with the theory of the Elements, Molecules and Atoms, etc.

## 100 EXPERIMENTS

How to make chemical tricks; how to make invisible and magic inks; how to test flour; how to test soil; how to make chlorine gas and smoke (German War Gas); how to bleach cloth and flowers; how to produce oxygen and hydrogen; how to make chemical colors; how to test acids and alkalis, and hundreds of interesting hints and formulas.

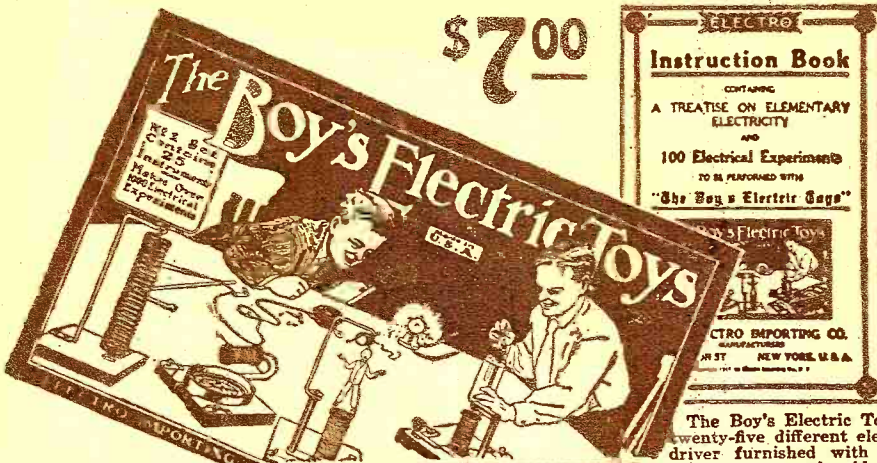
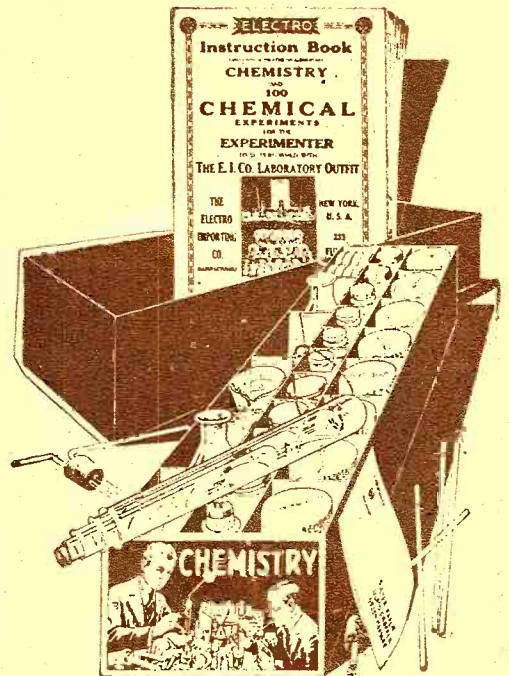

Every Fellow Wants the

# BOY'S ELECTRIC TOYS

The Boy's Electric Toy contains: Enough material to make and complete over twenty-five different electrical apparatus without any other tools except a screwdriver furnished with the outfit. Student's chromic plunge battery, compass-galvanometer, solenoid, telephone receiver, electric lamp. Enough various parts, wire, etc., are furnished to make the following apparatus:

Electromagnet, electric cannon, magnetic pictures, dancing spiral, electric hammer, galvanometer, voltmeter, hook for telephone receiver, condenser, sensitive microphone, short distance wireless telephone, test storage battery, shocking coil, complete telegraph set, electric riveting machine, electric buzzer, dancing fishes, singing telephones, mysterious dancing man, electric jumping jack, magnetic geometric figures, rheostat erratic pendulum, electric butterfly, thermo electric motor, visual telegraph, etc., etc.

This does not by any means exhaust the list, but a great many more apparatus can be built actually and effectually.

With the instruction book we furnish one hundred experiments that can be made with this outfit, nearly all of these being illustrated with superb illustrations. No other materials, goods or supplies are necessary to perform any of the one hundred experiments or to make any of the 25 apparatus. Everything can be constructed and accomplished by the means of this outfit, two hands and a screwdriver.

The outfit contains 114 separate pieces of material and 24 pieces of finished articles ready to use at once.

We guarantee satisfaction. The size over all the outfit is 14 x 9 x 2 1/2. Shipping weight, 8 pounds. "The Boy's Electric Toys" outfit as described, \$7.00. Immediate shipment.

**SEND FOR YOUR SET TODAY**

**REMEMBER**

**JUST CLIP THE COUPON—DON'T SEND MONEY**

**ELECTRO IMPORTING CO., 233 Fulton St., New York City**

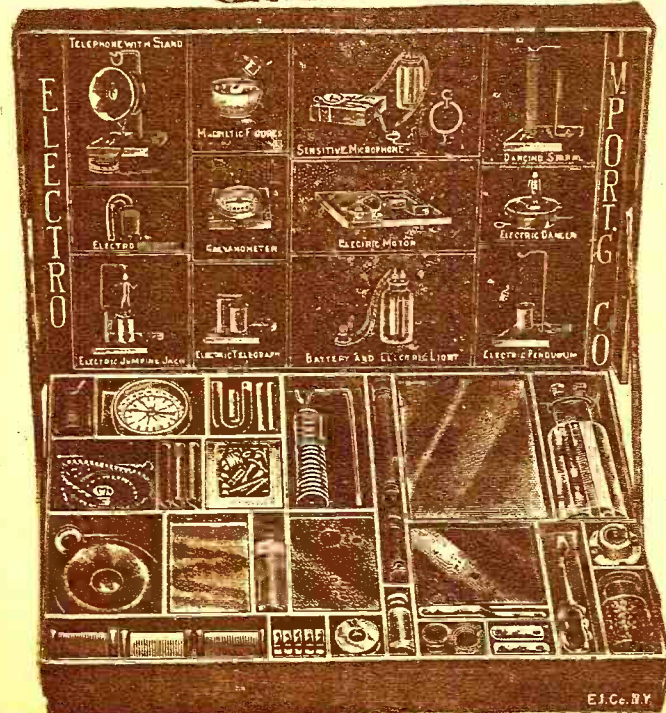

ELECTRO IMPORTING CO.,  
233 Fulton St., New York.

Please send me by express THE CHEMICAL LABORATORY. If I don't like it I need not accept it. If I want it I only pay \$7.00 plus the few cents express charge.

.....

.....

ELECTRO IMPORTING CO.,  
233 Fulton St., New York.

Please send me by express THE BOY'S ELECTRIC TOYS. If I don't like it I need not accept it. If I want it I only pay \$7.00 plus the few cents express charge.

.....

.....

(Continued from page 1724)

ectady, N. Y.; New York City; Detroit, Mich.; Pittsburgh, Pa.; Chicago, Ill.; Newark, N. J.; Springfield, Mass.; Atlanta, Ga.; Louisville, Ky.; Davenport, Iowa; Fort Worth, Tex.; Kansas City, Mo.; Montreal, Que.; and Winnipeg, Man. 'Nuff Sed!

### Lightning Switch Indicator

(Continued from page 1656)

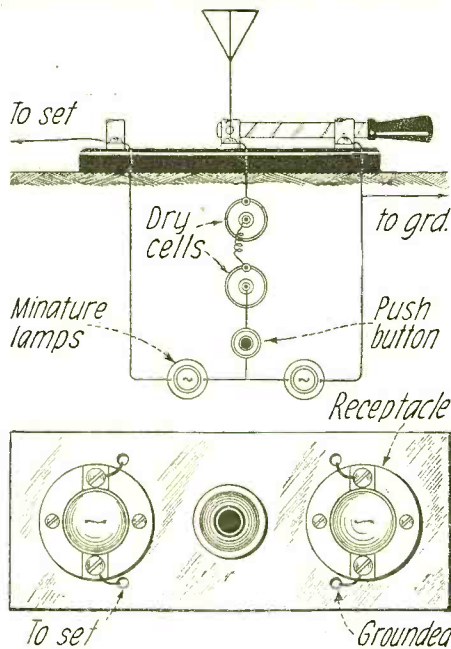

These Tell-Tale Lights Will Instantly Determine for You the Position of Your Lightning Switch. Just Push the Button.

The indicator I am about to describe consists of two small bulbs in miniature receptacles, with a push button between. The words "Connected to Set," are under one bulb and "Grounded," is under the other. When the button is pushed, the one that lights up indicates the position of the switch by the reading under it.

The hookup shows clearly how the bulbs, push button and switch are connected to a suitable number of dry cells.

When you want to know what position the switch is in, push the button.

Contributed by R. Carsten.

### Interference

(Continued from page 1620)

of your troubles will go with it. Therefore, we will turn our attention to the amateur on the corner and see if he can be tuned out.

His station is radiating a great deal of energy, relatively, considering the distance, and the energy intercepted must necessarily traverse your antenna and ground system. I have found that a loop will not in any direction eliminate successfully that amateur C.W. station, because an inductively coupled circuit used with a loop is too sharp in tuning and causes too great a reduction in signal strength. Without the inductively coupled circuit the energy traverses your set and the signals are troublesome, though this is a considerable improvement over the outside antenna.

The wave trap is not a success, as far as my experience is concerned. The signals are reduced, yet the music and speech still "jump" with every movement of his key. An outside loop with an inductively coupled circuit eliminated his signals, but

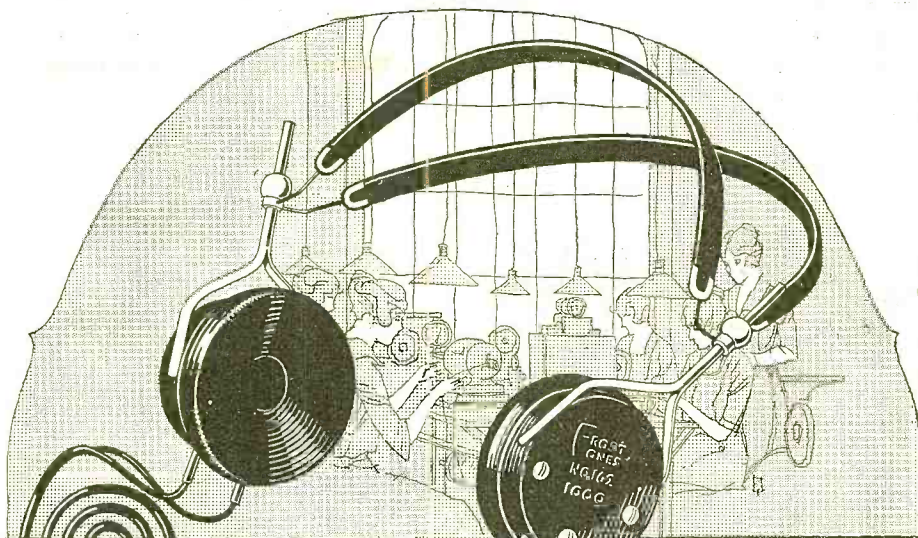

## Super-Inspected Quality

**F**ROST Fones always have been true to an engineering ideal. Built for precision and sensitivity, they quickly won national repute.

Today Frost Fones are the largest selling head fones in the world. Frost ideals of quality—of precision in manufacture—of rigid inspection during every stage of the making of these famous Fones—insure permanent satisfaction to every one who buys a pair.

Each item in the Frost Radio line is made up to highest standards of radio engineering. You can order Frost Fones, Plugs, Jacks, and other apparatus from your dealer with the certain assurance that your money buys the best that can be made, at prices which only quantity production make possible.

No. 162  
2000 Ohm Set  
**\$5.00**

No. 163  
3000 Ohm Set  
**\$6.00**

Your dealer  
sells  
Frost Fones  
See him today



## HERBERT H. FROST, Inc.

154 WEST LAKE STREET, CHICAGO, ILLINOIS.

# ❖ RADIO ❖

Complete Stock—Both Sets and  
Parts—All Makes

## ROSE RADIO SUPPLY

129 CAMP STREET  
New Orleans, La.

Send 10c for latest catalog



**DeForest Chooses the  
RADIO STORES  
VARIABLE  
CONDENSER**

*For Use in All New Sets*

Counter weight under dial.  
Brass studs through alumi-  
num plates. Die cast. Shaft  
held true center through  
brass bushings. Binding  
posts mounted on metal  
straps. No insulation tapped  
—inserts throughout. Preci-  
sion workmanship—best en-  
gineering design.

23 Plate, .0005 mid. Capacity ratio 28 to 1 \$4.25  
43 Plate, .001 mid. Capacity ratio 46 to 1 \$4.75

**IMMEDIATE SHIPMENTS**

**RADIO STORES CORPORATION**  
National Distributors and Manufacturers  
218-222 WEST 34th St., NEW YORK CITY

MONEY FOR YOU—Add to your salary—Make extra pin money—Start a lucrative business of your own. Spend an hour each day taking subscriptions for the Radio News. We'll pay you well and you'll enjoy the work. Write for full particulars. Circulation Dept., RADIO NEWS, 53 Park Place, New York City.

## Making the most of Radio with DUBILIER products



Screw the Dubilier Ducon into any lamp-socket and the broadcasting station comes in strong and clear. No antenna or loop is required.

No antenna, no loop—just the Ducon in a lamp socket

Price, at your dealer, \$1.50.

### Dubilier Micadons Reduce Tube Noises

Dubilier Micadons are mica condensers which are permanent in capacity. Hence they reduce tube noises due to fluctuations in capacity and greatly improve the reception.

Dubilier Micadons are made in types to meet every radio need. The price varies from 35 cents to \$1.00 each, depending on the capacity.



Micadon type 601. Connect by means of eyelet terminals to obtain the desired capacity. Price 35 and 40 cents each.

Micadon type 600. Molded case. Price 75 cents and \$1.00 each, depending on capacity.

BRANCH OFFICES

San Francisco, Cal. .... 709 Mission St.  
 Washington, D. C. .... Munsey Bldg.  
 St. Louis, Mo. .... Syndicate Trust Bldg.  
 Chicago, Ill. .... 33 So. Clinton St.  
 Atlanta, Ga. .... Forsyth Bldg.  
 Seattle, Wash. .... 1926 L. C. Smith Bldg.  
 Pittsburgh, Pa. .... 704 Granite Bldg.  
 Los Angeles, Cal. .... 337 South Western Ave.  
 Huntington, W. Va. .... 1028 Fourth Ave.

## DUBILIER

Condenser & Radio Corp.  
 48-50 West 4th St., N. Y.  
 Canadian Distributors: Canadian General Electric Co., Ltd., Toronto, Canada

TRADE MARK



GALENA CRYSTAL

Galena Crystal, Mounted ..... 35c  
 Galena Crystal, Unmounted ..... 25c

IMMEDIATE DELIVERY

Manufacturers, Jobbers, Dealers,  
 Write for quantity prices

GALENA CRYSTAL MFG. CO.

2894 Fulton Street      Brooklyn, N. Y.

If

you can't get it elsewhere, try New York's Radio Center.  
 Standard Sets and Parts  
 We quote prices gladly.

Electric Service Engineering Co.

105 West 47th St. New York City

almost eliminated everything else when the coupling was sufficiently loose to suffice.

I found that there was only one satisfactory solution and that was a very loose coupling in connection with the outside antenna and ground. I used two coils, separated about 12 to 15 inches, as primary and secondary, and by very careful tuning picked up stations consistently 500 to 1,000 miles distant without any but a slight knock from the amateur station and otherwise remarkably clear hearing, with almost total absence of interference.

The winter months will soon go by and summer with its static will be here. The broadcast fan had best prepare now for that situation. A tuning device that will eliminate static by selectivity will also be very, very useful when the amateur on the corner begins working. It is rather a simple matter to arrange your set so as to switch over from the single to the two-circuit type of tuner and it will save your temper and rid Congress of some of its radio troubles. We are too good a class of sportsmen to ask legislation prohibiting the use of shotguns in duck-hunting because we have only a 22 caliber rifle. Eventually the same spirit will prevail in radio. Why not now?

Fig. 1 shows a circuit which, however, is not new.

It is merely an adaptation of the familiar honeycomb coil hook-up.

The operation of this circuit is as follows: To use as a single circuit, close switch x at B, open switch y, close switch z at D. Condenser C<sub>1</sub> is now in the antenna. The coil S, which probably would have about 35 turns, is of the correct dimensions for broadcasting with the condenser in series. Now we will suppose that interference begins. Simply close switch x at A, close switch y at C, close switch z at E. Coil P now becomes the primary. Coil S is the secondary with the secondary condenser in shunt. There will be no need to substitute another coil for the secondary, as the secondary condenser, C<sub>2</sub>, is now in shunt and if this coil is of the proper dimensions it will operate satisfactorily in both circuits. Moreover, by a little experiment it may be made of such dimensions that it will nicely cover all broadcasting wave-lengths with C<sub>2</sub> of .001 mfd., whether the coil is used as a primary or secondary. With this latter switching operation the circuit becomes a very selective one, provided that a very loose coupling is used between coils P and S. The condenser C<sub>1</sub> may be dispensed with and tappings from the coil P are not necessary if it is of proper dimensions. The primary circuit is not critical. The secondary circuit is very critical and it is likely that a vernier adjustment or a vernier condenser in parallel (or variable of three plates) will be necessary.

This is shown as a single tube set. Audio frequency amplification may be added. If amplification is used, and a very loose coupling maintained between coils P and S, then make sure that your amplification units are quiet in operation. The signals are somewhat reduced in strength with a very loose coupling. As a test, reduce the filament temperature on the detector tube to zero and listen in on the second stage. If you hear crackling noises, the trouble is probably in your transformers or in poor connections, though it may be battery trouble. These noises will continue just as strong in one circuit as another, but will become much more troublesome with reduced signals and you cannot obtain the remarkably clear hearing that is otherwise characteristic of this very loose coupled circuit. It is my experience that there is little excuse for internal noises in the set using only two stages of audio frequency. To construct the above tuner, for the

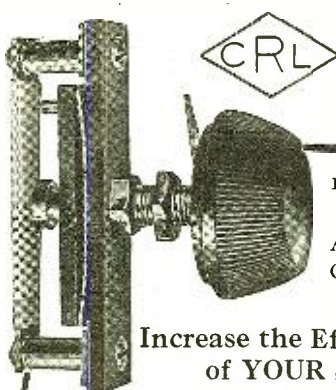

CRL

Pat. Apld. For  
**CRL**  
 Adjustable  
 Grid Leak

### Increase the Efficiency of YOUR Set

A CRL Adjustable Grid Leak will surprise you by the way in which it increases the efficiency of your set. A turn of the polished black knob will enable you to get the one and only correct potential of the grid that provides the maximum signal strength. There is no guesswork about it—no time lost in preliminaries.

Every CRL Adjustable Grid Leak is designed for mounting a standard grid condenser conveniently between the binding posts. (See illustration above.)

No. 106 (without condenser) ..... \$1.50  
 No. 107 (with condenser) ..... 1.85

If your dealer cannot supply you, we'll supply you direct if you include 10c for packing and postage.

## CENTRAL RADIO LABORATORIES

Makers of C R L Rheostats, Vernier Rheostats, Potentiometers, Vernier Potentiometers and Grid Leaks.

305—16th Street  
 Milwaukee      Wisconsin

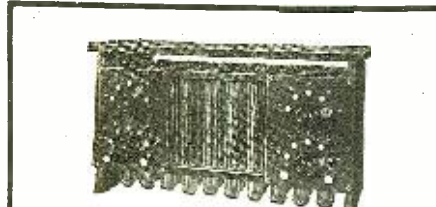

## KICO

Radio Storage "B" Batteries  
 for EFFICIENT Receiving

THINK over the following FACTS before buying again.

1. KICO "B" batteries allow single cell variations by means of switches on mounted panels. (The first in the market with this feature.)
2. Alkaline type.
3. One charge lasts from three to six months in the detector plate circuit.
4. Rechargeable from your 110-volt A. C. line in connection with the rectifier supplied.
5. Neat, efficient and compact.
6. Unlimited life.
7. Your money back if unsatisfied within a 90-day trial.

		(Plain)	(With Panels)
16 cell	22 volt	\$6.50	
24 cell	32 volt	8.00	\$12.00
36 cell	48 volt	10.00	14.00
50 cell	68 volt	12.00	17.00
78 cell	100 volt	16.00	21.00
108 cell	145 volt	21.00	26.00

Literature gladly furnished.

## KIMLEY ELECTRIC CO.

1355 Fillmore Avenue      Buffalo, N. Y.

### A WONDERFUL OPPORTUNITY

The Eastern Division of the RADIO CORPORATION OF AMERICA accept no inexperienced applicants in their services as Wireless Operators other than our graduates. Investigate the advantages offered through taking either our HOME STUDY or RESIDENCE course in Radio.

## RADIO INSTITUTE OF AMERICA

(Formerly Marconi Institute)

324 Broadway      New York City

average fan building parts of his own set, the expense is very small. Honeycomb coils are satisfactory, but since they come in turns of 25, 35 or 50, it is better to construct your own.

For this purpose I use a piece of broom pole across two curtain pole brackets. I sliced rings from a cardboard tube, each ring about an inch in width and used them for forms.

Only a few minutes are required to wind a number of coils. The ends of wire are tied around the ring and may be connected to binding posts on the edge of the table. After testing a coil the number of turns may be altered without any trouble until the proper number of turns is determined.

The coupling is varied by sliding the coils back and forth on the pole. With very loose coupling there is little capacity reaction in moving the tickler and hence the usual detuning effect is not noticeable in adjusting the regeneration, provided the filament rheostat is used effectively. To produce oscillation at low filament temperature and thus obtain a loose coupling between coils S and T, at regeneration, the grid and phone condensers may be of capacities .001 mfd. and .005 mfd., respectively. I use a grid condenser of capacity .0017 mfd.

The additional advantage of this circuit is its great flexibility. Coils of any dimensions may be substituted for higher wave-lengths. Incidentally this may be an important consideration if Congress should enact pending legislation, and broadcasting should begin on wave-lengths beyond the range of present types of receivers.

In addition, a variocoupler may be connected in place of the coils, setting the switches for a single circuit. The rotor replaces coil T and the stator replaces coil S. For longer waves you may resurrect that old loose coupler and connect the primary in place of coil S and the secondary in place of coil T. For still longer waves, unmounted honeycombs may be substituted in the circuit.

In my set I actually have another switch which enables me to use the condenser C<sub>2</sub> either in shunt or series in the single circuit arrangement, thus increasing the wave-length range and making it unnecessary to change coils in many instances when operating the single circuit.

In conclusion, much of the interference and the static may be eliminated and you will have the single circuit conveniently accessible when needed.

### An Improvement

(Continued from page 1645)

The coil wire was cut in two at a point midway between the ends. A few turns were then unwound at each cut end to

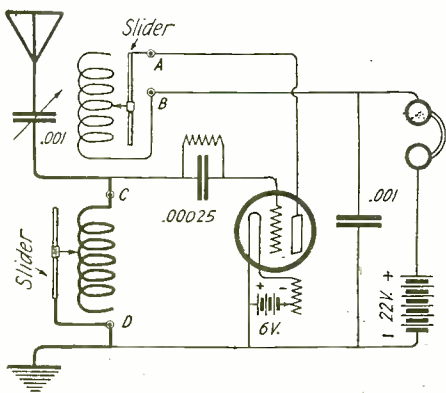

The Circuit of the Improved Set Described. A Split Tuning Coil is Used.

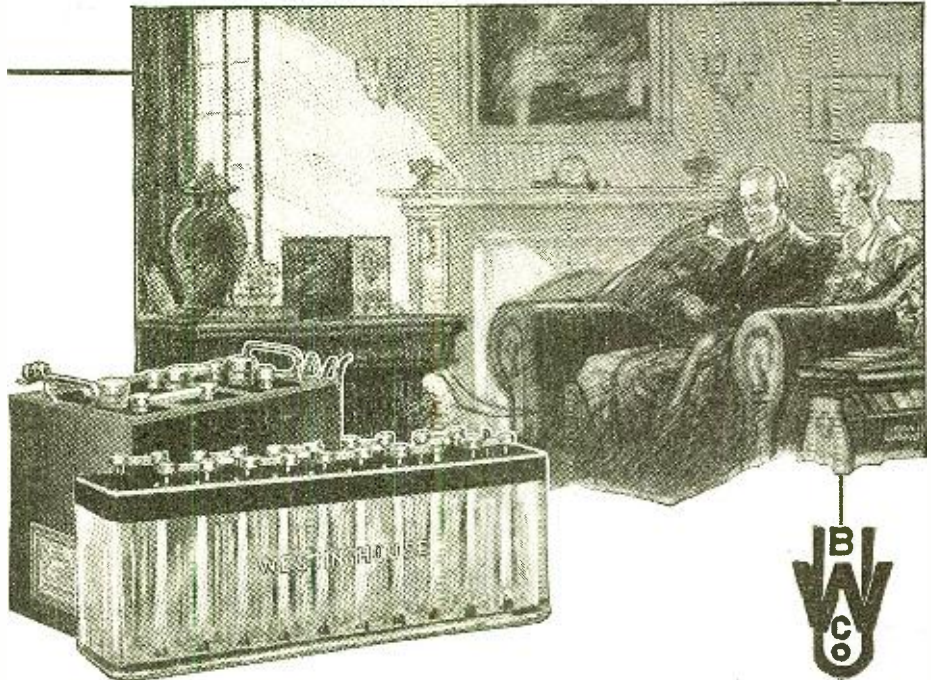

## Enjoy Radio at its best

Dependable, even-powered batteries mean better control—quicker and sharper tuning—more complete and constant mastery of your radio set. Westinghouse Batteries are right in step with the latest advancements in radio receiving. Can be easily and repeatedly recharged. No discouraging results from run-down batteries!

**Westinghouse "A" Batteries** are carefully constructed, full-capacity, slow-discharge, long-life batteries. Made in 4-, 6- and 8-volt sizes with 3, 5, 9 and 13 plates per cell, to meet all filament-battery requirements.

**Westinghouse "B" Batteries.** The Westinghouse 22-MG-2 (22 volts) is a marvel for steady, noiseless, full-powered service. Glass case; visible interior; sealed-in tops. Larger types, too; also 2-volt single cells for "C" batteries.

At radio dealers and Westinghouse Battery Service Stations everywhere. Write for illustrated folder, "Westinghouse Radio Storage Batteries."

WESTINGHOUSE UNION BATTERY CO., Swissvale, Pa.

# WESTINGHOUSE

## RADIO "A," "B" and "C"

### BATTERIES

## Spirola BETTER LOUD SPEAKERS

AT HALF THE USUAL PRICE  
Real Cabinet Type—Not Just a Common  
Horn Built Into a Cabinet  
Beautiful—Compact—A tone comparable  
only to the finest cabinet phonographs

We make a complete line—of the highest class construction throughout, with fine hand-rubbed finishes. All SPIROLAS are sold under moneyback guarantee to equal in volume and far surpass in beauty and tone any other up to twice their price.

SPIROLA DUPLEX—for use with any headset. Improved type with separate tone chamber for each phone, eliminating usual interference between phones. Satin black finish with nickel-plated fittings (Model DB).... **\$3.85**

OAK (DO) or mahogany (DM) finish, bronzed throat and fittings.....\$4.85  
SPIROLA SIMPLEX—for use with Baldwin or other unit. Black (SB), oak (SO) or mahogany (SM) finish, same prices as DUPLEX.

SPIROLA CONCERT—complete with built-in special unit and cord ready to attach in place of phones. Oak (CO) or mahogany (CM) finish, bronzed throat \$12.50  
At Dealers or postpaid, carefully packed (C.O.D. if preferred)

L. H. DONNELL MFG. CO., DEPT. A, BOX 70, ANN ARBOR, MICH.

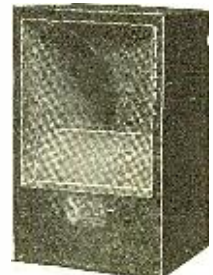

## Compare These Prices

WHY PAY MORE WHEN YOU CAN GET ROCK BOTTOM PRICES FROM US

Just glance over our list and send us your Money Order. Twenty-four hours after receiving your order it is on its way to you.

List Price	Our Price
\$ 5.00	Radiotrons U V-200.....\$ 4.25
6.50	Radiotrons U V-201..... 5.75
16.00	Baldwin Phones type C..... 12.00
7.75	Baldwin Units Loud Speakers..... 6.00
8.00	Federal 2200-Ohm Phones..... 6.00
8.00	Brandes Superior Phones..... 7.00
5.00	Acme Transformers..... 4.25
1.90	Double Jacks..... .60
.70	Single Jacks..... .50
2.50	Bull-Dog Plugs..... 1.25
	Contact Points, per doz..... .15
	Switch Levers 1/2 in. radius..... .25
45.00	Maagnos..... 38.00
1.50	100 ft. standard Aerial Wire..... .50
.50	Aerial Insulators..... .20
1.00	100 ft. stranded Aerial Wire..... .40
75.00	Paragon R A-10 set..... 68.00
25.00	90 ampere guaranteed Storage Battery..... 18.00
1.00	Rheostats..... .75
1.00	Fada Rheostats..... .75
1.00	Vacuum Tube Sockets..... .65
18.50	Honchargers..... 15.50
3.50	B. Batteries volt meters 0-50 V..... 2.75
55.00	Western Electric new style Loud Speakers..... 42.75
.75	Rheostats..... .60
3.00	B. Batteries..... 2.25
2.50	B. Batteries..... 2.00
1.75	B. Batteries..... 1.10
1.50	Dials..... .75
1.00	Dials..... .40
2.75	De Forest Detectors..... 1.50
.75	Sockets..... .60
6.50	Westinghouse W D-11 Tubes operated on 1 dry cell..... 5.98
1.00	Westinghouse W D-11 Sockets..... .65
4.50	Thordarson Transformers..... 3.75
2.00	Potentiometers..... 1.25
1/2	Megohm Grid Leaks..... .60
1/2	Megohm Grid Leaks..... .65
1.00	Grid Leak Holders..... .65
1.00	Double Phone Cords..... .60
.50	Single Phone Cords..... .35
	Duplex Phone Adapters fits Edison, Victor or Columbia..... 1.75
	Genuine Bakelite Panels per sq. in. Spaghettil, per ft..... .09
12.00	Genuine Western Elec. Signal Corp. VT2-Tubes..... 9.00
112.00	Deforest type Honeycomb set, special Mahogany Cabinet..... 65.00
3.00	Racony Electric Light Aerial..... 2.90
35.00	Autolux Loud Speakers..... 18.50
6.50	Turney 3,000 Ohm Phones..... 4.25
4.50	Diamond 2,000 Ohm Phones..... 3.75
5.00	Fischer Variometers..... 3.75
6.00	Fischer Variometers..... 4.75
5.00	Fischer Variocouplers..... 3.75
6.00	Fischer Variocouplers..... 4.75
8.00	Atwater-Kent Variometers..... 7.00
8.00	Atwater-Kent Variocouplers..... 7.00
5.00	Pathe Variometers..... 3.75
14.00	Atwater-Kent Mounted Variocouplers..... 11.75
16.00	Atwater-Kent 2 step amplifier..... 13.75
8.50	Everet Head Phones, 3000 Ohms..... 4.95
1.50	Thordarson Rheostats..... 1.15
	Bus Wire for wiring sets, per ft..... .02

Honeycomb coils all sizes 20% discount. Space being limited we are obliged to omit many items.

WRITE FOR OUR QUOTATIONS.

## Cut Rate Radio Co.

P. O. Box 472 Newark, N. J. Dept. A

### HYGRADE SPECIALS

No. 763 Eveready Variable B. Battery.....	\$1.25
No. 766 Eveready Variable B. Battery.....	2.25
No. 767 Eveready Variable B. Battery.....	4.25
Skinderviken Transmitter Buttons.....	.75
2000-Ohm Murdock No. 56 Head Set.....	4.49
3000-Ohm Murdock No. 56 Head Set.....	4.98
Federal 2200-Ohm Head Set.....	6.50
Diagraph 3000-Ohm Head Set.....	9.30
6 Volt 20 Amp. Marko Storage Batteries.....	12.30
6 Volt 50 Amp. are.....	15.50
6 Volt 80 Amp. are.....	18.50
6 Volt 100 Amp. Guaranteed 2 Years.....	18.50

All orders must include Parcel Post charges.  
HYGRADE ELECTRICAL NOVELTY CO.  
41 West 125th St. New York, N. Y.



**G-W Slider**  
REDUCED TO **15c**  
GEHMAN & WEINERT  
42 Walnut St., Newark, N. J.

afford connecting leads. The wire was kept from unwinding by means of a few drops of sealing wax.

The two wire ends obtained by cutting the center turn are denoted at B and C. These two leads, as well as the two connections to the separate sliders, are the only leads to be taken from the tuning coil.

In order to prevent the sliders from passing the center positions, a small drop of solder was placed on each slider rod at the proper positions.

The apparatus may be mounted on a panel, as I have it, or it may be scattered about the table.

If the panel mounting idea is employed two slots may be cut in the panel to allow adjustment of the sliders. A panel and layout similar to the original specification may be used with good results.

The control of this receiver is very precise, and it is quite as selective as a standard double circuit. In fact, it is even more selective than the usual double circuit receiver. Many combinations of inductance and capacity may be obtained; the value of this is very great as it assists greatly in obtaining maximum results.

If the reader desires to construct a two-slide tuning coil, it would be advisable to use bare wire of No. 20 gauge. The wire may be wound on and the turns separated from each other with cord. The cord may be removed and several coats of shellac applied to retain the wire in position.

The distributed capacity of such a tuner would be quite low and the efficiency quite high. A thin (the thinner the better) bakelite tube will be quite suitable for the winding form.

A two-slide tuner may be purchased for a few dollars and a really efficient set may be made with it.

## New Radio Patents

(Continued from page 1661)

tery, 6, for heating it to incandescence and the grid, 4, is given a definite positive potential with respect to the cathode, 2, by means of a battery, 7. In some cases, the desired results may be obtained by merely connecting the grid, 4, to the positive end of the cathode. The curve, A, of Fig. 2, represents the relation between current and voltage in the usual two-electrode high-vacuum electron-discharge device. Above a certain point the device has a working range over which the current varies substantially as the 3/2 power of the applied voltage while below that point, that is, at low voltages, there is no well-defined relation between current and voltage. Above the working range over which the current varies as the 3/2 power of the applied voltage, a point not shown on the curve will be reached at which all of the electrons emitted from the cathode are useful in carrying current and further increase in voltage will have no effect on the current. Curve-B represents the relation which may be obtained between current and voltage in a device which is arranged in the manner shown in Fig. 1. It will be seen that this curve is substantially a straight line between the limits given. In other words, between these limits, the current varies directly as the applied potential and this relation holds over a wide range between very low voltages and voltages approaching the saturation voltage.

APPARATUS FOR PREVENTING STATIC INTERFERENCE IN RADIOSIGNALLING  
(No. 1,426,133, issued to Roy A. Weagant of New York City, August 15, 1922)

This invention pertains to a receiving apparatus for wireless signals comprising a combination of loop collectors spaced horizontally by an appreci-

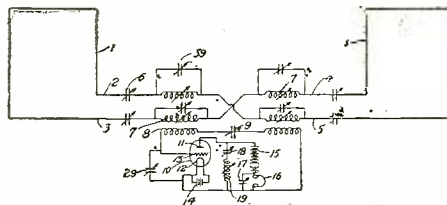

able fraction of a wave length and having their ends so conductively connected that impulses set up simultaneously will oppose each other, and means for adjusting said collectors to the same frequency. It has been found by experiment that atmospheric disturbances act as though propagated

## RHAMSTINE\*

Price \$1.00



WD-11 TUBE SOCKET

Graceful in design, it has the outstanding attractiveness of real individuality. In offering the WD-11 Tube Socket Rhamstine\* has responded with a type that characterizes the high Rhamstine\* Standards. Essentially a heavily plated shell mounted on a condensite-celeron ring—a design which will immediately impress you as being most practical.

The demand for the Rhamstine\* WD-11 Tube Sockets will be great without a doubt.

We urge that you order your stock at once.

Manufactured by

**J. THOS. RHAMSTINE\***

2152 E. Larned St. Detroit, Mich.

\*Maker of Radio Products

**Both Selling Fast Because the Price is Right!**

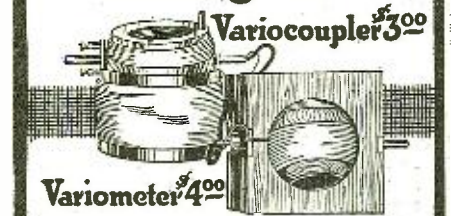

Variometer \$4.00

Variocoupler \$3.00

Set of Three

2 Variometers \$8.00

1 Variocoupler \$3.00

"Chi-Rad"

Special \$10.00

Send Your Order in To-day

OUR NAME PROTECTS YOU

**CHICAGO RADIO APPARATUS CO.**

415 So Dearborn

Chicago.

DON'T

Feel your way

—USE—

**AMPERITE**

Automatic Filament Current Adjuster  
Eliminates Rheostats Saves your Tubes



Manufactured by  
**RADIALL COMPANY**  
97 Warren St.  
New York

\$1.10 with mounting



This official 14K. gold plated label button is now being given free to all new members of the Radio Experimenters' League. See special notice under Wireless heading in Classified Section this issue. Old members who have not yet received their label buttons send at once for one free. Tell your friends to join.

RADIO EXPERIMENTERS' LEAGUE

Run by Amateurs for Amateurs

P. O. Box No. 1 - Newark, N. J.



in a vertical direction only, whereas commercial radio signal waves travel horizontally or have a large horizontal component of motion. Consequently, static disturbances act simultaneously on the parts of a collector system which may be of the same height while commercial radio waves act simultaneously on those portions of a collector or antenna system which lie in a plane at right angles to the line of travel of the waves. Means are here shown whereby the effects of the atmospheric disturbances upon two parts of a collector or antenna system may be caused to neutralize each other, while the effects of the signal waves act cumulatively on the receiving instrument owing largely to the fact that the antenna or collector system comprises portions which are spaced apart along the line joining the receiving instruments with the source of the signal waves.

**METHOD AND MEANS FOR PREVENTING AMPLIFIERS FROM OSCILLATING**

(No. 1,426,733 issued to Raymond A. Heising, East Orange, N. J., August 22, 1922)

This invention relates to thermionic amplifiers or repeaters, and the object of the invention is to provide simple methods and means whereby a thermionic tube or audion used to amplify alternating current of particularly high frequency alternating current, can be kept from oscillating with a period or periods of its own, owing to the capacity coupling between the grid and the plate or other elements of the tube. Fig. 2 represents

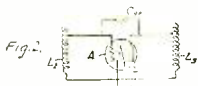

the circuit in simplified form and shows a tube, A, with input inductance, L2, and output inductance, L3, the grid-plate capacity being diagrammatically shown by a connecting capacity, Cgp. The frequency of oscillations set up will depend upon capacity, Cgp, and inductances, L2 and L3. If L3 is made sufficiently large, no oscillations result as the energy fed back to the input will be too small to cause enough amplification of any existing oscillations to cause them to continue.

**Meters For That C.W. Set**

(Continued from page 1652)

higher than 20 amperes, it will be necessary should we desire a volt-meter reading up to 1,000 volts, to make the 110 volt mark correspond to a point rather less than "3 amperes" on the old scale, by increasing the resistance. The resistance can be adjusted, within limits, by pushing one of the wires further into the solution, thus altering the range of the volt-meter. As certain chemical changes will occur if the instrument is in use frequently, it is good policy to check it up against a known voltage from time to time and, if necessary, adjust the wires in the solution until the reading is accurate.

After calibration, the voltmeter scale can be pasted immediately below the milliammeter scale and our redesigned meter mounted on the panel. The connections to the set are best made through a plug and two jacks, as shown in the diagram. When inserted in the closed-circuit jack (A), the instrument will function as a milliammeter and when in the open-circuit jack (B) it will function as a volt-meter.

**The Pacific Coast Plan**

(Continued from page 1653)

hour of the day or night with the exception of the silent half-hour as provided for in Section (1).

Section (5): That the traffic schedule after the hour of 10:00 p. m. daily be maintained for the purpose of long-distance amateur transmitting exclusively and that this schedule remain in effect up to and including the hour of 12:00 midnight, daily.

Since it is generally recognized that only by the earnest and unselfish co-operation of all interests engaged in radio transmission

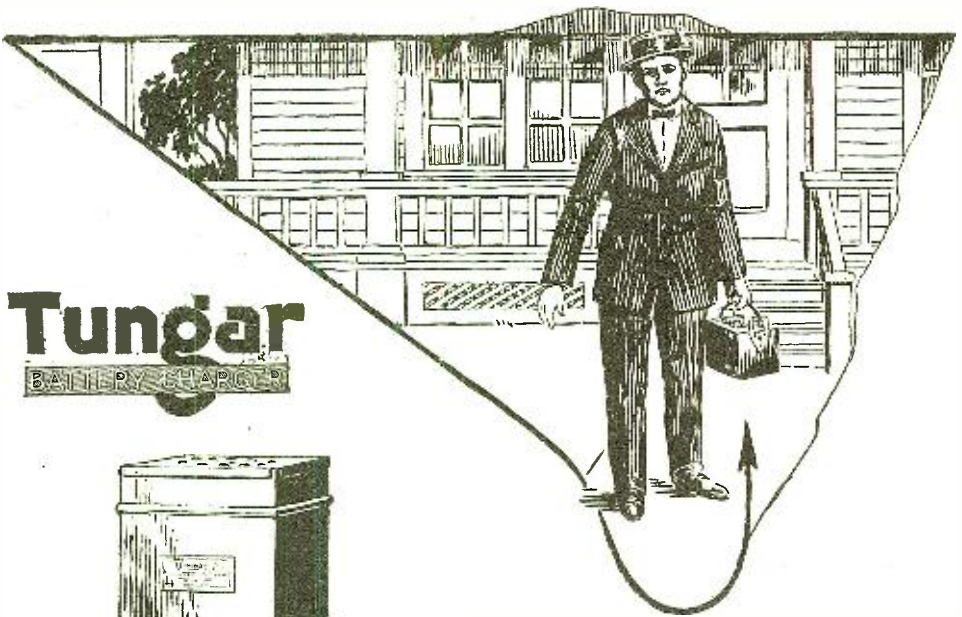

**Tungar**  
BATTERY CHARGER

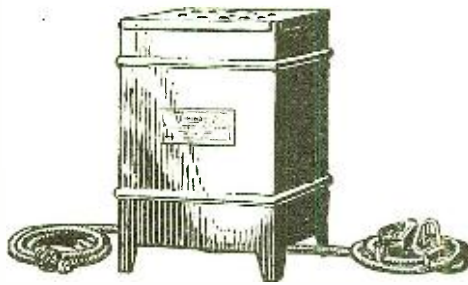

*Tungar Battery Charger—keeps your battery at home. Also, with simple attachment, charges "B" storage batteries.*

**No Need of Doing This**

Is yours a tube set?

Yes? Then you have a storage battery which frequently requires recharging.

Do you carry it to a charging station, wait three or four days, pay from 75 cents to a couple of dollars and then lug it home again? You don't need to.

A Tungar Battery Charger enables you to recharge your storage batteries for either radio or automobile use right at home—easily, quickly and at little expense. It operates from any a-c. lighting circuit.

Any one can operate a Tungar. Once started, it requires no attention; nor is there the slightest danger of injuring the battery.

The initial cost is low; the operating cost is little. Send for our new booklet on Tungar for radio, if your dealer cannot supply you. Address Merchandise Dept., General Electric Company, Bridgeport, Conn.



*This is the way "B" Storage Batteries are charged with Tungar and attachment.*

**General Electric Company**  
General Office Schenectady, N.Y. Sales Offices in all large cities 35A-79C

**Letter That RADIO SET!**



Engrave your Radio Set with ELCO TRANSFERS. Make the most amateurish set look like a professional job. Come in card of 35 different words and characters; everything necessary for the most complete receiving set. Letter panel in Five Minutes. Elco transfers come in gold with black letter; enhance appearance of your set 100%. Are indestructible. Price per Card with Directions (in coin) 35c

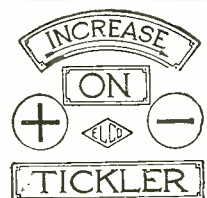

If your Dealer cannot supply you, send us 35c with his name and address.

DEALERS AND MANUFACTURERS Write for samples and discounts. 410 Third Avenue

**Elco Radio Co.**  
Pittsburgh, Pa.



Talk  
Number  
**1**

**SIGNAL**

*Facts from the Factory*

You don't have to fuss and cuss every time you tune up the evening's Radio recreation—or have every other number on your program sound like a selection from *Interference*.

Much of this "interference" is due to apparatus incorrectly, ignorantly, or carelessly manufactured. Do your best on assembling such parts, or manipulating such sets—you never can get satisfaction.

But with SIGNAL equipment—ah, that's different! Our folks have been making wireless apparatus for over thirty years. Men here have grown gray in our service. They take old-time pride in seeing that nothing but the best in materials, workmanship, and finish leaves the SIGNAL plant.

It is made right. It looks right. It works right. If you insist on SIGNAL when you're buying Radio equipment—you will buy Radio satisfaction.

**SIGNAL Electric Mfg. Co.**

Factory and General Offices  
1912 Broadway  
MENOMINEE, MICH.

You'll find our local address in your Telephone Directory (1853A)

Atlanta  
Boston  
Chicago  
Cleveland  
Minneapolis  
Montreal  
New York  
Pittsburgh  
St. Louis  
San Francisco  
Toronto

Information Coupon  
Signal Electric Mfg. Co.  
1912 Broadway,  
Menominee Mich.  
Please send catalog and bulletins giving complete information about SIGNAL Radio equipment to name and address written in margin.

and reception, the maximum benefit or enjoyment can be obtained from the operation of radio apparatus, your personal assistance and active co-operation are requested in carrying out the provisions of the agreement in the same spirit as if it were actually a part of our Laws and Regulations.

Our District already enjoys an enviable record in the radio field for the excellent manner in which it has amicably controlled its private radio communications, and in view of the splendid spirit of helpful co-operation manifested by all interests, we feel assured that it will continue to lead the Nation in that respect.

MAJOR J. F. DILLON,  
Radio Inspector, Sixth District.

**THE MILWAUKEE AMATEURS' RADIO CLUB**

The Milwaukee Amateurs' Radio Club, which was founded in 1917 and became affiliated with the American Radio Relay League, Inc. in 1919, is enjoying an active and successful season. The society meets weekly at 7:45 p. m. on Thursdays in the Trustees' Room of the Milwaukee Public Museum. Meetings have been well attended, and the membership is increasing.

At the annual election of the board of direction seven members were chosen, and the chairmanship given to C. N. Crapo, 9VD, local district superintendent for the A. R. R. L. In addition to several committee chairmen the board appointed the following officers: H. F. Wareing, president; E. T. Howell, 9CVI, vice president; H. G. Fawcett, secretary; E. W. Ruppenthal, 9AYA, treasurer; and L. S. Baird, business manager.

The appointment of I. H. Strassman, 9-AHO, to the post of A. R. R. L. city manager followed a recommendation to this effect by the club. Five candidates had entered the field, but the club did not make its selection until after all the contestants had carefully stated their platform and scheme of city organization. The amateur, his organization, and his relation to the general public have been the topics of many heated controversies on the floor of this club's meeting hall.

Membership appeals alike to "DX" men, experimenters, and novices. There are three grades of membership, the first grade requiring that the member hold a U. S. operator's license. Dues are only fifty cents a month in addition to the two dollars a year for A. R. R. L. membership and QST. Visitors and prospective members are welcome at all meetings. The club stands ready to help the new-comer by teaching him the code and enlarging his acquaintance among radio amateurs.

**PLANS COMPLETE FOR THE SECOND DISTRICT CONVENTION**

An annual affair that is the culmination of all radio for the season is held every year by the Second District Executive Radio Council. This one will be the third of its kind, and everyone who attended last year's Show and Convention can vouch for the success of the affair.

This year the convention will be held at the Hotel Pennsylvania, March 1, 2 and 3. The Roof Garden and adjoining Butterfly Room will contain the exhibits and lecture room. It is planned that any of the Radio Clubs affiliated with the Council are to have booths at the convention, and there will also be some of the historic radio sets on view. There will also be a museum of old time apparatus, such as amateur operators used 10 or 12 years ago.

In order to keep the crowd within bounds and not have a repetition of last year's terrific crush, tickets will be sent to the different Radio Clubs for distribution. The Convention will be opened to

*A good article is always imitated!*

Be sure you receive the  
**FRESHMAN**  
Variable Grid Leak and Micon  
Condenser Combined

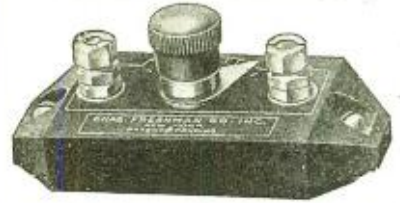

Price only \$1.00  
**3 Points to Remember**

1. It is hermetically sealed in a mould to prevent moisture from affecting the grid resistance.
2. It has an unbroken range from zero to 5 megohms, allowing proper adjustment for maximum efficiency of detector.
3. It contains a tested Micon Condenser of .00025 M. F.

At your dealers—otherwise send purchase price and you will be supplied without further charge.

Manufactured by

**Chas. Freshman Co., Inc.**  
97 Beekman Street, New York City



**RADIO ANTENNA TOWERS**

Simple. Sturdy. Easy to erect. Built of galvanized steel. Will last for years. 100 ft. high or less. Fitted to take pipe mast at top. Immediate shipment. Write TODAY for prices.

Radio Department  
**STOVER MFG. & ENGINE CO.**  
FREEPORT, ILLINOIS



**Equipment Cord Tip Jack**

This R.T.S. Cord Tip Jack leads the way in quality, service and price. Constructed of spring phosphor bronze, highly nickelled. Wiping spring contact insures clean, positive contact at all times. Where others sell from \$1.00 to \$2.50, this R.T.S. Cord Tip Jack Retail at ..... pre paid 50c

Jobbers and Dealers: Send today for new wholesale catalog with scale of prices and discounts to the trade.



**RADIO TESTING STATION**  
Dept. R-3 25 Sturgis St. Binghamton New York

**BELDEN**  
**Manufacturing Company**  
CHICAGO  
Radio Wires, Coils and Parts  
for  
Manufacturers and Dealers

**GREEN SEAL**  
AIR-WAY RADIO Equipment appeals to the discriminating user for its genuine quality at fair prices. Write for Free Air-Way Bulletin of Complete Sets and Standard Parts. Attractive dealer proposition.  
Air-Way Electric Appliance Corporation, Toledo, Ohio.

**MARSHALL CONDENSERS**  
FULLY ASSEMBLED or READY TO BUILD  
NEW HAVEN RADIO CO. Manufacturers, NEW HAVEN, Conn.

WATCH FOR **SUPERAMPLIFIER**  
THE VARIABLE

25 Radio Frequency Circuits Postpaid 75c  
Simultaneous R. F. & Audio Ampl., TUNERS, etc.

**SUPERAMPLIFIER CO.**  
514 Fullerton Ave., Chicago

**CARDBOARD TUBING**

Seamless—Grey	Per Inch or Fraction	Per Ft.
2 1/2, 3 and 3 1/2 in. O. D.	3 1/2 c.	30c
4, 4 1/2 and 4 3/4 in. O. D.	4 c.	35c
5 in. Outside Diameter.	4 1/2 c.	42c
5 1/2 and 6 in. O. D.	5 c.	50c

Postage Extra—Shipping Weight, 1 lb. per ft.  
Dealers Write for Discounts  
**MICHIGAN RADIO CO.**  
2173 Hillger Ave. Detroit, Mich.

licensed amateurs and their friends only. This will enable the exhibitors to show their apparatus in the proper way. There will be 24 booths available, which will be open to bona fide radio manufacturers. Dealers will not exhibit on account of the fact that in the past there has been too much duplication of apparatus.

Don't forget the dates, March 1, 2 and 3, at the Hotel Pennsylvania, New York City!

**RADIO LAW SUIT FIRST OF ITS KIND**

What is reputed to be the first case of its kind in the history of the State of Illinois, and possibly of the United States, is soon to be tried in the Livingston County Circuit Court at Pontiac, Illinois.

The question as to whether or not one may use the air and space in a free and unhampered manner is the basis of the suit.

Edward McWilliams, a radio fan of Dwight, Illinois, has brought suit against Wiley Bergman, also a resident of Dwight, Ill., and asks that Berman be enjoined from interfering with his sending apparatus, the reception of concerts and other broadcasting, being received by McWilliams.

McWilliams charges that Bergman is interested in radio in purely an amateur way and handles no commercial business whatever and that his transmitting so interferes with reception by other stations as to make their receiving sets practically worthless.

He also charges that Bergman confines himself to no regular hours of transmitting and that he frequently interferes with reception by other stations when knowing that he is doing so, and that he refuses to desist, although it has been brought to his attention in a friendly manner.

The bill states that owing to the increased use of radio transmitting stations should be so regulated as to not interfere with other stations, and that it is possible for Bergman to operate his station at times when it will not interfere with others.

McWilliams also asks that the right of himself and the defendant be fully established.

The results of this test case are eagerly looked forward to, as it opens up an entirely new angle to radio transmission and will bring up questions of law that are entirely new and untried.

**A GOOD LOW-POWER TRANSMITTER**

By EVERETT H. GIBBS

There has been much demand of late for a cheap but efficient C.W. transmitter from many men about to venture into the amateur transmitting field.

The following is such a transmitter, requiring only a spark coil, an 8-volt storage battery, a transmitting tube rated at five watts, a rheostat, a .001 mfd. grid condenser

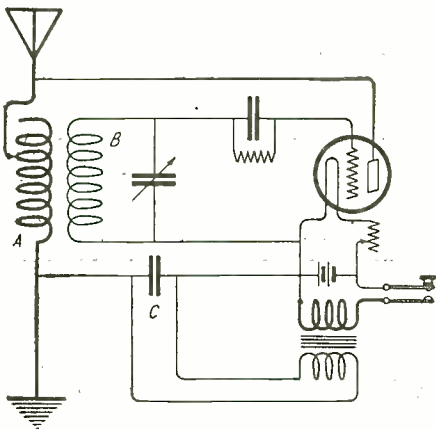

A Simple Low Power C.W. Transmitter Employing An 8-Volt Storage Battery for Both Filament and Plate Supply.

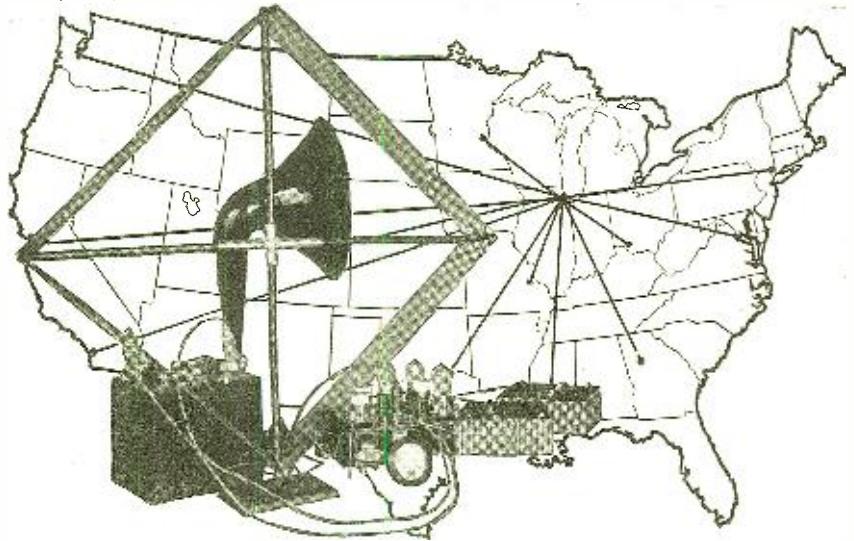

**Four Tubes Now Do the Work of Seven**

Again Erla offers invaluable contribution to radio science. The Quad-Six Super-Radio-Frequency Circuit—an Erla achievement—takes first place among the notable discoveries of the year.

Six stages of amplification—four radio and two audio—are secured with the use of but three amplifying tubes, and a detector, giving the efficiency of the best seven-stage circuits of conventional design.

If your home is within even the utmost range of metropolitan broadcasting stations you can now enjoy the same advantages as those who are close at hand. Moreover, outside antennae are dispensed with, a loop serving satisfactorily, except for the most extreme ranges.

Equally remarkable are the simplicity and ease of tuning, and the perfect modulation and tone character, surpassing the finest phonograph in quality and volume.

Employed exclusively in this circuit are Erla radio frequency transformers. Their unique ability to overcome the high capacitance effects of domestic vacuum tubes, as well as their own reduced capacitance, account largely for the exceptional ability of the Quad-Six in long distance work.

To obtain full information about this latest and most efficient of circuits, ask your dealer for our Special Bulletin No. 14, showing the circuit in detail, with complete directions for installing. Or write us, giving your dealer's name.



Erla radio frequency transformers are unequalled in efficiency, quality and value. List price, \$4.00.



Erla bezels double the attractiveness of any receiving set. Fit 1 1/2" hole in any 1/8" to 1/4" panel. List, 20c.

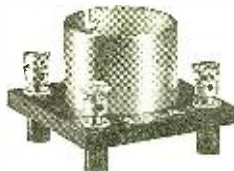

Made with jeweler's precision, the strength, beauty and finish of Erla sockets are unsurpassed. List, \$1.00.

**JOBBERS**—Erla products are at the forefront of radio development, building business in steadily increasing volume. Write for our highly liberal terms and discounts.

Electrical Research Laboratories  
Dept. D 2515 Michigan Ave., Chicago

**ERLA**

**\$25.00 IN CASH PRIZES**

will be given to the four persons sending in the best description and diagrams of our Skinderviken button used in connection with a radio loud talker or radio amplification. Everyone is eligible. You don't have to make a purchase to win a prize. Describe apparatus and hook-ups in detail and state results obtained. Prize-winners to be selected by the judges—Mr. R. A. Lacault, Associate Editor of RADIO NEWS, and Mr. Ivan Konigsberg of the K. Electric Co. Contest closes in New York on April 1st, 1923. The right to publish diagrams and illustrations submitted is reserved by the K. Electric Co. Winners' names will be announced in the July, 1923, issue of this magazine. In case two or more persons submit one of the prize-winning answers, then the same and identical award will be given to each.

**FOUR CASH PRIZES**

- 1st Prize \$10.00
- 2nd Prize 7.50
- 3rd Prize 5.00
- 4th Prize 2.50

Address all communications to

**K. ELECTRIC CO.**

15 PARK ROW NEW YORK CITY



**Skinderviken Transmitter Button, \$1.00**

With Instruction  
Send for Diagrams, Free

# Gould

## Radio "B" Battery



The compact Gould Radio "B" Battery, (patent applied for) is designed to prevent grounds between cells, thus doing away with noise in headset. 24 volts in variable 2-volt steps. Non-slopping hard rubber case. Will not detract from the appearance of the finest set. \$8.50 f.o.b. factory.

### Essential for Clear Reception

Noiseless operation is the goal of every radio enthusiast. Much of the noise attributed to static is actually developed in the "B" batteries. Especially is this true after the batteries have been in use for a period of time. The reason is due to the internal construction of the dry battery and other types of storage batteries not being properly designed to prevent external grounds between cells. Freedom from noise of the Gould "B" battery is due to its internal construction and the external design of the case which makes grounding between cells practically impossible. (Patent applied for). By the use of the Gould "B" Battery not only is noise eliminated, but its constant non-fluctuating voltage throughout the greater part of its discharge results in clearer reception and increased range. Costing but a few cents for recharging, the Gould Radio "B" battery is more economical and will give most satisfactory results.

On sale by Radio Dealers and over 3000 Gould Service Stations.

### GOULD STORAGE BATTERY CO.

30 East 42nd St. New York  
Plant: Depew, N. Y.

# Gould

## Radio "A" Battery



Gould Radio "A" Batteries are used by the various Radio Branches of the U. S. Government. Built for continuous service. Made in sizes from 60 A.H. to 160 A.H. \$17.00 to \$29.00, f.o.b. factory.

## PHANTOM TUNER

\$19.75 will bring one of these marvelously sensitive instruments to your address, prepaid. No aerial, ground, loop or radio frequency used. All parts highest quality Cutler-Hammer, Dubilier, Remler, etc., mounted on genuine Bakelite panel. Complete instructions for wiring furnished. NO SOLDERING necessary. Have music on 15 feet of lamp cord one hour after set arrives. Our Phantom does get over distance and is thoroughly practical with detector only. Wind lamp cord in auto top and tune music while you drive. We've done it often. Send stamp for booklet which tells the Phantom Story.

VESCO. RADIO SHOP, 328 Main St., Vacaville, Calif.



The Radio Tube Set That Made Good in a Night

W.E. Supply & Service Corp. 18 Murray St., N.Y., U.S.A.

(mica), a .0005 mfd. variable condenser, and a glass plate condenser to prevent sparking across the base of the tube. The inductances are wound with bell wire. The circuit diagram is shown in Fig. 1.

The inductance A is 25 turns of No. 18 wire on a tube 5 inches in diameter, and the inductance B, the grid-tickler coil, is 20 turns of No. 18 wire on a tube 4 inches in diameter. The coupling between these coils is not critical; simply place one inside the other.

C is the condenser across the secondary of the spark coil to prevent sparking across the base of the tube.

This circuit was used because it is a constant oscillator and is so easily tuned to the legal 200 meters.

Any size of spark coil may be used, but one of about 900 volts in the secondary is best. If a coil this size is used, two or three tubes may be operated in parallel. With a good antenna and counterpoise at least half an ampere may be radiated, with maybe an ampere under exceptionally good conditions. Using a regular ground, half an ampere is about the maximum.

The range of this set is, of course, dependent on conditions, but up to seventy-five miles have been covered regularly with such an outfit, using a quarter-inch spark coil and with a radiation of .25 ampere at my station. The night range is about five times this distance, at least, under the same conditions.

### DE FOREST COMPANY DENIES TRANSFERRING PATENT OWNERSHIP

Denial of the published statement that the title or the actual ownership of the now famous De Forest Audion Patents have been given to the Radio Corporation is made by the De Forest Radio Telephone & Telegraph Co., in commenting upon the litigation begun by the Radio Corporation of America seeking to prevent the use of the De Forest element vacuum tubes in radio apparatus manufactured by any one other than the De Forest Radio Tel. & Tel. Co. and the Radio Corporation of America.

The statement issued by the De Forest Laboratories of Jersey City is one that brings new light upon the patent litigation which threatens the actual life of the numberless independent manufacturers who are making use of the 3-element De Forest tube in the building of Radio receiving sets. The statement itself reads in full as follows:

"The attention of the De Forest Company is called to a statement published in the metropolitan press in effect that through the ownership of the De Forest Audion patents covering the use of the 3-element vacuum tube, the Radio Corporation of America has entered suit in the Southern District Court of New York against A. H. Grebe & Company and J. H. Bunnell Company, as joint defenders.

"In this published announcement will be found the following statement:

"The first of the two suits instituted against the Grebe and Bunnell companies involves the two De Forest patents, 841,387 and 879,532. The former covers the vacuum tube as a so-called audion amplifier, and the latter covers the well-known "grid" structure of the modern "triode," or three-element vacuum tube. This suit is the more important of the two.

"The two De Forest patents were transferred to the American Telephone and Telegraph Company by Dr. Lee De Forest and the De Forest Company. The title to these patents has been given to the Radio Corporation, together with the right to sue under them for the purpose of this suit and other specific suits.

"This foregoing statement in regard to

## "SUPERLATIVE" AMPLIFICATION



No. 41

You Can Increase Your Range Eliminate Howling and Distortion

Bring Out the Full Clear Tone in Volume

WITH

## JEFFERSON Amplifying Transformers

Furnished in two types either mounted or unmounted. Coils specially wound with No. 40 and No. 44 wire on a core of the finest rolled Silicon steel.

SEND FOR RADIO BULLETIN

Prompt Deliveries

JEFFERSON ELECTRIC MFG. COMPANY  
424 S. Green St., CHICAGO

## USE OUR FACTORY

Manufacturers and dealers who require wireless apparatus or parts can obtain quantity output and guaranteed delivery.

We have over half a million dollars invested in special and automatic machinery. Wire and metal products our specialty. Send sample your product and receive our quotation on making.

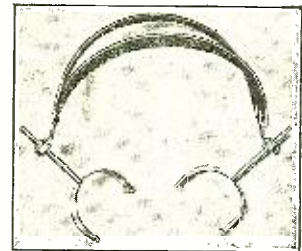

## HEADBANDS

You know this headband. We can make prompt shipment on your order. Get our prices.

## THE AUTOYRE COMPANY

Oakville, Conn.

## RADIO SCHOOL

Positions Guaranteed Graduates

Send for Catalog

MASSACHUSETTS RADIO & TELEGRAPH SCHOOLS Inc.

18 Boylston St. Boston, Mass.  
G. R. ENTWISTLE, Radio Director

## Hear Those Distant Stations!

With the JM-6 Radio Frequency Amplifier. Absolutely dependable for clear, long distance reception

Write now for data and prices

MASSEY RADIO COMPANY

Winchester

Virginia

the ownership of the De Forest Audion Patents is most assuredly a surprising one. The title to these De Forest Patents as well as the actual ownership is vested in the De Forest Radio Telephone and Telegraph Company, by virtue of an assignment from Dr. Lee De Forest. Under the circumstances there is apparently a clear misunderstanding, either on the part of the newspapers publishing this information or upon the part of the Radio Corporation itself.

"In this connection it may be pointed out however, that certain leases and rights have been granted by the De Forest Company to the Western Electric Company, which is the manufacturing company of the American Telephone & Telegraph Company. These leases permit the use of the De Forest three-element vacuum tube in wire telephone communication as well as in the radio field. Rights to manufacture the De Forest Audion and to use it in the field of radio have also been granted by the Western Electric Company to the following additional companies: The General Electric Company, Westinghouse Corporation and the Radio Corporation of America.

"The title and the ownership of the patents, however, still rest with the De Forest Radio Telephone & Telegraph Company and will, in all probability, continue to be held by this Company."

**A NEW WIRELESS!**

I bought a brand new wireless for the kid,  
 And started in to rig it up with vim;  
 I stretched the copper wire two hundred feet.  
 And bought receivers made to listen in!  
 I got a tuner and a finder thing,  
 And read a lot about galena point,  
 I jabbed the needle and I whirled the knob,  
 But couldn't get the outfit into joint!  
 Then twice I got new batteries and worked,  
 And once I caught a faint KDKA,  
 It sounded like an S O S from Mars.  
 And seemed to be a million miles away!  
 I bought a new galena point and monkey-keyed  
 With wires and grounders fastened to a pipe,  
 I got a two-way switch to stop the lightning,  
 But couldn't get the thing to work just right!  
 I got a longer wire stretched for receiving,  
 And painted the arm-piece with parafine;  
 I got some lead and soldered on the ground wire,  
 And licked up wireless dope complete and clean!  
 And every night at eight we worked and listened—  
 The kid would laugh and I would fume and fret.  
 I hate to call myself a wretched quitter,  
 But I haven't got that wireless working yet!  
 LOUISE HOLLINGSWORTH BOWMAN.  
 —From N. Y. Times.

**A Simplified Regenerator**

BY H. L. PETERSON

When "Anxious Inquirer" writes a description of a miscellaneous lot of radio parts and asks "how far can I receive with such a set?" the cold-hearted, matter-of-fact expert answers: "From 50 to 100 miles." Yet maybe in that very issue will appear the claim of some radio "bug" that he has heard Paris or Honolulu on a crystal set.

# WEBSTER RADIO APPARATUS

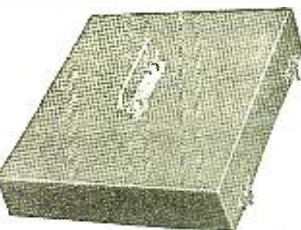
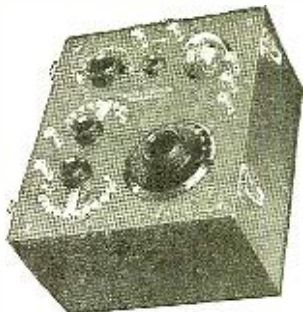

Webster 2A Single Tube Receiving Set. Nickel Trimmings Bakelite Panel and Moulded Knobs and Dials. Walnut finished cabinet. Less Head Set and Tubes \$30.00.

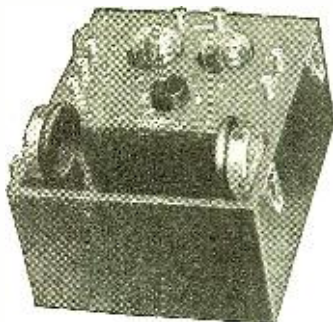

Webster 3B Audio Frequency Amplifier Unit—same fine construction as the 2A Set —Less Head Set and Tubes \$27.50.



Webster Head Sets — carefully matched for tone—2500 ohms resistance—\$7.00.

In Webster Radio Apparatus you get real dollar-for-dollar value. It represents the finest in design and construction.

Take, for instance, the Webster 2A Receiving Set. This set is unusually easy to tune. It is ideal for local broadcasting and for distances of about 50 miles. Under favorable conditions, powerful stations located 150 miles distant and more can be distinctly received.

For use with this set we offer our 3B Audio Frequency Amplifier Unit—a combination with a greatly increased radius of reception.

Prices on Webster Receiving Sets are suitably arranged from \$30.00 to \$119.00. The Webster line of radio parts is high quality in every way. It includes variometers, vario-couplers, transformers, palintrometers—in fact it is complete. If your dealer cannot supply you write for our 24-page catalog and order direct.

**WEBSTER ELECTRIC COMPANY**

RACINE WISCONSIN U.S.A.

Dept. B

Manufacturers of the Webster Magneto.

Over three quarters of a million now in use.

# MEMORIZE IN CODE ONE HOUR

BKUMA YRLSBUG

TRADE MARK REG. U. S. PAT. OFF.

Attentive Beginners Who Use

## DODGE TWO DOLLAR RADIO SHORT CUT SMASH ALL RECORDS

2BXY Mastered Code in ONE and Qualified in 3 Hours.  
 9CCW Memorized Code in TWENTY MINUTES.

For ONE DIME will mail Records made by Beginners in all Districts who easily became Licensed Operators, and to help enlighten and encourage others, have told the story of their Quick Success.

C. K. DODGE

Dept. N, Mamaroneck, N. Y.

\$4.75

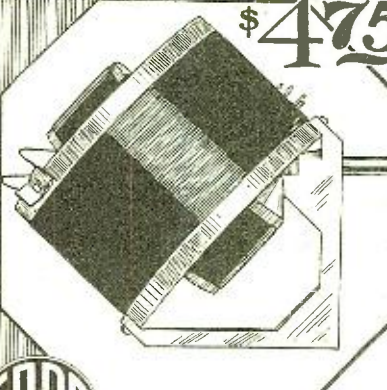

**Vario-Coupler**

The fastest selling vario-coupler on the market. Technically O. K. and the price is right.



**Inductance Switch**

A mighty fine switch. The knob matches Fada Rheostat knob.

40¢



**Series-Parallel Switch**

Changes quickly from circuit to circuit. The handiest switch for experimenters.

55¢



**Power Rheostat**

Will control three or four radio frequency amplifier tubes.

Send 10c for Fada Handbook. Plumb full of radio facts.

\$1.00

**F. A. D. Andrea**  
1581A Jerome Ave., N. Y. C.

FADA  
RADIO PARTS

As I have been having some rather remarkable results with a simplified hook-up, I hasten to assure "Anxious Inquirer" that the range of a single tube set is limited only by the strength of the sending station. I live in Iowa, "the state where the tall corn grows." A circle drawn on a radius of 1,000 miles from my home town takes in every important radio station in the U. S. A. east of the Rocky Mountains and I have heard practically every large broadcasting station within that area, on the simplest and crudest kind of an outfit.

Believing that it will be the best kind of news to every radio fan to know about this outfit, I am telling it where I believe it will reach the largest number.

I graduated myself out of the crystal set class last June. I was a failure at it. Probably on account of my location I never heard a single station sending music with the crystal set all the while I had it. Having had such a poor start in radio, I naturally did not feel like "plunging" on tube set equipment, but proposed to make a set that would "receive over a range of 50 miles," and if it worked all right I would add a "few steps of amplification" later on. This is what I bought:

- 1/2 lb. D.S.C. No. 22 wire... \$ .90
- 23 plate condenser, knocked down ..... 1.85
- Grid leak and condenser... .85
- Rheostat ..... .60
- Tube socket ..... .50
- Phones ..... 5.00
- "B" battery ..... 1.00
- Detector tube ..... 5.00
- "A" battery (second hand). 5.00
- Aerial wire and insulators. 1.00

Total ..... \$21.80

I wound my coil on a "Pettijohn" box as thousands of others have done, 70 turns, a tap every 10 turns. For the panel I used heavy paper board, made from the cover of an old book. The switch points were the bolts off dry batteries.

It perhaps is just as well that we pass over the period immediately following the receipt of these parts. I tried out the whole "57 varieties" of hook-ups. On most of them, all I heard was static and ground hum. I was fast beginning to think that the experts were right and that the ordinary V. T. set would not receive anything over "50 miles." When I ran out of printed hook-ups, I started all over again, and in making some alterations from the well-known "Ultra Audion" circuit, I tried out the circuit here illustrated with such surprising results that I have not been able to equal them in any subsequent experiment, al-

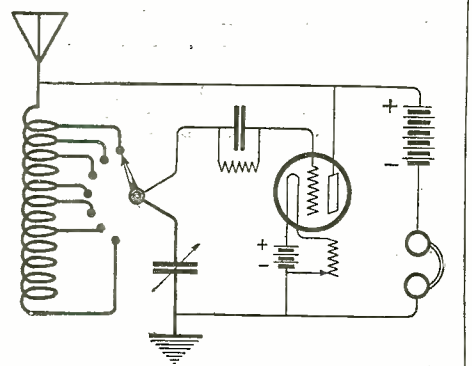

The Ultra-Audion Circuit in Conjunction With An Efficient Tuning System Gives Excellent Results.

though I have tried many of the widely used and generally conceded efficient circuits, including the various feed back and tuned circuit hook-ups.

## USE A C H SHARP TUNER DIALS

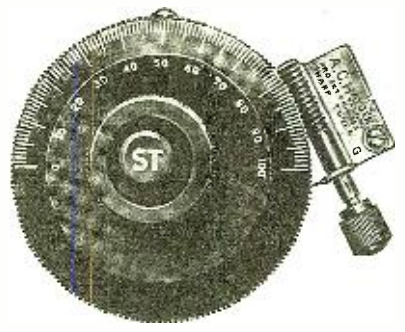

### Your Choice of

Rough tuning with dial or one thousandth of an inch in either direction with the Sharp Tuner Knob. Both controlled by center Knob ST.

Eliminates a vernier condenser. Locks instrument automatically. Dial grounded, reducing body capacity.

### Guarantee

If purchased direct and you find the ACH Dial does not warrant your own personal award of merit, return it and we will refund your money, what better guarantee can we give.

Regular fitting 5/16" hole, 1/4" and 3/16". Bushings, 5c. each extra. 10c. for all.

- Price of ACH 3" Dial Complete..... \$2.50
- With ACH Condenser ..... 4.00
- ACH Condenser without Dial ..... 2.50

Free Plan with mail orders on request.

**A. C. HAYDEN  
RADIO & RESEARCH CO.**  
BROCKTON, MASS., U. S. A.  
Mail Orders sent prepaid in U. S. A.

## CUT PRICES TO CONSUMERS

	Regular List	Our List
UV 200 Tubes.....	\$ 5.00	\$ 4.20
UV 201 Tubes.....	6.50	5.50
WD-11 Tubes.....	6.50	5.50
Baldwin type C Phones.....	16.00	13.00
Macnavoxes.....	45.00	37.00
Murdock Phones, 2000 ohm....	5.00	4.20
Murdock Phones, 3000 ohm....	6.00	4.90
Acme Transformers.....	5.00	1.20
Plugs.....	1.50	.59
Rheostats.....	1.00	.50
Moulded Sockets.....	.75	.45
B Batteries, 22 1/2-volt.....	1.25	.80
Crystal Detectors.....	1.00	.60
Contact Points, per doz.....	.35 per doz.	.15
Switches, tapered knob.....	.35	.20
Honeycomb Coils, all sizes.....	25% discount	
Paragon Ra 10.....	110.00	63.00
Variometers.....	3.50	2.50
Variocouplers.....	1.50	1.10
Dreyfuss Phones.....	8.00	7.00
3-inch Dials.....	.75	.30
Rheostat Dials.....	.50	.23
No. 14 Hard-drawn Aerial Wire, C ft.....	.60 C ft.	.38

We give a discount of 10% on all standard merchandise not listed.

MAIL ORDERS ONLY NO STORE TRADE  
Mail check or money order. No stamps or currency

**RADIO CUT PRICE CO.**  
320 Broadway, New York City

### RADIO DEALERS

In addition to carrying the usual Radio Corporation products, we are now distributors for New York State of the well-known Paragon Radio products, famous throughout the world. Write for latest bulletin and price discounts.

**20th Century Radio Corporation**  
565 Fifth Avenue, New York City

# NOVO

## "B" BATTERIES FOR RADIO

23 1/2 - 45 & 105 VOLT



NOISELESS  
DEPENDABLE  
GUARANTEED

ASK YOUR DEALER

NOVO MANUFACTURING CO.

424-436 W. 33rd St  
NEW YORK

531 SO. DEARBORN ST. CHICAGO.

The first night we used the hook-up we tuned in on a test program of WDY of Roselle Park, N. J. This was the latter part of June, one of the static months. We were astounded, and it was only after we had heard them repeat their announcement two or three times that we could believe we had really heard aright. That was just the beginning, and since then we have heard practically every important broadcasting station from the Atlantic coast to the Rocky Mountains, from the Gulf of Mexico into Canada; often and loudly enough to enjoy the programs.

So far, I have not felt the need of amplification as we get all the volume we want on head phones with the detector alone; in fact, we get more volume than many I know of are getting on two stages of amplification. One night, not long ago, Kansas City, 300 miles away, came in so strong that the sound in the phones could be plainly heard 40' away.

The hook-up is so simple that comment is unnecessary. The lead from the plate to the aerial seems to give an automatic regeneration, bordering at times, it seems to me, on super-regeneration.

While the signals come in, even in the beginning, good and strong, I frequently find, when a station is well tuned in, that by turning on more filament current, the sound in the phones can be greatly increased.

I find that it is very important, for quick tuning, to have vernier control on the condenser and rheostat. The grid circuit, too, should be made as short as possible.

## Form a Radio Club

(Continued from page 1626)

monthly dues, is contributing more toward the failure of his club than anything else. The majority of persons fail to realize this, and it is therefore, not unusual that they should take this stand. It is very important that the officers have the co-operation of the members, for absolutely no progress can be made if co-operation is lacking. A club of any type demands it, whether it be athletic, yacht or any other kind. It is this factor that either makes or breaks an organization, and the co-operation must be of the most active sort. It is also of importance that all clubs become affiliated with some National organization. This cannot be too strenuously urged. National bodies, as well as local clubs, are all doing much good and valuable work which should be encouraged. There are many difficult problems which could be brought to a head much better by all clubs combining and it is such problems as these that the American Radio Relay League, National Amateurs Wireless Association and the Second District Council are attempting to solve.

A club, to be most successful, must be properly organized. The choosing of a suitable and attractive name should not be considered of minor importance, for the name a club bears is very often a reflection on the type it is and the material it is composed of. Do not call it any old thing. An organization is dependent upon a proper constitution and set of by-laws, and both should be as brief as possible and right to the point. Illustrations have often been given where too numerous rules and regulations have been responsible for the wreck of more than one club and complex and unworkable laws are worse than none at all. The Constitution consists of its fundamental laws, while its by-laws are the rules and regulations; therefore, both are of great importance and should not be slighted.

The constitution of a wireless club should bear on such matters as the election and duties of officers, voting power, classes of

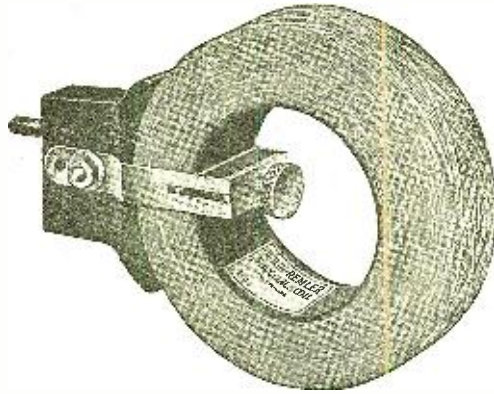

Built on the  
best Engineering  
Principles

Maximum Inductance.  
Minimum Distributed  
Capacity for a given  
number of turns

## The Highly efficient form of winding used in the GIBLIN-REMLER INDUCTANCE COILS is responsible for their SUPERIOR OPERATION

The construction of the most efficient inductance coil ever developed

**D**UE to his untiring efforts to perfect compact inductances, Mr. Thomas P. Giblin has succeeded in developing the Giblin-Remler inductance coil. This coil is undoubtedly the greatest step forward in the radio art since the advent of the vacuum tube.

Built along sound engineering principles, this new coil embodies every feature necessary to obtain MAXIMUM INDUCTANCE, MINIMUM DISTRIBUTED CAPACITY and MINIMUM HIGH FREQUENCY RESISTANCE with a given length of wire and in a minimum of space.

Maximum inductance is obtained by winding the turns parallel and close together in each layer, a feature found only in the Giblin-Remler type of winding. Every turn is wound parallel to the circumference of the coil, thus having a shorter length of wire and less resistance than a turn of equal diameter than any other type of winding.

Write for table of constants and complete information regarding these coils

Send 10c for new 40-page Remler Catalogue containing circuit diagrams for Remler Apparatus and other useful information, including a table of inductance, capacity and wave length.

The Remler Technical Bureau is at your service. Address your problems to Dept. R.

## REMLER RADIO MANUFACTURING COMPANY

Factory and Main Office  
248 First Street, San Francisco, Cal.

Eastern Sales Office  
154 W. Lake Street, Chicago, Ill.



### CARTER "TU-WAY" Plugs and "HOLD-TITE" Jacks

Carter "TU-WAY" Plug takes ONE to FOUR phone sets at the same time. Connects with ANY kind of terminal. Price ..... \$1.50  
NEW CARTER VERNIER CONTROL RHEOSTAT with NICHROME wire and pigtail connection. Price ..... \$1.50  
NEW CARTER AUTOMATIC PLATE CIRCUIT CONTROL RHEOSTAT eliminates change-over switches, filament control jacks, and first and second stage jacks. Price ..... \$2.25

Sold by all good electrical and Radio Jobbers. Write for bulletin on these and other Carter products  
New Control Switches of all types.

CARTER RADIO CO.

209 S. State Street

CHICAGO

WANTED—Back numbers of Radio News, Sept., Oct., Nov. and Dec., 1921, Jan. and Feb., 1922. Experimenter Publishing Co., Inc., 53 Park Place, New York City.

## The Heart of Radio Frequency Is The Transformer

And Your Success in Getting Distance and Distinctness Depends On the Efficiency of Your Transformer

Do not condemn Radio Frequency because you have used poor Transformers. The RT-5 (150 to 300 meters) and the RT-6 (300 to 600 meters) have been tested severely by experts in various parts of the country and are proven without equal in tone quality and distance. They are an absolute necessity to the enthusiast who desires to get the best results from his radio set. With the RT-6 and RT-6A transformers, a loop receiver will operate a loud speaker on distant stations and you can easily receive wonderful programs from Chicago, Kansas City, Dallas, Atlanta, Winnipeg and other distant stations within a two thousand mile radius.

Order by type number, accept no substitute and remember that all Radio Service Laboratories Transformers are individually triple tested and unconditionally guaranteed. For sale at all reliable electrical or Radio Stores or order direct from us.

Send ten cents for new booklet on Radio Frequency with schematic diagrams—a most valuable and helpful publication for the radio amateur and expert.

### RASLA SALES CORPORATION

National Distributor

Dept. A, 10 East 43rd St. New York City.



TRADE MARK  
**Wave Trap**  
PATENT APPLIED FOR

The Missing Link in RADIO



**Stops Interference!**

A wonderful new discovery now allows you to so reduce the interference that spoils your evening concert that it is practically eliminated. The Wave Trap does it. We guarantee it—with your money back if you are not satisfied.

It is installed in a minute by changing only one connection, and is indispensable on any receiving set with any type of antenna. It is mounted on a formica panel in a handsome mahogany finished cabinet 6x5x6 and is a high grade instrument throughout. Our circular tells you how to practically eliminate interference. We will gladly send it to you on request.

**850** Ferbend Electric Co.  
25 E. SOUTH WATER ST.  
**CHICAGO**

Circular on Request.

members, etc. The by-laws should relate to the question of fees and dues, meetings, matters pertaining to the clubhouse, house rules, etc. A club that is to be maintained in a district that boasts a number of transmitting stations, will do well to have a set of traffic rules and also a traffic manager. The Roselle Park, N. J. Radio Club has adopted this scheme and found it to be valuable.

Though some might doubt it, there are many who have no idea as to just what the duties are of the various officers of a radio club, and for those in this class the following data is given. As in all organizations, the Chairman or President presides over all meetings. He also appoints committees, in addition to other duties pertaining to the club. The Vice-president assists the chief executive in the performance of his duties and conducts the sessions in his absence. To the Secretary falls such duties as handling all club correspondence, preparing minutes of the meetings and he should possess a book in which he records the names and addresses of all members. The Treasurer performs the usual duties of a treasurer and has the custody of all funds. Sometimes he is assisted by a Finance Committee. In cases where there is no Publicity Manager, the Secretary assumes this position. There might also be a Technical Adviser. His duties should be to assist the members in solving their technical difficulties, etc. The Roselle Park organization has all these officers, in addition to a Radio Inspector.

How to get together to form a radio club is a question that very often baffles those desirous of taking such action. This is really an easy problem, compared with how to keep them, once they are members. It should not be a difficult problem to get together to organize a club. A good scheme is to give the local newspapers articles, telling about the plan, where the meeting is to be held, etc., and inviting those interested to come out and participate. Here is another scheme which could be inaugurated. Secure the addresses of those who are known to be interested in radio and then send each of them a postcard or letter, informing them of the plan to form a club, etc. The majority of the radio magazines would be glad to co-operate with their amateur friends by inserting articles, notices of meetings, etc.

As was previously stated, the average radio club very often is confronted with the problem of keeping its members, once they are enrolled, and various plans should be adopted to maintain their interest. There is really only one way to keep the members and that is to make the club so active and interesting, that they will not want to resign. A radio club should maintain headquarters of its own and at the earliest opportunity install a good all-wave receiving set, with a two-stage amplifier. If the treasury warrants, a spark or C.W. transmitter should be purchased. A library is a necessity and should also be maintained; this should contain a number of good books on all phases of wireless without which no club is complete. All good wireless magazines should be subscribed for also, for they are necessary. Many fellows will come out just for the purpose of reading the magazines, looking up data, etc., or to try certain experiments which might have been published in some book.

A good club will also incorporate other schemes to hold the interest of its members and a good idea is to install a complete buzzer practice system. This plan can be made a reality at a very little expenditure and is something that every member will appreciate. It is about one of the best steps that could be taken. Many will enroll, if only for the code instruction. It would be a good idea to have code classes at least once a week and appoint a good code man to act as instructor. A workshop should also be maintained if possible, and should

## DEL Felco Radio B BATTERIES



Extra-heavy construction means longer life and absolute dependability under all conditions. Larger cells—easily connected—fully guaranteed.

The Battery with a Reputation Built In!

DISTRIBUTORS WANTED  
Dealers and Jobbers  
write for our proposition.

DEL Felco  
BATTERY CORPORATION  
General Office.....12 Meeting St.  
Factory.....28 Bayley St.  
Pawtucket, R. I., U. S. A.



PUR-A-FORMER  
**\$350**

Here's an audio amplifying transformer without any frills or fancy finishes—just solid honest value. The PUR-A-FORMER is compact and strongly built—amplifies without howl or distortion. Takes minimum space in your set and will produce results equal to many selling at double the price. Winding ratio 4½ to 1.

Buy them at all good dealers.

## DEALERS ONLY—

Write for Harry Alter's RADIO "POCKETBOOK."

A net price catalog of radio supplies published each month. Our wholesale prices hit bottom.

The RADIO "POCKETBOOK" sent free to dealers only. Use your letterhead.

**HARRY ALTER & CO.**

We Sell Wholesale Only

126 N. May St. Chicago

## D E N V E R

COLORADO

9ZAF

REYNOLDS  
RADIO CO.

KLZ

1534 Glenarm St.

LARGE RADIO DISTRIBUTORS

S&C RADIO LIGHTNING PROTECTOR eliminates ground switch and gives complete protection from all High Potential currents.  
SCHWEITZER & CONRAD, Inc.  
4437 Ravenswood Ave. Chicago, Ill.



be fitted out with an assortment of tools, which could be collected by a fund raised especially for this purpose. Then there is bound to be that type of member who will donate this little item and that. A complete electrician's outfit, including an assortment of soldering irons is to be valued. Additional material will suggest itself from time to time. A drawing table and set of instruments would also come in handy. Members could use it for designing sets, coils, plotting resonance curves, etc.

No lively organization should be without a fully equipped station. However, this question is generally governed by the amount of funds available. If possible, a wireless club should possess the following: A spark or C.W. set, a combined long- and short-wave receiver with two-stage amplifier and loud speaker, a wavemeter, a buzzer test system and a complete buzzer practicing outfit. It could also have a good sized blackboard and books containing the call letters of all amateur, commercial and high power stations of the world. Several maps showing the location of said high power and commercial stations and the boundaries of their respective districts, would also come in handy. Radio clubs having transmitting outfits should each note on the map where the inspectors of its respective district would be located and arrange to see him and obtain an official call signal.

### Radio News Laboratories

(Continued from page 1659)

has two wires sealed in the extremities, the ends of which are provided with two oxidized metal balls which serve as a sphere gap. A fibre case filled with a sealing compound protects the glass tube from injury. Being provided with clips at one end, this fibre case fits into the two mountings on the porcelain base. Heavy binding post terminals are provided for connections.

Arrived in excellent packing with instruction sheets enclosed.

AWARDED THE RADIO NEWS LABORATORIES CERTIFICATE OF MERIT NO. 71.

### The New York Radio Show

(Continued from page 1632)

poration, Scholes Radio & Mfg. Corporation, Radio Detector Company, States Radio Corporation, Brilliantone Radio Company, The Radiall Company, Ackerman Bros. Company, Incorporated, Post Electric Company, Boissonault Company, Radio Industries Company, Burgess Battery Company.

### New Radio Legislation Will Soon Be in Effect

(Continued from page 1612)

cluding a representative of the Treasury Department, another from the Shipping Board, and an additional member who is not a Governmental official.

#### FEES FOR LICENSES WILL BE CHARGED

The only cost to the applicant for an operator's license in the past has been the cost of an affidavit; the Government did not charge for examination or permit, and neither did it charge for station licenses. The new bill, as some may have forgotten, provides for a schedule of fees for station



## Responsibility Your First Consideration

**D**URING this formative period in the radio industry, this is the first question a dealer or a retail-buyer of a set or parts should ask—

“Is there a guarantee back of this product; and does the guarantee mean anything?”

The Michigan Radio Corporation consists of

responsible Grand Rapids business men who early sensed the potential possibilities of a Radio business conducted on business principles, and equipped an up-to-date plant for quality radio receiving sets and component parts.

The management is in the hands of seasoned business men, backed by a staff of engineers and technical experts of long experience in Wireless Telegraphy, Electrical and Telephone construction work.

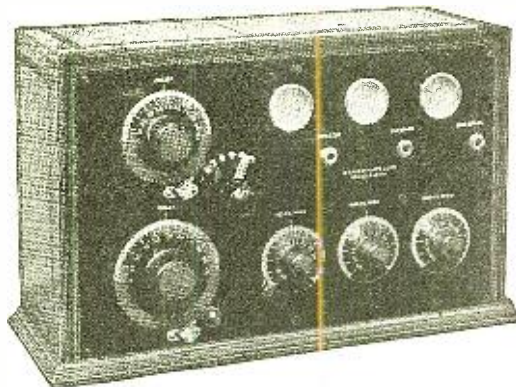

SENIOR SET

### MICHIGAN "SENIOR" AND "JUNIOR" REGENERATIVE RECEIVING SETS

Licensed under Armstrong U. S. Patent No. 1,113,149 and pending letters patent No. 807,388. (For amateur and experimental use only.)

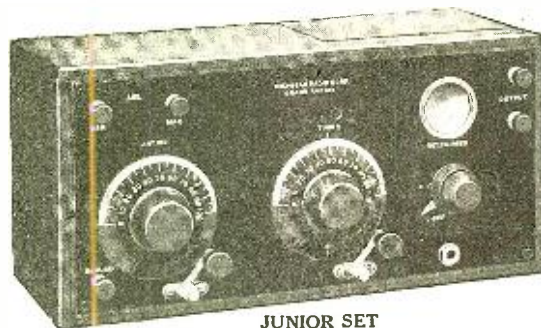

JUNIOR SET

### Long-Distance Wonder-Wonders

Sweep the country from Coast to Coast, giving their owner their pick of the daily and nightly programs broadcasted by the 500 stations in the United States and Canada.

The "Senior" embodies both detection and amplification, and can be used with either headphones or loudspeakers, or both.

The "Junior," a detector unit only, is limited to head-phone reception. It can, however, be hooked

up with the Michigan Amplifier unit, for loudspeaker reception.

"Michigan" Radio Specialties include variometers, variocouplers, variable condensers, all-wave couplers, vernier and plain rheostats, amplifier units, detector units, etc.

Michigan Split-Hair Vernier Dial Control is worthy of special mention. Gives a fine selective tuning hitherto impossible with any other device.

Send for Catalog of Michigan Quality Receivers and Parts

## MICHIGAN RADIO CORPORATION

GRAND RAPIDS, MICHIGAN

## McTIGHE ALKALINE STORAGE "B" BATTERY for RADIO OUTFITS



The McTighe Storage "B" Battery is now furnished in two sizes, the original 22 volt and a new 28 volt battery, having 20 per cent more plate capacity. McTighe Batteries are absolutely noiseless, can be charged from any light socket, and are proof against damage by short circuit, overcharging or standing unused. They are furnished in oblong glass cases which nest neatly, each with its own size.

The McTighe Chemical Rectifier will charge one, two or three "B" Batteries at one time. Our Combination Magnetic Rectifier will charge 6 volt "A" Batteries or "B" Batteries up to 120 volts.

22 Volt Battery	..... \$5.00	Chemical Rectifier	... \$1.50
28 Volt Battery	..... 6.00	Magnetic Rectifier	... 20.00

F. O. B. Irwin, Pa.

**ECONOMIC APPLIANCE CO.**  
IRWIN, PENNA.

Warren  
Radio  
Loop  
Un-  
covered

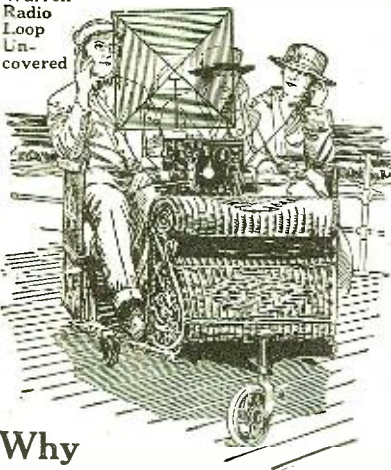

### Why You Should Have A Warren Radio Loop

Makes your set portable; no ground or outside aerial needed.  
Sensitive to direction of wave travel. All interference can be cut out and signals strengthened simply by a turn of the loop.  
Saves space. Sets on top of cabinet, under table, or in any odd space. Inconspicuous.  
All enclosed away from dust, moisture or any possible harm. New design winding. A Warren Radio Loop for every type set.

Type A-737 (300-700 meters) square—non-directional	6 inches	\$10
Type A-726 (175-1000 meters) square—non-directional	6 inches	12
Type B-2537 (300-700 meters) square—directional	18 inches	20
Type BL-2520 (200-18,000 meters) with honeycomb coil, 18 inches square—directional		25

Send for Bulletin T-102  
**V-DE-CO RADIO MFG. CO.**  
ASBURY PARK, N. J.  
Dept. N

### MICON TESTED MICA CONDENSERS



**Assure—**  
Absolute noiselessness  
Clarity of tone  
Accuracy  
Constant fixed capacity

Size	Price	Micon Condensers
.00025	\$0.15	are especially adapted for use with
.0005	.35	Radio - Frequency,
.001	.40	Super - Regenerative
.002	.40	and other circuits,
.0025	.50	where an accurate
.005	.75	fixed condenser is
.006	1.00	required.
.01	1.50	

For protection against damage to the filament and the consequential short life of filaments, Micon Condensers are invaluable.

At your dealers—otherwise send purchase price and the desired Micons will be sent without further charge.

**Chas. Freshman Company, Inc.**  
97 Beekman Street New York City  
*Home of Antenella*

**RADISCO RADIO PRODUCTS**  
THE RADIO DISTRIBUTING COMPANY  
Newark, New Jersey

licenses ranging downward from \$300 for a trans-oceanic station license to \$2.50 for amateur transmitting stations. Operators' licenses will cost from \$2.50 for commercial extra first-class operator's license to \$1 for amateurs, with small additional charges for examinations. These fees, it is planned will aid in the payment of the Government expenses in handling licenses, inspecting stations and giving examinations

### The Passing of NOF as a Broadcasting Station

(Continued from page 1623)

broadcasting of the proceedings of Congress from Arlington.

The concerts of the Marine and Navy Bands, heretofore periodically broadcast from the Anacostia Naval Air Station, have been undoubtedly the popular feature of the services of NOF. Quite naturally, novices and amateurs in the wireless game will inquire, "Is the music from the Marine and Navy Bands to be discontinued?" The United States Navy Department is prepared to assure interested parties that no such procedure is contemplated. In fact, already plans are shaping preparatory to the broadcasting of these concerts from NAA—Arlington or Radio, Virginia—on a wave-length of 710 meters. A microphone is being installed in the band room at the Marine Barracks, near the Washington Navy Yard, and concerts given by these musical aggregations will be relayed by conventional telephone line to Arlington, about seven miles distant.

The preliminary program indicates that on each Monday afternoon at 4:30 o'clock and each Wednesday evening at 8:30 o'clock the Marine Band will play for the benefit of an invisible audience, which Commander S. C. Hooper, head of the Radio Division of the Bureau of Engineering, United States Navy Department, has estimated to be composed of millions of hearers in the aggregate. The Navy Band will give a musical performance each Friday evening at 8:30 o'clock. Music from both of these aggregations, unless present plans are modified, will be transmitted on a wave-length of 710 meters. Also educational material, such as public health lectures, and other informational data originating with the various Government departments, and formerly broadcast from the Anacostia Naval Air Station, will be radiated on the same wave-length.

Since the band of the Marine Corps of the United States Navy Department introduced its concerts on May 31, 1922, about 2,500 voluntary letters have drifted into Washington complimentary to the character of its musical renditions. These testimonials have their sources in sixteen states—from Maine to Florida—with scattering letters of praise from Ontario and Quebec, in Canada. The national anthem, "The Star Spangled Banner," as the concluding rendition of the evening program of the band of the Marine Corps has not only been valued for its melodious strains but in isolated farmstead as well as huddled city apartment such music has increased our patriotism and made for a homogenous people.

The passing of NOF as a pioneer Government broadcasting station, for sentimental reasons alone, is bound to bring a sense of regret to the nightly audience of hearers by radio-telephone receiving sets, an invisible audience which approximated 200,000 at times. The Naval Air Station at Anacostia was the first Government radio laboratory to yield to the demands for a broadcasting service, assigning its powerful transmitting equipment to this purpose. Now, the insist-

### A Dollar Bill

Puts An End To A Peck of Trouble in Battery Testing



Just exchange it for a "CHASLYN" "Sink-on-Swim" Ball Battery Testing Set and be done with burned carpets, rugs and clothing. You "read" it without removing from the acid. So fascinating you are continually checking up your battery and keeping it up to "concert pitch."

Three tiny balls of different colors and densities tell the specific gravity of the acid by the way they sink or swim in the glass barrel. Set also includes DEPTH TESTER and air controlled RUBBER STOPPER for water bottle. Sent complete, prepaid, for a dollar, if your dealer cannot supply you. Circular free.

THE CHASLYN COMPANY  
4315 Kenmore Ave., Dept. 1  
CHICAGO

### ELECTRICITY

Needs YOU Earn \$3500 to \$10000 Yearly

It's a shame for you to work for less than \$100.00 a week when Electricity needs you and will pay you big after you are trained. Ordinary screw driver electricians are plentiful but trained men—Electrical Experts—are scarce.

**Be an Electrical Expert**  
Earn \$70 to \$200 a week. You can do it. I will show you the way. Experience or education unnecessary. Write me today. Let me send you my Big Electrical Book, Proof Lessons, Free Electrical Outline Offer, particulars of my Free Employment and Consulting privileges and my Guarantee Cash Bond—all Free and without obligation on your part.

**L. L. COOKE,**  
Chief Engineer  
Chicago Engineering Works  
Dept. 663  
2150 Lawrence Ave.  
Chicago

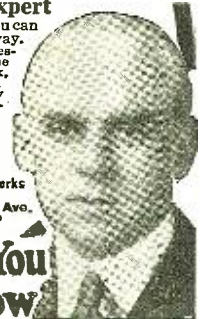

Let Me Train You At Home Now

### Cardboard TUBES FOR Paper WIRELESS

2 1/2, 3, 3 1/4, 3 1/2, 3 3/4 in. O. D.	Per foot	30c
4, 4 1/4, 4 1/2, 4 3/4 in. O. D.	" "	35c
5 and 5 1/2 in. Outside Diameter	" "	40c
6 in. Outside Diameter	" "	50c

Postage Extra, Shipping Wt. 1 lb. per foot  
Dealers, write for special price list

**BAEHM PAPER CO., INC.**  
219 FULTON STREET, NEW YORK

### ONLY \$10 DOWN \$8 MONTH

10 acre summer home, and poultry farm, 2-room house, 100 chickens, overlooking 2 fine lakes, near Shelby and Hart, Mich., country seat. Surrounded by splendid farms and orchards. Only \$695.

**TOPPING & CO.**  
811 Reaper Block  
Chicago, Ill.

### "Use Copper"

In Bulletin No. 32, the U. S. Bureau of Standards says: For all wiring—antennae, grounds, etc.—use Copper.

**COPPER & BRASS**  
RESEARCH ASSOCIATION

23 Broadway - New York

ent demands for renewed efforts in research studies affecting the problems of wireless installation on board air craft make it expedient for a return to the fulfillment of the primary object of its existence. NAA, Arlington, with an elaborate antenna system of a half dozen aerials, capable of operation simultaneously, has the capacity for handling a vast amount of traffic.

**G. E. COMPANY HAS CARRIER CURRENT PHONE**

Officials of the General Electric Company have just announced the successful conclusion of their carrier current experiments in telephone communication, which appear to be something like the wired-wireless system.

According to an announcement the G. E. engineers have communicated over a 70,000 volt transmission line for a distance of 40 miles, using apparatus similar to a radio outfit. For power companies, it is said to have many advantages over ordinary land telephone lines for communication purposes. Carrier-current it is claimed, insures greater permanency and privacy, eliminates static interference and fading, requiring no radio operator.

**A Wireless Selective Call**

*(Continued from page 1613)*

comprises six different times of call and is destined for a given wired-wireless telephone plant. The number of stations to be selected is fairly considerable and depends upon the combinations of fundamental times, numbering, as a rule, ten.

The Call Receiver is shown in Fig. 2 and is actuated by a relay, viz., a contact galvanometer which, being inserted in the anode circuit of a vacuum tube receiver, is so designed as only to make contact as long as there are waves impinging on the call receiver, after which the contact is broken automatically. As a call signal is sent out, all call receivers will be struck by waves, but while the contact galvanometers of all stations make a deflection and all call receivers are actuated, only those of the stations actually required will respond to the call, i.e., the call will only be sounded there until the receiver is lifted. All other stations will remain silent an "engaged" signal appearing at each during the time of a conversation, so that these stations for the time being are forbidden to call up or communicate, lest the conversation be interfered with.

The clockwork disengaged at each receiving station during the time of selection carries along by magnetic friction a selective disc, though only that of the station actually called up operates through a relay, the call signal. After completing a selection or concluding a conversation, all call receivers will return automatically to their initial positions.

The Kellog switch provided in connection with the call receiver has been designed especially for wired-wireless telephony, where the new selective call has already been used successfully.

The apparatus above described is absolutely reliable in operation and affords a means of selecting any corresponding station in radio-telephony as simply as in the case of wired telephony.

**Correspondence From Readers**

*(Continued from page 1657)*

from my ears—here was hope—the sound ceased. I held my hands over my ears—No sound—but the thumping of my over-excited heart.

I replaced the head set and the sound continued, still at about half volume, so I con-

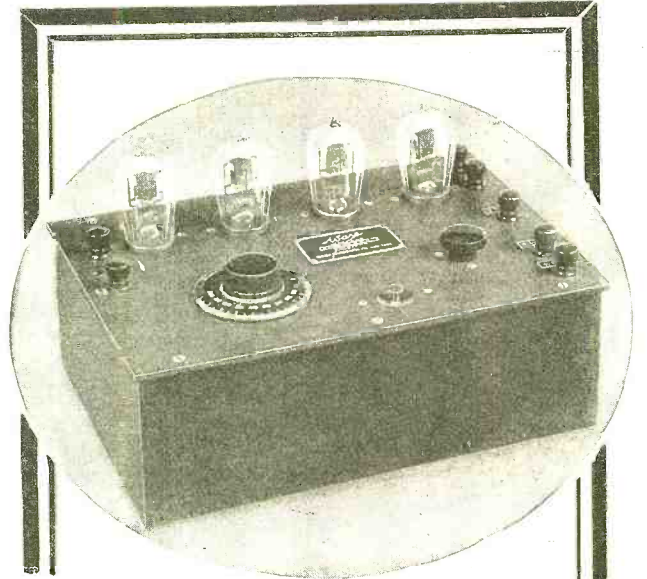

**Up to 3,000 Miles!**

**This IS the Most Sensitive Receiving Set on the Market and Only**

**\$110.00 without tubes, etc.**

**Heard on Small Loop**

**This 3-Step Radio-Frequency Amplifier-Detector Set WILL:**

Operate in any location—steel buildings included.

Reproduce with a tone quality almost unbelievable and positively solve the problem of "static" and other interferences.

Its operation requires no technical knowledge whatsoever.

*Send for Descriptive Booklet  
Dealers Write for Proposition*

*Ware*  
**TYPE AD2**

**R-F AMPLIFIER-DETECTOR  
RECEIVER**

**Ware Radio Corp'n**

**160-162 Duane Street  
New York City, N. Y.**

**Latest Loop Out**

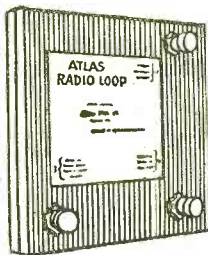

*For Regenerative Sets.  
Can reach Denver, Newark, New Orleans from Chicago,*

or any station your regenerative set can with outside antenna. No changing of set. Have a Portable outfit. 5 days' trial or money refunded. Mailed on receipt of check, money order or sent Parcel Post collect.

6 1/2 inches square, Price \$10.00

**Atlas Radio Co.**

Box 26

Wilmette, Ill.

**THE GOODMAN**



**PATENT PENDING**

**The Niftiest Short Wave Tuner on the Market. Only \$6 & PP on 1 lb. Send for pamphlet**

**L. W. GOODMAN  
DREXEL HILL, PA.**

Doctor \_\_\_\_\_, Norristown, Pa., writes:—Listening in recently with my GOODMAN, heard a voice "We are now 90 miles out from San Francisco." Then DENVER came in and sunk the ship.

# PROFESSIONAL Quality at a Rock Bottom Price

NOW <sup>Was \$10.00</sup> **\$7.65**



3000 Ohms

## TRIMM HEADSETS

The same high quality demanded by expert radio operators is found in the Trimm Head Set at a price any amateur can afford—the lowest price for which a strictly high grade headset can be made and sold.

TRIMM Professional phones are guaranteed equal to other headsets selling for \$10.00 to \$15.00. Positively guaranteed for one year against any defect.

Accurately matched. Perfect reproduction and articulation at any range. Designed and built by highly skilled experts of long experience.

One-piece magnet, formed (not punched), guarantees uniform tempering and magnetizing. Cases and caps made entirely of high grade Phenol compound, free from sulphur and corrosive gases; odorless and warp-proof. New type head band insures perfect comfort.

**Free Trial** If you do not find the TRIMM Professional superior to any \$10.00 headset return it and your money will be refunded.

**DEALERS:** Our wholesale and retail distributors are fully protected. Write for quantity discounts and full particulars. We ship your first order on approval.

**TRIMM RADIO MFG. CO.**

DEPT. 36 24-30 S. CLINTON ST., CHICAGO

## WELSH PEANUT TUBE

W. T. 501

"The Tube That Cannot Squeal"

Sold for experimental use as a detector only.

Filament Voltage 4.6  
Plate Voltage 16-22½

List Price

**\$2.00**  
at your dealer or  
by mail postpaid.

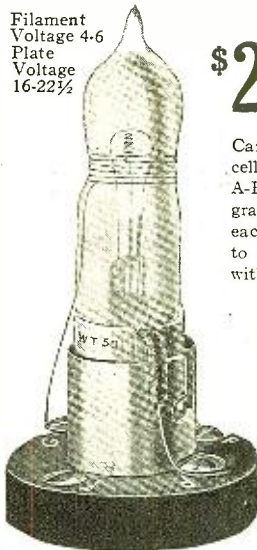

Can be used on 3 dry cells or regular 6-volt A-Battery. Wiring diagram packed with each tube showing how to use the W. T. 501 with any crystal set.

Nickle-plated socket, moulded base, double spring contacts, 40c. extra. Adaptor for standard V. T. Socket, 75c. extra.

Actual size 2½ inches without base. Jobbers and dealers wire for merchandising plan. Packed

10 in a carton, 10 cartons per case. Orders filled in rotation. Please do not ask us to open an account to ship sample tubes. Samples shipped only at list price which will be credited towards your first stock order.

**RADIO RESEARCH GUILD**  
9-15 Clinton Street Newark, N. J.

### The Newest in Radio

The Missing Link—Since 'Phone Broadcasting started a compact up to the minute simple broadcasting time schedule, showing the hour and minute of the many Larger Broadcasting Stations, broadcasting their programs, markets, weather, news, sport, concerts, etc. Just off the press. If your dealer hasn't it, write direct. 30 cents per copy.  
**THE HANDY RADIO CO.,** Moravia, Iowa.

cluded that my theory about having "Radio-bugitis" or whatever term the Medicos apply to this particular malady, was all shot to pieces.

Well, as long as I had my health and sanity, I made up my mind I was going to stick to that noise as long as it lasted and try and formulate some explanation of the phenomenon. Here I was—listening to this buzzing sound through a pair of phones disconnected from the set—said set being disconnected from all batteries, and to make isolation complete, I disconnected the aerial lead, and decreased the sound to about quarter volume. The next step was to disconnect the ground lead but this had no further effect.

I now noticed my phone cord was lying parallel with the aerial wire, so I placed the cord at right angles with the wire and the sound became very much weaker. This cleared up one point at least, I was receiving this queer sound by induction from the aerial lead and not from the set or any hallucination of my own.

I connected the aerial lead directly to the ground lead and laid the phone cord parallel to it. The sound was fully as loud as when connected to the set, and the sound made the phones very uncomfortable.

Now comes the most mysterious and unbelievable part of all. Up to this time the sound had been just one long continuous buzz, never varying the note or missing a beat. I started to coil the phone cord around the aerial wire to see what effect that would have, when my hand accidentally touched one of the terminals on the phone plug. The note took a jump—skyward—in fact it went so high it nearly reached the sphere of inaudibility, and then when contact with my hand was broken, it slowly descended to the original note.

I now struck the phone terminal several quick taps—the note jumped about two octaves at a time and then descended to the original note as before. I was thinking up some new stunts to try on it when it stopped—dead—gone forever—and here I am in a quandry.

I have told my tale to several of my friends who are considerably wiser in things concerning radio than myself, and about all I get is a sympathetic smile or some remark about a generator hum, or hetero-dyning, but this does not explain how I could hear this sound without the use of a rectifier or why tuning or amplification had absolutely no effect on it.

Static also seems to be out of the question, because of the sudden appearance of the sound, and also its uniformity. The only explanation I can think of which in any way seems to fit the case is that some wise inventor is trying to dope out a scheme whereby pre-rectified waves are sent out and all that is necessary to receive these signals is to stand on a fire hydrant wearing a pair of copper soled shoes and a set of phones, with an umbrella raised over your head. If this is the scheme it is as yet far from perfection, because of the strange effect body capacity has on the pitch. For instance, a man weighing 250 pounds listening to a bass solo would swear up and down he heard a XXX soprano while a 100-pound man would be listening to a tenor.

Well, this is as far as I go, in fact I am way over my head now, and I sincerely hope some wise scientist will hear my S. O. S. and come to my rescue.

**M. C. MACNAUGHTON,**  
Jersey City, N. J.

### RADIO FOR THE NEAR-DEAF

Editor, RADIO NEWS:

The writer is particularly hard of hearing and if I attend Church, concerts, etc., can-

## BUILD YOUR OWN RADIO

### The Cost of a Radio is Coming Down!

Why pay the patent royalty on the regenerative license and the profits of manufacturers, jobbers and dealers when you can BUILD YOUR OWN radio set at a low cost? We furnish everything needed so that you can quickly install in your home a

VACUUM TUBE RECEIVING SET FOR **\$38.00** Prepaid

Comes to you complete with mahogany cabinet and Formica panel. No extras to buy and no storage battery to recharge. The \$38.00 covers the cost of everything including one W. D. 11 TUBE and one dry cell battery.

We furnish complete instructions, and give you FREE the LEFAX RADIO HANDBOOK which sells for \$3.50.

Order now sending us cash, money order, check or draft and we will immediately forward set with complete instructions. If you are not satisfied your money will be returned immediately.

**WAVELAND RADIO COMPANY**

Incorporated

1348 North Clark Street, Chicago, Illinois.

## FREE Radio Catalog



Our big stock of standard makes of radio sets, parts and supplies, fully illustrated. **PLAY safe**—buy standard equipment from a reliable house. We ship from stock. Send \$6.50 for genuine Westinghouse WD-11 "peanut" tube—no storage battery needed. 60 cents extra for signal socket. \$1.00 for Bradley Adapter. Wonderful results.

**JULIUS ANDRAE & SONS CO.**  
In business since 1860  
117 Michigan Street, Milwaukee, Wis.

## BRASS

Rods in round and square. Machine screws, any size. Tubing and sheet. Nuts. Small drills and taps. Knobs and dials.

**ANGIERS, U. S. A.**  
**STREATOR, ILL. BRUCE ST. PLANT**

### Genuine GANAERITE Crystals

Individually Tone Tested. Most Sensitive Mineral Rectifier Developed Mounted Crystals, Postpaid, 50c. Trade Discounts to Dealers and Clubs. Now Delivering Promptly on Large Orders.

**THE HARRIS LABORATORY**  
26 Cortlandt Street New York City

## \$48 a Week

Write quick for new proposition. You can earn \$8.00 a day in spare time and get fine new Buick touring car. Be the representative for Comer All-Weather Raincoats. No experience required. Sample outfit free. Write now. **Comer Mfg. Co., Dept. BS-81, Dayton, O.**



### Radio Headsets

3000 Ohms Supersensitive Guaranteed One Year

Price only \$3.98, plus 20c postage, total \$4.18. Cannot be matched at double the price.

Dealer's wire for sample

**ERNEST ELECTRIC CO.**  
4847 Easton Ave., St. Louis, Mo.

not hear what is said nor can I hear the music perfectly. I have a radio set and it gives me the greatest entertainment that I have had in years as I can hear everything perfectly.

The phones in direct contact with my ears bring the sound to me loud enough for me to hear every word that reaches me. Moreover I find that it is improving my hearing as the exercise to my auditory nerves is extremely beneficial.

I am writing you this because possibly some of your readers may be the more interested in radio if they know that it gives such great pleasure to those who lose so much because of defective hearing.

I do not recall seeing this mentioned in any of the magazines and it is a matter that should be prominently brought out because if any should have radio it is those who cannot hear well. It will give them the greatest enjoyment imaginable.

C. T. CANNON,  
Springwater, N. Y.

**AN OPERATOR'S APPRECIATION OF THE SEA-GOING OP'R DEPT.**

Editor, RADIO NEWS:

Allow me to congratulate you on this new division of your magazine. It has profound possibilities, and should become the gathering place for discussion of problems confronting the Operator at sea. Here, I hope, will be the opportunity earnestly looked forward to, and much despaired of ever finding, for the operators to express themselves. The Department, I am quite sure, is going to mean a greater respect of the Ops for your magazine.

J. E. HARA, Conneaut, Ohio.

**A GOOD SUGGESTION**

Editor, RADIO NEWS:

Broadcasting has been under discussion for some time and much has been said pro and con, but I have something to say which I think is of paramount importance.

The Radio Corporation of America was the pioneer of broadcasting radio concerts and has not only kept up the fine quality of these concerts but has improved upon them from time to time, giving the radio fans the best quality of talent procurable. Without this broadcasting there would, practically, be no market for radio parts and, in my opinion, that each and every manufacturer of radio parts, whether it be a loud speaker, a complete set, a hundred feet of antenna wire or any of the other numerous parts that go into the making of a complete set, should be willing to contribute a certain portion of their net profits towards the maintenance of such a station. Each and every manufacturer of radio parts is indebted to the broadcasting stations. Without them, the manufacturer might just as well put the key in the door and hang up a sign *To Let*. Why should a corporation, such as the Radio Corporation of America, which is spending millions of dollars to make radio a permanent, sound and healthy institution which in time is destined to become one of the greatest industries of the world, or, in fact, any other organizations that are maintaining broadcasting stations throughout the United States, have to bear the entire expense of maintaining these stations?

A certain percentage of the net profits of all the manufacturers, in my opinion, should be set aside to be paid over to the proper organizations conducting broadcasting stations throughout the United States, and that all necessary broadcasting of concerts, lectures, etc., should be abandoned. There is no necessity of having numerous broadcasting stations in one vicinity, for it only causes interference which the average radio fan cannot tune out.

Proper broadcasting is the only thing that can make radio a real success, and I say again that each and every manufacturer



Characterize *MASTER* Receivers

**Quality Reception Selectivity**

With a *MASTER* Receiver and an ordinary aerial such as any amateur might use *MASTER* Receivers have "brought in" concerts from cities 2,000 miles away.

Simplicity of construction and ease of operation result in highly efficient selectivity—a feature of paramount importance. *MASTER* Radio Receivers are of the highest quality because made of finest available materials by skilled workmen. *MASTER* Receivers afford perfect reception of voice, music and signals on all wave lengths.

**Jobbers and Dealers!**

Write us for details of attractive proposition

**MASTER Receivers** are assembled from parts made in our own plant. Write for Illustrated Booklets 101-102-103

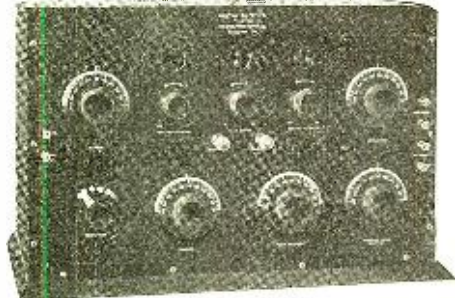

**Union Construction Company**

Manufacturers of

*Master Radio Products*

OAKLAND

CALIFORNIA

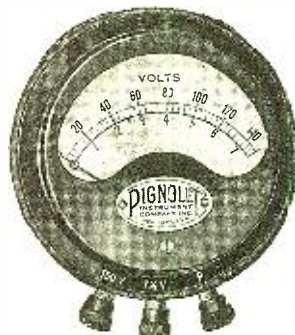

**Pignolet RADIO VOLT-METER**

One Instrument Makes All Tests

Write for booklet with suggestions for testing and adjusting Radio Sets.

**Pignolet Instrument Co., Inc.**  
116 Liberty Street, New York, N. Y.

*The Newest Book on the Newest Subject*  
**INCREASING RADIO EFFICIENCY**  
Through  
**SUPER-REGENERATION**

A direct, simple explanation of the newest radio invention; its methods, circuits and operation. Complete and thoroughly practical. First article of this kind published

**\$1.00**

At Bookstores, Radio Stores or by Mail  
**RADIO CONSULTATION BUREAU**  
Plymouth, Mass.

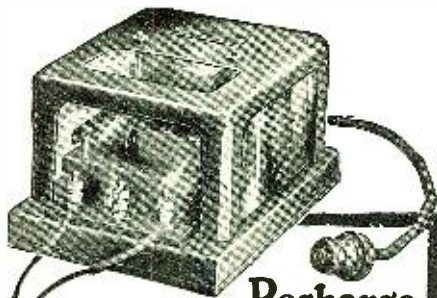

## Recharge Your Battery at Home

Charges Both A and B Radio Batteries

Don't be without the use of your Radio Receiving Set while your battery is being charged. Get a Valley Charger and charge your battery right at home.

Attach the Charger to your home lamp socket—attach the clips to the battery terminals and you will get a quick, tapering charge which just exactly charges your battery, but cannot overcharge or harm it in any way.

Will charge the A 6 volt battery at a 5 ampere rate, and the B 22½ volt battery at the required ½ ampere rate. 46 volt B batteries may be connected in parallel so that they can also be charged. **SATISFACTION GUARANTEED.** If your local distributor cannot supply you, write direct to

**VALLEY ELECTRIC COMPANY,**

Department R, ST. LOUIS, MO.

----- Mail the Coupon -----

Valley Electric Co., Dept. R, St. Louis, Mo.

Gentlemen: I am enclosing money order (or check) for \$18.00, for which send me a Valley Battery Charger with five-panel glass display case and indicator. If not satisfactory, I will return it and get my money.

Name \_\_\_\_\_

Address \_\_\_\_\_

**\$18.00**  
F.O.B. St. Louis

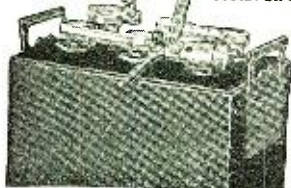

High Efficiency

## HEAD SETS

Army and Navy Type:  
2500 ohms, per pair ..... \$10.00  
3200 ohms, per pair ..... 12.00

Swedish-American Type:  
2200 ohms, per pair ..... 8.00

Victor Type:  
Single coil, double magnet ..... 6.00

Jacks, Plugs, Microphones and other Radio Parts  
Ask for our Liberal Trade Prices

*American Electric*

COMPANY

CHICAGO - U. S. A.

who is now conducting a profitable business owes every cent of profit he is making to broadcasting. We are willing, ourselves, to set aside a certain portion of our profits for the purpose above mentioned. We feel that all other manufacturers will be in accord when they give it due consideration.

DURVEA BENSEL,  
Bel-Canto Corporation.

### BETTER BROADCAST SERVICE

Editor, RADIO NEWS:

December number of RADIO NEWS that and after reading the editorial I have decided to write you, as your ideas are all right so far as they go but they do not go far enough. Take a map of North America and put your pencil where Idaho and Washington join Canada, and you will see where I am. I get Los Angeles, Frisco, Portland, Seattle, Calgary, Canada, Havre, Mont., Denver, and after holding a station for a few minutes have to hunt up another on account of the code which comes in from 200 to 600 meters. You people back there who sit on top of the broadcasting towers little realize what we poor devils who are existing hundreds of miles from nowhere are up against. All broadcasters stick on 360 meters and I have had three stations coming in at once. I think one of three things will have to be done, i. e., suppression of amateurs, weed out high powered junk phonograph record broadcasters, or move up between two and three thousand meters. You ask "why did Radio fall down?" to which I will give you my version: First, people soon get tired of paying from \$200 to \$500 for sets of instruments to establish a station and then get only worthless junk. Second, people don't like to pay \$500 for a set to hear phonograph records; they can hear them for less. Third, people will buy good sets as soon as they can get service out of them and they can't get service out of a set as long as they are run out of every station in from 5 to 15 minutes by some D-d ham with a million watt set butting in to know if his pal is the next county is going fishing tomorrow. Now let us reason a little together; in primitive conditions man ran for his breakfast, later on he increased his speed by using horses, as witness the plains Indians. Still later when his breakfast ran faster he increased his speed with the use of autos, and why are people everywhere buying autos today? Because they want them? Not at all, but because they have got to have them to catch the things which go to make for life. Now when broadcasters give service and people can't live without it, they can and will buy vacuum tube sets. Service is being given by KHJ, The Times, Los Angeles, Cal.

A. S. ALBERT, Ione, Wash.

### THAT'S A NEW ONE ON US

Editor RADIO NEWS:

I am enclosing a clipping taken from the "Montreal Standard" of Nov. 18th, 1922, probably the Hon. lady needs a little education in radio, as I have had gulls perched on the masthead when I have been transmitting and I have never seen one killed yet. London, Nov. 18.—Lady Strachte has started a newspaper campaign against wireless telephony, asserting that it is very destructive to bird life.

"Many birds that have happened to get into a direct line from broadcasting stations have been picked up lifeless," she says, and she urges that broadcasting should be reserved "for the high seas and not for the amusement of crowds."

Allow me to congratulate you on the inclusion in your magazine of a Sea Going Ops. page, I am sure it will be of great interest to all seafaring ops.

I also notice quite a lot of letters in your pages about interference from spark sta-

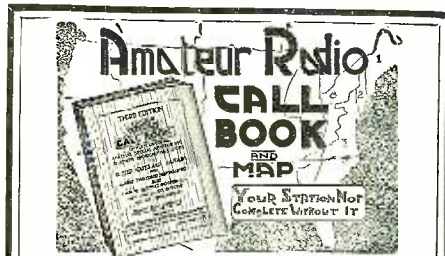

The Book for Radio Fans  
The New Edition of the AMATEUR RADIO CALL BOOK is the most complete directory of amateur stations published to date—listing Amateur, Special Amateur and Telephone Broadcasting Stations of the United States and Canada, also describes the Construction and Operation of a Honeycomb Coil Set, Detector and Two Stage Amplifier.

### THE RADIO MAP

Of the United States and Canada, size 2 x 3 feet, supplies an indispensable requisite of every radio station. The nine radio districts, broadcasting stations, standard time areas, etc., etc., are clearly indicated.

### Record Your DX Work

By pasting the map on heavy card board and using colored stick pins you can easily record your distant radio work.

At Your Dealer or Send Direct

PRICE book and map complete (Do Not Send Stamps) **\$1.00**

Dealers Write for Proposition

**RADIO DIRECTORY and PUBLISHING CO.**  
45-C Vesey Street New York, N. Y.

## RADIO--From the Inside

Learn Radio from the inside. Complete course covering arc, spark and vacuum tubes. Day and evening classes. Positions guaranteed. First month's salary pays tuition. Call, write or phone—now!

"The Best Radio School in the East"  
"A JOB FOR EVERY GRADUATE"

## Y. M. C. A. RADIO SCHOOL

158 East 86th St., New York City  
Telephone, Lenox 6051

## Radio Supplies

All Standard Goods—Immediate Deliveries

Distributors for  
BALDWIN, BRANDES and BASCO PHONES,  
FADA, FEDERAL and MONROE  
RECEIVING SETS

Erla, Acme, Dubilier, Chelton, Burgess, Cunningham, Magnavox and many others. A Complete Line. Largest Stock in the Middle West. Write for latest Catalogue.

DEALERS NEW ATTRACTIVE DISCOUNTS

**American Radio Mfg. Co. Dept. A.**

107 E. 13th St., KANSAS CITY, MO.

## EISEMANN

RADIO UNITS

Made to the highest electrical and mechanical standards.

EISEMANN MAGNETO CORP'N  
Chicago BROOKLYN, N. Y. Detroit

Parts and Accessories for makers of radio apparatus

## GERACO

PROVED RADIO PRODUCTS

Details and Prices on request

**GENERAL RADIO CORPORATION**

Mfrs. & Distributors of

First Quality Radio Equipment

including MUSIC MASTER RADIO AMPLIFIER

624-628 Market St. Philadelphia

## VULCANIZED

## FIBRE

Be sure and specify

## "WILMINGTON FIBRE"

Sheets, Rods, Tubes, Washers, Etc., Specialties

Wilmington Fibre Specialty Co., Wilmington, Del.  
Branch Offices "Everywhere"

tions. I think that most of this is from commercial stations working on 450 meters and not from amateur stations as is frequently stated, as I operate a short wave receiver when home and have no trouble from 200 meter spark stations, but get quite a lot of QRW from ships on 450, as these stations are licensed to work on that wave. The only remedy is to get a set which is more selective in its tuning qualities.

JOHN A. WAIR,  
Radio operator, S.S. Blossom Heath.

**8ATR BREAKS IN**

Editor, RADIO NEWS:

I wish to reply to the letter by Edward C. Spengeman as published in the December RADIO NEWS.

To begin with, I would like to know what he means when he says, "An amateur who is filling the air with a lot of annoying spark nonsense, merely aimless chatter."

Does he realize what he is saying? Surely he cannot. How long since it is the novice's place to criticize the veteran amateur?

I wish to assure Mr. Spengeman that all amateurs are not so "intolerant and bigoted" as Mr. Hardenbergh.

Mr. Spengeman displays his ignorance of real radio amateurism by this very statement. I think it would be well for him to make the acquaintance of some real amateurs. He will find them willing to help him with any problems and co-operate as much as possible.

Of course the amateur has his rights, too. Mr. Spengeman cannot expect important A. R. R. L. work to cease merely because a few novices wish to listen to a concert.

I also wish to call his attention to the fact that the majority of amateur stations are engaged in important relaying work which must be carried on, and not the minority. If Mr. Spengeman can copy code so much faster than the average amateur why doesn't he get an operator's and a station license and have a transmitter himself?

One thing more. A C. W. transmitter tunes so sharply that it causes absolutely no QRM a half mile away with a properly designed single circuit receiver on 360 meters.

As long as Mr. Spengeman holds the attitude that amateur radio is a waste of time he will get nowhere, and also if he persists in this attitude he will never be accepted as a real dyed-in-the-wool amateur.

Come on, OM, get out of that rut. Go to the Radio Club meetings in your town, meet the amateurs, talk with them, and you will change your opinion, I'm sure.

Wasn't it the amateurs who advanced radio? The amateurs who helped the government during the World War?

There, I've got that off my chest, so will sign off.

SELYE WHITMORE, 8ATR,  
Rochester, N. Y.

**LEARN THE ART FIRST**

Editor, RADIO NEWS:

I have been reading your magazine for about four years and the knowledge I have gained through it in regards to radio has made it possible for me to enjoy the radiophone concerts which are being conducted at the present. You have explained the intricate parts in a most clear and concise manner.

What I wish to speak of principally are the aspiring critics who rave about how the radio game should be run. I have been at the radio game for about sixteen years and I have this to say about the person who would have the radio amateurs banned from the air. "To study RADIO NEWS until they have sufficient knowledge to construct and operate a set that will not respond to wave-length varying from one

**WABASH RAILWAY COMPANY**  
November 30 1922

Mu-Rad Laboratories, Inc.  
800 Fifth Avenue,  
Asbury Park, N. J.

Gentlemen:

It is a pleasure to report the result of the tests which were recently conducted on Wabash trains No. 2 and 5 with one of your Mu-Rad Radio Receivers.

The Mu-Rad Receiver with a 2' loop aerial was set up in all-steel club car placed in the middle of a train of fourteen cars which left St. Louis for Kansas City at 11:00 P.M. on the night of November 28th. Some forty persons were present in the car and were very elated at hearing on the horn the signals from the St. Louis Post Dispatch broadcast station and from the Kansas City Star. The signals were very clear and strong up to the time the broadcasting shut down.

The morning of November 29th a second test was made on the train running from Kansas City to St. Louis, the Mu-Rad equipment of this test being set up in the observation car. On this return trip three stations in Kansas City, one in Wichita, Kansas, one in Jefferson City, Mo., one in Atlanta, Ga., and one in St. Louis, and the Schenectady, N.Y. station, were all picked up very clearly.

Persons who witnessed the tests considered the performance the most wonderful radio achievement they had ever seen expressing surprise at the clarity and strength of signals received on a small loop aerial particularly within an all-steel car during daylight.

Yours very truly,  
H. E. Watts  
Passenger Traffic Manager.

*The New Star in the Radio World*

What the Railroad said about the performance of the Mu-Rad Set on the Wabash Express

**MU-RAD**  
**Radio Frequency Amplification**

**Triumphs in Test on Express Train**

The entire radio world is agog at this latest supreme achievement—the reception of radio programs inside a steel car, with no outside aerial or ground, moving at express speed—the severest test ever given any receiving apparatus.

A striking demonstration of the great sensitivity, extremely accurate selectivity and absolute simplicity of operation of Mu-Rad Receivers.

The difference between Mu-Rad and other apparatus is great enough to be worth your while insisting on Mu-Rad Receivers. Guaranteed reception of 1000 miles.

- Type MA-12 3 Stages R. F. and Detector \$128
- Type MA-13 3 Stages R. F., and Detector and 2 Stages A. F. \$160

DEALERS: Write for interesting proposition.

**Mu-Rad Laboratories, Inc.**  
801 Fifth Ave., Asbury Park, N. J.

*They copied all they could copy,  
But they could not copy our mind;  
We left them tearing and swearing  
A thousand miles behind.*

—Kipling

**A Real Adapter for the WD 11 Peanut Tubes**

Highly polished moulded Bakelite. Split brass tube sockets for D11s.

**\$1.25**

Moulded Bakelite Socket for WD11 Tubes, \$1.00

Write for Radio Catalog

**THE WIRELESS SHOP**  
A. J. EDGOMB  
1262 West Second St., Los Angeles, Cal.

**RADIO PRICES SMASHED**

We now announce drastic cuts in our quality lines. All goods prepaid and sold subject to return for rebate or exchange. You simply must be pleased. A sample saving follows. Order from following or send for full list today

COMPLETE REGENERATIVE VACUUM TUBE RECEIVER

	Our price	Others
Range approximately 1000 miles	\$17.75	\$2.50
Panel of bakelite 7 in. x 12 in. drilled	1.50	2.50
Cabinet of 3 ply wood to fit panel	.70	1.40
2 three inch dials @ .35c each	.70	.45
16 switch points with nut @ 01c.	.16	.12
4 switch stops with nut @ 01c.	.04	.12
8 binding posts, Nickel plated @ 01c.	.08	.16
12 plate variable condenser	.24	.50
1 filament rheostat, High grade	.50	.90
1 vario-coupler with fourteen taps	.65	1.10
1 23 plate variable condenser	2.25	4.00
1 tube socket of high quality	1.95	3.50
1 tube socket of high quality	.45	.85
1 phone and 1 grid condenser @ 15c and 20c.	.35	.65
12 feet spaghetti tubing @ 04c.	.48	.84
1 tube socket support	.15	.25
15 feet copper connecting wire	.15	.30
1 set blueprints for assembling	.10	.25
	\$11.42	\$20.12

Some other articles taken from our price list are—

Cunningham detector tubes	4.25	5.00
Transformer-Audio frequency	2.95	4.50
Front Face—2000 ohms	3.95	5.00
Two step amplifier parts complete	12.95	21.50

**Radio Parts Manufacturing Company**  
2150 Montclair Dept. "N" Detroit, Michigan

# AMES

## Radio Products

Manufactured in our modern plant under expert supervision. All products fully guaranteed.

### Specify Ames—for results



**AMES VARIOMETER and VARICOUPLER**

In appearance and efficiency second to none. Cotton covered or enamel wire. Base or panel mount.

Prices—  
Varicoupler \$6.00  
Variometer 6.50

### AMES AUDIO FREQUENCY TRANSFORMER

Designed especially to eliminate distortion, for the reception of speech and music. Completely encased in nonmagnetic metal for shielding. Ratio 4½ to 1.

Price .....\$5.00



### AMES VARIABLE CONDENSER

Accurately spaced plates and rigid construction eliminate "shorts" and unequal variations of capacity. Insulation is genuine Micarta. Patented top and base.

Prices  
11 plate .... \$2.00  
23 plate .... 2.50  
43 plate .... 3.00



If your dealer can't supply you, write us direct.

Special Proposition to Dealers and Agents.

### PICARD RADIO CORPORATION

Wholesale Distributors

Dept. Y, 18 West 46th Street, New York

hundred to three hundred meters without touching a knob and to learn that we are a race that is graduated from the hour-glass type to a race of precision and efficiency." There are plenty of amateurs around here, but they do not disturb my equanimity when I am receiving Denver or Salt Lake. A friend of mine has one two blocks from me and he disturbs his share of the ether, but never interferes with my reception unless I get down on his wave.

As to your magazine, you sure know how to take care of the food for your linotype machines. Let us have a little bit of everything pertaining to radio. This tends to make us broad-minded and considerate of our fellow men. And amateurs, novices, laymen and professionals, let us live in peace for the advancement of the radio art, as everyone has a place in its founding and maintenance.

E. RAEHRS, Coalinga, Calif.

### A REAL OLD TIMER SPEAKS

Editor, RADIO NEWS:

Mr. Ray Hardenbergh's letter printed under "Correspondence from Readers," in RADIO NEWS for September, 1922, has given to RADIO NEWS an uncalled-for knock and I believe that, were Mr. Hardenbergh one of our real "oldtimers," his letter would surely rest heavily on his conscience.

Possibly there may be one or two others along with Mr. Hardenbergh who believe that RADIO NEWS is signing its death warrant by keeping up with the developments of radio and in giving space to broadcasting and radiophone work, but I think I speak for all the "oldtimers" and commercial operators as well as the new "bugs" when I say that RADIO NEWS is to be commended on the excellent way in which it has kept its readers posted on the enormous progress made in radio in the past few years.

I have not missed a copy of this magazine since its birth, nearly ten years ago, when it had only about a dozen pages, but what was between the covers was "real stuff," and in my experience as amateur, commercial, navy, and army operator and government radio officer, I have found RADIO NEWS very valuable.

The majority of us wish to keep abreast

## ANNOUNCING

the consolidation

of the

**National Fibre & Insulation Co.**  
**the Keystone Fibre Co. and the**  
**American Vulcanized Fibre Co.**

In order that we may unify our efforts to better serve our customers and through them the public—we have consolidated and in the future will be known

as the

**NATIONAL VULCANIZED**  
**FIBRE CO.**

of

**WILMINGTON**  
**DELAWARE**



# AT LAST—PERFECT CONTROL WITH THE RESIST-O-METER

"Better than a Rheostat"

We manufacture the following:

RESIST-O-METERS  
Type A—Filament  
Type B—"B" Battery  
Type C—Potentiometer

TEST-RITE CONDENSERS in the following capacities:

Phone .001 Mfd.  
Grid .00025 "  
Grid .0005 "  
Grid Leak .0005 "  
1-meg.

V.T. Sockets  
Engraved Binding  
Posts  
Accessories

WHEREVER you find a radio set with a Resist-O-Meter you will find an operator who at last has secured a really satisfactory variable resistance.

The Resist-O-Meter is a remarkably simple device, and inexpensive, yet gives the infinite variation in resistance so necessary to perfect electrical control.

The results speak for themselves.

### The "Resist-O-Meter"—A Scholes Product

—is a micrometer control and gives continuous variation between the extreme ranges of its ohmage.  
—is non-microphonic.  
—is supplied with adjustable brackets for mounting, making new screw holes in panel unnecessary.  
—is compact and convenient, and takes up very little space in standardized mounting.  
—is made in models covering every requirement for radio use.  
—possesses the lowest resistance at full compression (practically zero).  
—the resistance material cannot pack.

The Scholes Radio & Manufacturing Corporation holds the sole license to manufacture this type of current control, under patents granted Mr. F. A. Rojas, Nos. 15478 and 1366945, other patents pending. It is sold only under trade name "Resist-O-Meter." Ask your dealer to supply you.

Write to Mr. H. L. Demuth

**THE SCHOLES RADIO & MANUFACTURING CORPORATION**  
32-36 West 18th Street, New York City

## Sell Us Your Spare Time We Pay Spot Cash!

And the Big Season is Just Commencing.

Radio News and Science & Invention are the two largest radio magazines—known everywhere—and they require solicitors in every community, to obtain renewals from present subscribers and new subscriptions from others.

We pay a big commission—the same for renewal as for new subscriber.

No experience required—nothing to learn—write for order forms, sample magazines, etc., to

**C. J. WOLFE,**  
Experimenter Publishing Co.,  
53 Park Place, New York.

Insure your copy reaching you each month. Subscribe to Radio News—\$2.50 a year. Experimenter Publishing Co., 53 Park Place, N. Y. C.



of the times and not remain in the same old rut, and for that reason RADIO NEWS is read by practically every amateur, commercial and government operator.

That time referred to by Mr. Hardenbergh as when RADIO NEWS will be stranded will happen at the same time that Niagara Falls runs backwards.

Here's wishing RADIO NEWS continued success and prosperity.

H. S. GATES, Chief of Radio,  
2nd Lighthouse Dist.

Care of U. S. L. H. Depot,  
37 Marginal St.,  
Chelsea, Mass.

**A REPLY FROM A HAM**

Editor, RADIO NEWS:

I wish to reply to Messrs. W. Swallow's and G. C. Bradley's letters appearing in the November issue. They interest me for the reason that I, or any other ham, never heard of an amateur transmitting on wave-lengths from 360 to 1,000 meters. In the first place, very few amateur stations can tune their transmitters as high as 360.

The amateur wave-length is 200 meters. Many amateurs exceed this, it is true, but the highest I've ever heard of was 235. It is no easy matter to tune 200 sharp with appreciable radiation.

Once, in a radio store, I heard a chap say that whenever XXX pressed his key he interrupted reception of the concert this chap was receiving. This chap cannot read the code, but as is the custom with all who cannot, blames it on the very convenient amateur. I am located about four blocks from XXX, and am never interrupted on a wavelength ten meters difference. So I lectured this chap and looked over his set.

Another time a fellow once told XX that whenever ZZZ works he is always interrupted. XX and ZZZ can stand on their roofs and shout to each other. So XX looked over this chap's set. This fellow could read the code, so he knew what he was talking about.

Well, both chaps have junked their sets. They now have real tuners. It was the old story of the super-selective, single circuit tuner.

I do not know what sort of set you have, gentlemen. If it is a regular three-circuit, then I believe that you are not thoroughly familiar with the tuning. I will stake a good tube, then, that you get 600 meter sparks, or navy sparks, or anything of that sort—providing your set is not a single circuit tuner. Will you take me up?

The amateur is a fine fellow, gentlemen. His is the love of the game. Were it not for him you would not be enjoying the broadcasts. But is he not at least entitled to the air part of the time? He begins his work after 10:30 P. M. The average fan is in bed at that time.

The amateur will help you cut out that interference. If you will let me have your address I will ask some ham to help you. We are at your service.

D. F. KIRCHICK,  
409 Osborn St.,  
Brooklyn, N. Y.

P. S. The calls herein are fictitious. I will supply the correct calls upon request.  
D. F. K.

**A CANADIAN SUGGESTION**

Editor, RADIO NEWS:

After reading the many articles which have appeared from time to time in RADIO NEWS in re the Amateur vs. Broadcast-listener, I would like to offer a few suggestions. In the first place, let me state definitely that the following is taken from the Canadian side of affairs, and while it may apply, in one way or another, to the American side of things, it has absolutely no bearing whatever upon them.



J-107 \$6.50  
Portable Type Variable  
Condenser  
J-108 \$5.50  
Panel Type

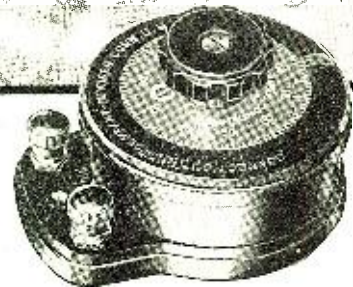

*What determines signal strength  
in Variable Condensers*

Strength of signals, when you use a Variable Condenser, depends upon *low* "effective resistance." In most ordinary commercial types this resistance lies between two and fifteen ohms.

Compare this with the CONNECTICUT Variable Condenser, about two-tenths of an ohm. This low comparative resistance not only permits, but insures, strength of signals.

There are other advantages—compactness, fine adjustments, stable in any position, sensitiveness—any one of which should make the CONNECTICUT type your choice of variable condensers. Every well-informed amateur should know about this condenser. We will gladly send you a booklet describing it.

**CONNECTICUT TELEPHONE COMPANY**  
Meriden & ELECTRIC Connecticut

**Thornton** Audio Frequency  
**Amplifying Transformer**  
"The Transformer Supreme"  
We still have territories open for Jobbers Write for particulars  
**Thornton Transformer Co., Inc**  
30 Church St., New York

**BAKELITE**  
**RADIO PARTS**  
Moulded To Your Design  
**Northern Industrial Chemical Co.**  
11 Elkins St. Boston, Mass.  
Moulders of Electrical Insulation

Get a Handy Binder for your RADIO NEWS. Holds and preserves six issues, each of which can be inserted or removed at will. Price 65c. Experimenter Pub. Co., Inc., Book Dept., 53 Park Place, New York.

# Dr. T. O'Connor Sloane Will Teach You CHEMISTRY Right In Your Own Home



DR. T. O'CONNOR SLOANE, Ph. D., A.M., LL.D., Ph. D., Educational Director, Chemical Institute of New York, formerly Treasurer American Chemical Society and a Practical Commercial chemist as well as a noted instructor.

Good chemists command high salaries. Industrial firms of all kinds pay tempting salaries to get the right men. Salaries of \$10,000 a year are not unusual for chemists of exceptional abilities. The work of the chemist is extremely interesting. If you are fond of experimenting, take up chemistry. If you want to earn more money, the way is open through our Course in Chemistry.

**You Can Learn at Home**  
Dr. Sloane will teach you Chemistry at home in a practical, intensely interesting way. Our Course is remarkably simple. No special education required—if you can read and write plain English you can thoroughly understand and master every lesson.

### Easy Monthly Payments

The price of our course is very low and the tuition includes everything, even the chemistry outfit—there are no extras to buy with our course. You can pay in small monthly amounts as you go along. Our plan places a chemical education within the reach of everyone.

### Experimental Equipment Given to Every Student

One special feature of our course is that we give to every student, without additional charge, the chemical equipment he will need for his studies, including forty-two pieces of laboratory apparatus and wooden box serves as a carrying case for the equipment and as a laboratory accessory for performing experiments.

### SPECIAL 30-DAY OFFER

In addition we are making a special offer for a short time only. You owe it to yourself to find out about it. Mail the Coupon to-day for free book, "Opportunities for Chemists," and full details of our special offer. Act immediately before this offer is withdrawn.

-CUT HERE-

CHEMICAL INSTITUTE OF NEW YORK, Inc. (Home Ext. Division, 3-A, 140-R, Liberty St., N. Y. City)  
Without obligation or cost, send me your free book, "Opportunities for Chemists," and full particulars about the Experimental Equipment given to every student, and tell me about your plan of payment and special 30-day offer.

Name .....  
Address .....  
City ..... State .....

## LEARN ELECTRICITY IN 3 MONTHS



Make this the most profitable and enjoyable summer of your life. Come to Chicago, the electrical center and the country's greatest summer resort city. Learn Electricity in America's oldest, largest and best equipped school. Earn your way, free employment dept.

**FREE R. R. FARE** If you come now we will pay your railroad fare and give you free a course in auto truck and tractor electricity, a course in radio, and a life scholarship in the great Coyne School. This is the greatest offer ever made by a school. Write at once for Particulars we can not keep this offer open long.

Write Today **Coyne** Trade and Engineering Schools  
1200-1310 W. Harrison St.,  
Dept. 5943 Chicago, Ill.

## Starting a Company?

Save expenses and taxes by organizing on the popular, COMMON LAW plan under a pure DECLARATION OF TRUST. No experience required to fill in DEMAREE STANDARD FORMS, issue shares and begin doing business at once. Genuine DEMAREE FORMS are nationally known, approved by attorneys and utilized by successful concerns throughout the United States. Send for large, free pamphlet (C-40) containing valuable information that you may need. C. S. DEMAREE, legal blank publisher, 708 Walnut, Kansas City, Missouri.



## RADIO CLUB PINS

An emblem made to order for your Club will work wonders—write today for free 52-page catalog, showing Radio emblems, class rings and pins. Samples loaned to officers.

METAL ARTS CO., INC., 7755 South Ave., Rochester, N. Y.

WHY not spend Spring, Summer and Fall gathering butterflies, insects? I buy hundreds of kinds for collection. Some worth \$1 to \$2 each. Simple outdoor work with my instructions, pictures, price list. Get posted now. Send 10 cents (NOT STAMPS) for my Illustrated Prospectus. Mr. Sinclair, Dealer in Insects, Dept. 37, Ocean Park, California.



Why is the amateur tied down to the 200 meter wave-length? So that he will not interfere with the ship traffic on 300 to 600 meters. Very good and wisely legislated. But now comes the part which is hard to understand. The broadcasting stations (of which we have quite a few throughout Canada, there being five or six licenses issued for Winnipeg) are licensed to broadcast on wave-lengths varying from 400 to 450 meters more or less. While it is true that these stations are in the hands of first-class operators, yet it does not prevent the broadcasting stations, both with their transmission and carrier-waves, from interfering with the ship-to-shore traffic. Now, here is my point: the amateur was set down to 200 meters (175 spark—1200 C.W.) and limited to 1/2 kw. power; the broadcasting station (even though it can be tuned closer for transmission than spark sets) has unlimited power, according to the license, unrestricted hours for working in a great many cases, and a wave-length which fits right into the ship-to-shore wave-length.

So far for the defects; now for the remedy: Supposing we leave the amateur at 200 meters and for the benefit of the broadcast receiver who always blames the amateur for the dots and dashes which interrupt his concert—whether they come from the amateurs or from ships on 300-600 meters—why not raise the wave-length of the broadcasting stations to 650-1,000 meters? This would minimize interference both for the commercial stations and the broadcast receiver. There is plenty of room in the air—but as things are now it is like the parking problem: plenty of room, but not where we, personally, want it;—therefore, if we move the broadcasting stations up to 650-1,000 meters we have left the amateur where he has plenty of room, the ship and shore stations—not forgetting the compass stations, of which Canada, as far as I can find out, boasts the large number of none, and the broadcasting stations with plenty of room for both concerts and carrier-waves. Some, perhaps, will think that this is all very well, but what about the increasing number of stations which all require space in the air? All right. At present we are crowding them into a band of about seventy-five meters and the addition of more stations will only help to make matters worse, whereas if we were to spread the allotted waves of close approximating stations over a fairly large band, by the time the number of stations had become exceedingly great, better tuning, for chiefly the broadcasting stations, will have been developed, making it possible to tune out broadcasting stations with a good regenerative receiver when they are using a wave varying in but a few meters from that which it is desired to receive from.

Yours for an agreeable settlement of affairs and leaving all the problems which are of the future to be solved by science and not by legislature.

RAYMOND LISTER,  
Canadian 4AP  
Winnipeg, Man.

## ABOUT THE FUTURE OF RADIO

Editor, RADIO NEWS:

The writer wishes to endorse heartily your editorial in the November issue of RADIO NEWS. It is the first frank expression of the most important phase of the radio business, from the point of view of all concerned, that the writer has read. Radio dealers of all kinds have been selling blindly to the public; blindly so far as the future good of the industry is concerned.

To sell a novice a regenerative set, involving, as many sales do, a two step amplifier with, say a Magnavox, is a quick and

## Red Devil Tools

### A Plier Worthy of Its Name



IT bears the "Red Devil" trade mark, which in short, means that it is sturdy—designed for hard work and long wear. It gives greater value and satisfaction for the money. "Red Devil" Slip Joint Plier—a general utility tool for all-around handiness. The slip joint increases the range of objects that can be gripped and multiplies the plier's usefulness.

Style No. 924—6 1/2 inches, 50c at hardware stores, or direct from our factory.

SMITH & HEMENWAY CO., INC.  
Manufacturers of "Red Devil" Tools  
273 Broadway New York, N. Y.

"Red Devil" Tools—American Made  
Pliers, Glass Cutters, Snips, Chain Drills, Screw Drivers, Hack Saw Frames and Blades, Wrenches, Cold Chisels, Punches, Lock Washers, Electricians' Tools, etc.

## ELECTRICAL Training Book FREE

Send me your name and address and I will send you my big new Electrical Training Book Free. It will show you how to qualify for high paying jobs in Electricity. Thousands now open. Prepare at home—quickly—during spare time under an Electrical Engineer. Take advantage of this unusual offer—only temporary.  
A. W. WICKS, President WICKS ELECTRICAL INSTITUTE  
Dept. 1077 3601 Michigan Ave. CHICAGO

## AMERICAN TIME CLOCK REPAIR & SUPPLY CO.

SECOND HAND TIME CLOCKS  
Bought, Sold, Repaired and Exchanged  
ALL WORK GUARANTEED  
We Carry a Full Line of Supplies

489 Broadway, near Grand St., Phone, Canal 7951

You can be quickly cured, if you

## STAMMER

Send 10 cents for 238-page book on Stammering and Stuttering, "Its Cause and Cure." It tells how I cured myself after stammering 20 yrs. E. N. Bogue, 884 Bogue Bldg., 1147 N. Ill. St., Indianapolis

## PATENTS Secured

Prompt service. Avoid dangerous delays. Send for our "Record of Invention" form and Free Book telling How to Obtain a Patent. Send sketch or model for examination. Preliminary advice without charge. Highest References. Write TODAY, J. L. Jackson & Co., 414 Ouray Bldg., Washington, D. C.

## INVENTORS

who derive largest profits know and heed certain simple but vital facts before applying for Patents. Our book Patent-Sense gives those facts: free. Write Lacey & Lacey, 531 F St., Washington, D. C. ESTABLISHED 1869.

## TELEGRAPHY

(Morse and Wireless) and RAILWAY ACCOUNTING taught thoroughly. Big salaries; great opportunities. Oldest, largest school. Endorsed by Telegraph, Railway, Radio, and Government officials. Expenses low—opportunities to earn large portion. Catalog free. DODGE'S INSTITUTE, D Street, Valparaiso, Ind.

### OLD MONEY WANTED

\$2 to \$500 EACH paid for hundreds of old or odd coins. Keep ALL old money, it may be VERY VALUABLE. Send 10 cents for New Ill's COIN VALUE BOOK, size 4x6. Get Posted. We pay Cash. CLARKE COIN CO., Ave. 79, Le Roy, New York

Write for free catalog illustrating and describing our complete line of 1500 Good Tools

GOODELL-PRATT COMPANY  
Toolsmiths  
Greenfield, Mass., U. S. A.

## A BETTER JOB NOW!

Learn good trade in a few weeks. 12 million autos, trucks and tractors need service. Repairmen needed. Write today for FREE catalog giving full particulars.  
MICHIGAN STATE AUTOMOBILE SCHOOL  
5343 Auto Bldg., Detroit, Mich.

certain way to kill radio in the vast majority of cases. The reception that the average novice secures with equipment of this type is simply offensive to the ear and ruinous to the business.

We are all to blame, to be sure, but concerted action from now on may give the public more faith in radio if those of us who are behind this great industry will heed the writing on the wall.

Of all the single tube receiving sets this company has sold, ninety-nine per cent have proved satisfactory and gained good will for radio. Of those sets including amplifiers not ninety per cent of the purchasers are getting results that help radio. Our territory does not permit the use of crystal sets because of distance from transmitting stations, but wherever possible the crystal should by all means be the first step in radio.

You have struck the keynote to a very serious mistake most dealers are making, and the writer hopes you will drive this point home with fire and brimstone.

C. F. MASSEY,  
Winchester, Va.

**BROAD WAVE OR POOR TUNER**

Editor, RADIO NEWS:

A perusal of your "Correspondence from Readers" page is most enlightening and one can judge very clearly from the tone of the different communications who is interested in the development of radio for the greatest benefit of the masses.

One is struck by the narrow-minded petty wailings of those who set up for themselves a class of super-intelligent beings, based almost entirely on the premises that they hold a license from the United States Government and can talk secretly with one another through the medium of the code.

The entire future of the amateur depends entirely upon his behavior and the amount of interference he causes to the many thousands who are enjoying a program of music and other arts. For some reason (perhaps super-intelligence) the amateur overlooks this fact. The great majority of amateurs are trying to do the right thing, but unfortunately, they stop right there. They overlook the fact that theirs is the responsibility of keeping within bounds their playmates, who insist on the right of way without regard to the many others with whom they interfere. The violator of the rules of common decency feels secure in the fact that the radiophone enthusiast, not being able to read code messages, never knows who his annoying neighbor is.

If the amateur would broaden his view and get over his sulks, he might find that the radiophone listeners afford him an audience whose cooperation would be the biggest boon to his game.

The fundamental cause of the tremendous feeling against the amateur is due to the lack of knowledge of the code by the radiophone listener. Why then, do not the amateurs through their Radio Clubs, inaugurate classes for the free instruction of the uninitiated? The dots and dashes would then become a message of interest and not one of annoyance. An intelligent message might then very likely cause the radiophone listener to leave his music to register this form of intelligence and who can doubt but that this would convert him to a most enthusiastic amateur?

It is up to the amateurs also to improve the kind of messages being transmitted and to keep to a minimum and at decent hours such chatter as one hears only too often.

A sample:  
GX1 calling 2BQ.  
Hello 2BQ.  
This is GX1 calling 2BQ.  
CX1 is calling 2BQ.



# Brandes

**F**EW realize that radio is old enough to have developed a strong industrial unit of 15 years standing.

Brandes *Matched Tone* Headsets were first made in 1908. The fact that they were designed perfect soundmates, matched in tone so as to catch even the faintest signals, solved the first and foremost problem of radio.

Brandes *Matched Tone* Headsets were indispensable when radio was in its infancy. They have grown more and more essential as time has gone on and the radio industry has expanded.

✉ Send ten cents in stamps for the "Beginner's Book of Radio." It explains radio in terms that anyone can understand.

*District Offices:*

76 Pearl Street, Boston, Mass.	33 South Clinton Street, Chicago, Ill.
709 Mission Street, San Francisco, Cal.	1220 Nicollet Ave., Minneapolis, Minn.
Munsey Building, Washington, D. C.	704 Granite Building, Pittsburgh, Pa.
802 Forsyth Building, Atlanta, Ga.	1028 Fourth Ave., Huntington, W. Va.

*Distributor in Australia and New Zealand:*  
International Electric Co., Wellington, N. Z.  
*Made in Canada and England by*  
Canadian Brandes, Limited, Toronto and London  
Distributed in Canada by Perkins Electric, Limited  
Toronto — MONTREAL — Winnipeg

**C.Brandes, Inc. - 237 Lafayette St., N.Y.C.**

## *Matched Tone*

TRADE MARK REG. U.S. PAT. OFF.

## Radio Headsets

**ATTENTION RADIOTICS**



If you use Amplifying Tubes you can make your Victor talking machine a **RADIO LOUD SPEAKER**, with a

**"BEEKO"**  
Radio-Phone attachment  
Price, 40c each  
*Liberal Discount in Quantities*

**J. H. Bunnell & Co.**  
Department X  
32 Park Place, New York

**RADIO CABINETS**  
Finished or Knock Down

**PANELS**  
Cut to Your Size

Quality **PARTS**  
Lowest Prices  
Direct to Consumer

**CHORALEON PHONOGRAPH & RADIO CO.**  
323 15th Street  
ELKHART, IND.

*Write Today*

**WANTED**—Back numbers of Radio News, Sept., Oct., Nov. and Dec., 1921, Jan. and Feb., 1922. Experimenter Publishing Co., 53 Park Place, New York City.

# W. L. DOUGLAS

**\$5 \$6 \$7 \$8 & \$9 SHOES** FOR MEN AND WOMEN

**W. L. Douglas shoes are actually demanded year after year by more people than any other shoe in the world**

**BECAUSE** W. L. Douglas has been making surpassingly good shoes for forty-six years. This experience of nearly half a century in making shoes suitable for Men and Women in all walks of life should mean something to you when you need shoes and are looking for the best shoe values for your money.

**W. L. DOUGLAS** shoes in style, quality, material and workmanship are better than ever before; only by examining them can you appreciate their superior qualities.

**No Matter Where You Live** shoe dealers can supply you with W. L. Douglas shoes. If not convenient to call at one of our 110 stores in the large cities, ask your shoe dealer for W. L. Douglas shoes. Protection against unreasonable profits is guaranteed by the name and price stamped on the sole of every pair, before the shoes leave the factory. Refuse substitutes. The prices are the same everywhere.

If not for sale in your vicinity, write for catalog.

**TO MERCHANTS:** If no dealer in your town handles W. L. Douglas shoes, write today for exclusive rights to handle this quick selling, quick turn-over line.

*W. L. Douglas*  
President  
W. L. Douglas Shoe Co.  
172 Spark St. Brockton, Mass.

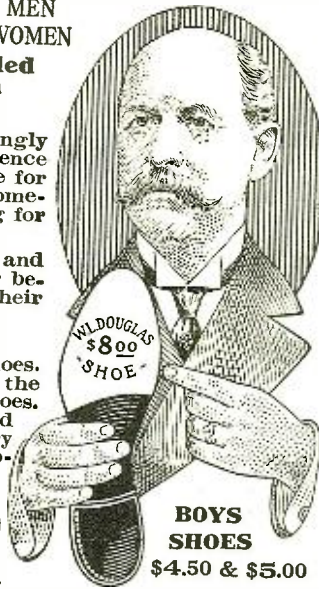

GXI is calling 2BQ.  
Hello 2BQ.  
Hello 2BQ.  
How do you get me?  
Call me by land wire.  
GX1 signing off.

The future security of the amateur is in his own hands, and if he is finally crushed under the wave of radiophone listeners, he can blame no one but his playmates who are becoming more brazen every day in their disregard of the rights of others.

R. A. ROWLANDS,

Schenectady, N. Y.

### TOO MUCH CODE

Editor, RADIO NEWS:

I pray you let me give these "amateurs" some straight talk. It seems to me they take a pathetic and very selfish attitude in this whole radio game. They claim to have discovered and perfected the radiophone. This doubtful fact we will grant them. Why then, ruin your own child, by persisting in code transmission, long since perfected and now for years a by-gone stepping stone. The answer is—it is for their own amusement—this man to man gossip is personal conversation. All right, they are entitled to their amusement. But not to 22 hours out of 24. It is amusing indeed to have the code-senders—not all "amateurs" are "code hounds"—say they will give the phone listener the two "best" hours out of the 24. And the spark gappers are outnumbered 200 to 1. It is the phone listeners who are bosses of the situation and in the end their desires shall be catered to—or radio will go back instead of forward as the code-senders proudly boast to be pushing it by sending code before 12 o'clock midnight.

I have a three bulb set on which, to date, I have tuned in and clearly and distinctly heard over 51 stations since Aug. 20th They are spread around between Cuba, Milwaukee, Kansas City and points east and north, and I defy any ten-year "amateur" to better that record or equal it by "wondrous" code-sending—long since outclassed by wonderful symphony concert music sent through the air from Chicago to my home—absolutely as pure as where it started, a thousand miles away. Yes, this is sarcastic, I mean it to be. Because of the discouraging times we have had with code-senders here—where two or three outlaws who make it all the worse for the near-reasonable amateurs—insist on code and phone-sending for their own private amusement to the detriment of the public. And mark it down in your code book now—we phone-hams are the public. And also without rigid laws we will always have outlaws.

The wonderful amateur has been over-advertised anyway. Did the man who perfected the party line telephone insist on talking when someone else was using the line?

Now here's what I, as a phone-listener and tuner think is very generous; we will give the code-senders all hours of every day except from 7 P. M. until 11 P. M. This gives the "kid" in the game plenty of after-school hours, the amateur from 6 to 7 or if that won't do, let him sit up late for his "art," or go without. I insist it is now a case of one man's personal amusement against the personal amusement of two hundred—real, educational, classical, etc. Let the code-sender stay off Sunday afternoon also. We will give him Saturday afternoon.

In our city after a strenuous time we finally got the overworked inspector up here; he did what he could to cut down the amateurs sending on over 200 meters. They were proved to have been sending on as high as 600 meters. Their names and all the facts were sent in. They were checked. Some new offenders appear—and one at least of the old offenders is with us—a so-called "outlaw." Mark my words, the code-senders under their present insistent attitude are

## BROADCAST YOUR BUSINESS MESSAGES ON A REGAL REBUILT ROYAL

Regal Rebuilt Royal Typewriters are stripped to the base and thoroughly rebuilt by experts.

They carry the same kind of a guarantee as a new typewriter.

Cash or monthly payments.

For sale by all responsible typewriter dealers everywhere,—or Write direct to

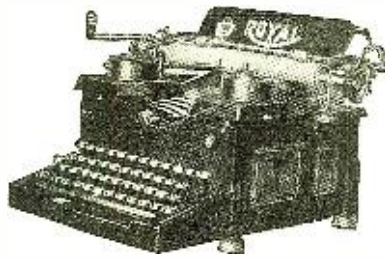

Genuine Regal carry this



Rebuilt Royals trade-mark.

**REGAL TYPEWRITER COMPANY, INC.,**

359 Broadway, New York, N. Y.

Marcus Harwitz - - - General Manager

## PATENTS If You Have an Invention and Desire to Learn How to Secure a Patent

Send for our Free Guide Book, **HOW TO GET YOUR PATENT.** Tells our terms and methods. Send model or sketch and description of your invention and we will give our opinion as to patentable nature. Our documentary **PROOF OF INVENTION** is intended for your protection and will be sent you without charge. Write for it.

**RANDOLPH & CO.**

Dept. 459 Washington, D. C.

NAME .....

STREET .....

CITY ..... STATE .....

## PATENTS

**C. L. PARKER**  
Formerly Member  
Examining Corps,  
U. S. Patent Office.  
PATENT - LAWYER  
McGill Bldg., Wash., D. C.

Patents, Trade Marks, Copyrights, Patent Litigation  
Handbook for Inventors, "Protecting, Exploiting and Selling Inventions," sent upon request.

### RADIO MAILING LISTS

- 12,400 Radio Dealers, covering U.S. by States... per M. \$7.50
  - 1,614 Radio Manufacturers, covering U.S. by States... per list 15.00
  - 1,757 Radio Supply Jobbers, covering U.S. by States... per list 15.00
  - 260 Radio Stations... per list 4.00
  - 257 Mfrs., who make and assemble complete Radio Sets... per list 4.00
  - 25,000 Radio Amateurs and Managers of Radio Stations... per M. 7.50
- Ask for price list covering Canada and England. Above ready to send on receipt of remittance.

Trade Circular Addressing Co., 166 W. Adams St., Chicago

doomed to be banished entirely, because the government will not provide money enough for a big competent staff of inspectors to watch the violators. The radio inspectors need a bigger appropriation. They have a tremendous job—always growing bigger. The phone-listeners must get busy themselves. Write Mr. Hoover and your congressman to speedily pass some rigid radio laws concerning concert spoiling; also appeal for the use of higher wave-lengths for broadcasting.

It's high time Congress investigated the terrible mess the air is in now. No, I haven't a cheap set—it stood me \$200 and is better than the average tuning set. Never mind the personal slurs, you code-senders! Come clean in your answers and admit you are outclassed and outnumbered 100 and more to 1, and remember the world moves on. Don't always remain a narrow-back.

A. D. ALDEMAN,  
Holyoke, Mass.

**SIGN OFF**

Editor, RADIO NEWS:

Referring to letter from Messrs. Swallow and Bradley, in the December issue of RADIO NEWS, I am inclined to take sides, as I am aware that some amateurs are a little out of the 200-meter wave and should be put into that class if they have no license to a higher wave. As Ex-president of the Rocky Mountain Radio Association of Denver, Colorado, I am in a position to state that a great many amateurs are a bit arrogant and do not confine themselves to their proper wave-length, nor have they made any attempt to get their decrement down to that specified by the U. S. Department. We Radioists who have been in the field since 1909, as I have, know the intrinsic importance of a well-tuned station, as compared with the hap-hazard, slipshod, thunder-producing variety; those that can be heard at any point on an inductance when you are within a few miles but not heard at all outside a small radius. I do firmly believe that if those persons whom we term "Broadcast fiends" would get the services of a qualified amateur to help them get the call letters of some of the stations who are annoying the 360 and 400 meter class of transmission and speak to those offenders, it would help to a far greater extent in curbing the nuisance than they imagine.

The code men were first, it is true, BUT—that should not mean that code should make a dog-in-the-manger proposition out of such an interesting, instructive, and beneficial art, hobby and pastime as RADIO really is. Another thing that truly gets my "GOAT" is the fellow who will carry on a conversation all evening and then sign off with a "K" and leave us sitting with a page or two of good wholesome matter but no signature of any kind to inform us as to who he is, where he is, or when we will hear him again. I say to you citizens, sign off with your call once a week anyway! Then if you happen to be a bit out of your allowance some one can do you a favor and let you know it.

In conclusion I wish to say that I still have a warm place in my heart for those folks who only got their sets to listen to the phone broadcasts and become very highly peeved if a code station gets into their concert or lecture. And even if they do say sarcastic things about me, and my favorite pleasure, they never apologize when they "gum up" a perfectly quiet night with their super-regenerative sets and poor, awkward management of same.

L. MARION SMITH,  
Pocatello, Idaho.

**GOOD DOPE**

DEAR SIR:

I saw in a letter to your editor a call for some amateur kinks. Due to a few

**Don't Waste Money, Time and Patience on Cheap, Improperly Designed Radio Parts. Insist on Getting New York Coil Company's Products, Which Insures Entire Satisfaction. Honestly Priced, Scientifically Constructed and Engineered to Deliver the Maximum Results.**

**JOBBER AND DEALERS** get our complete literature and worthwhile discounts.

Our 180 degree Variocoupler is a masterpiece, suitable for use in any circuit. Most efficient and best constructed Coupler in existence.

Price, \$4.50.

Our Combination Mounted Variocoupler for table or back panel mounting has all taps connected and soldered, nothing else like it. Price, \$8.00.

**MOUNTED 3 CIRCUIT TUNER.** Exceptional selectivity and sharp tuning, makes the most easily constructed and highest efficiency Set known. Price without Dial \$6.00. With 3¾ Bakelite Dial \$7.00.

Our Variometers are full size precision instruments. They are not of the "competitive" type. Price \$4.00.

Our Audio Frequency Transformers are the choice to the leading manufacturers and radio engineers. Guaranteed to give high magnification, less distortion and better all around efficiency. No howling. Price \$4.00.

**NEW YORK COIL COMPANY'S** Variable Condensers are the standard by which others are judged, containing such features as all metal framework, adjustable bearings and positive electrical contact:

11 Plate.....	\$1.50	43 Plate.....	\$3.00
23 Plate.....	2.00	3 Plate.....	1.25

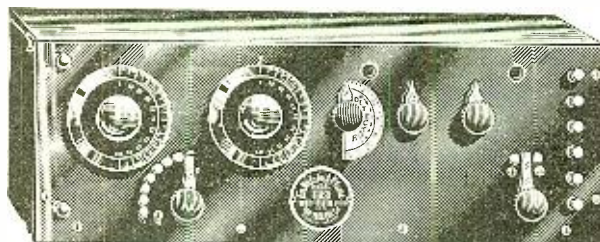
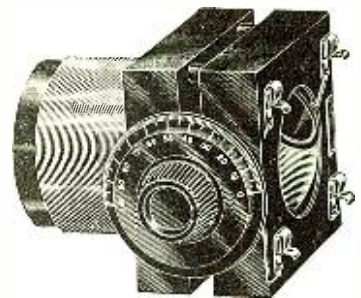

**NEW YORK ENTERTAIN-A-PHONE RECEIVING SET No. 2** — Complete with detector and two stages of amplification, all in one cabinet. Contains a non-regenerative two circuit hook-up with two stages audio amplification. Results are simply a revelation. It must be operated and heard to be appreciated. Workmanship and design and material of exceptional character throughout. Of unusual interest to the jobber. Price \$50.00, fully guaranteed.

**NEW YORK COIL COMPANY, Inc.**  
338 Pearl Street  
New York City, N. Y.

**LISTEN IN ON YOUR RADIO**

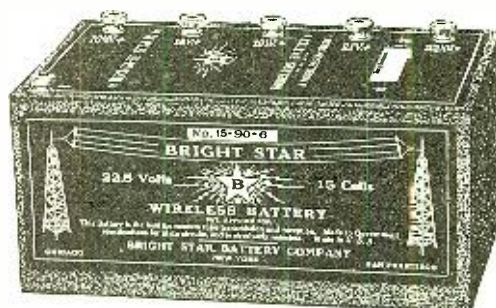

WITH  
**BRIGHT STAR "B" BATTERIES**

NOISELESS    LONG SERVICE    STRONG RECUPERATION

**Bright Star Battery Company**    NEW YORK  
CHICAGO  
PORTLAND, ORE.

# U.S. PATENTS



**SEND FOR THIS FORM**

## Don't Lose Your Rights

Before disclosing your invention to anyone send for blank form "Evidence of Conception" to be signed and witnessed. A sample form together with printed instructions will show you just how to work up your evidence and establish your rights before filing application for patent. As registered patent attorneys we represent hundreds of inventors all over the U. S. and Canada in the advancement of inventions. Our schedule of fees will be found reasonable. The form "Evidence of Conception" sample, instructions relating to obtaining of patent and schedule of fees sent upon request. Ask for them,—a postcard will do.



**LANCASTER & ALLWINE**

270 OURAY BLDG., WASHINGTON, D. C.  
\*Originators of form Evidence of Conception\*

# PATENTS

**To the Man with an Idea**

I offer a comprehensive, experienced, efficient service for his prompt, legal protection and the development of his proposition. Send sketch, or model and description for advice as to cost, search through prior United States patents, etc. Preliminary advice gladly furnished without charge. My experience and familiarity with various arts frequently enable me to accurately advise clients as to probable patentability before they go to any expense.

*Booklet of valuable information and form for properly disclosing your idea free on request.*

Write today.

**RICHARD B. OWEN**  
PATENT LAWYER  
2 Owen Building, Washington, D. C.  
2276A Woolworth Bldg., New York City

# Book Review

**THE BOOK OF RADIO.** By Charles William Taussig. 5½x8½ inches, 447 pages of text. Fully illustrated with cuts and diagrams. Published by D. Appleton and Company, 35 West Thirty-second Street, New York.

Advanced amateurs, and novices as well, will find in this book much interesting and useful material. Unlike a great number of books on the subject, it does not begin with a long and uninteresting theoretical discussion of radio. Instead, a bright and interesting chapter, entitled "Listening In," introduces the subject to the reader in the right manner.

Once the ground has been prepared, the author considers the technical matters, and does so as a logical sequence to the introductory chapter. His chapters on electricity, on the making of a receiving set for two dollars, continuous waves, vacuum tubes, aerial construction, and many others equally interesting, are brought to a close with a complete description of a receiving set, specially designed by the Bureau of Standards for broadcast receiving. A partial list of the more important broadcasting stations, a review of the U. S. Laws and Regulations governing radio, an abstract of the National Underwriters, are found in the Appendices.

This is one of the few good popular books in the field of radio literature.

**HOW TO MAKE LOW PRESSURE TRANSFORMERS.** By Professor F. E. Austin, Hanover, N. H. 4½"x7", 22 pages. Cloth cover. Fully illustrated.

A small book covering the design, construction and operation of small step-down transformers employing 110 and 220 volts 60 cycle alternating current supply. It is complete in its information covering this type of transformer and is a worth while addition to any experimenter's library.

**THE RADIO AMATEUR'S HAND BOOK.** By A. Frederick Collins. 5x7½" Cloth cover, 396 pages. Fully illustrated. Published by the Thomas Y. Cowell Company, New York.

A complete, authentic and informative work on radio telegraphy and telephony written in a comprehensive form, well covering the subject from its fundamental principles to the present stage of development. Design and constructional details are given for the building and assembling of both transmitting and receiving sets. The Armstrong super-regenerative circuit is fully described. The appendix contains much useful information. A fine book for the beginner.

**RADIO FOR ALL.** By H. Gernsback, *Editor of Radio News.* 5½"x8½". Cloth cover. 133 illustrations, 292 pages. Published by the J. B. Lippincott Company, Philadelphia, Pa.

In writing this volume, the author has continually had in mind a book for the beginner unacquainted as yet with the radio art. The theory of radio is carefully explained with drawings and illustrations. The broad features of the book include complete information as to how to make receiving sets, how to read diagrams and other useful radio data with the lists of all broadcasting stations in the United States and Canada and a map of United States Radiophone broadcasting stations suitable for hanging in the radio room.

Mr. Gernsback has succeeded well in combining a very large amount of valuable information between two covers.

**PRACTICAL RADIO.** By Henry Smith Williams. 5"x7½". Cloth cover. Fully illustrated. Published by Funk & Wagnalls Co., New York.

A practical guide to the design and construction of radio outfits from the simplest type of apparatus to the more elaborate equipment. This book, as well, covers the fundamental principles of radio, described in a comprehensive form. Mr. Williams makes the story of radio a fascinating narrative. Pictures in a large number have been used to supplement the text and these have been chosen not for their interest alone but also for their informative value. Anyone who follows the circuit diagrams and studies the text therewith, will gradually develop into an adept in utilizing radio as a practical art. "Practical Radio" will take its place as a leading text book in the radio world.

**RADIO HANDBOOK.** 4"x7". Leather covers. Fully illustrated. Published by Lefax, Inc., Philadelphia, Pa.

Dr. J. H. Dellinger, chief, and L. E. Whittemore, alternate chief, Radio Laboratory, United States Bureau of Standards, have prepared an interesting radio handbook, which carries with it many illustrations that will be helpful to those who desire to know the power and functions of the many parts. It is made in the form of a loose-leaf notebook, and with its purchase comes a postal card. By filling in the card the purchaser is entitled to a year's service of additional sheets describing new developments of both apparatus and hook-ups. The publishers realized that while radio is now a very big institution, it is true, nevertheless, that there will be many new developments, probably new parts and possibly new hook-ups.

A concentrated perusal shows that the book contains many helpful suggestions for the average radio fan.

Another interesting feature is the compilation of a list of nearly 500 broadcasting stations, which, besides being listed according to call letters, are listed geographically.

**THE BOOK OF WIRELESS TELEGRAPH AND TELEPHONE.** By A. Frederick Collins. 5x7½". 217 pages fully illustrated. Published by D. Appleton & Co., New York.

A good book for the beginner. It is written in a comprehensive form covering the fundamental principles of wireless telephone and telegraph. Some of the more advanced types of receivers and transmitters are clearly explained and the necessary information is given for constructing, operating and maintaining both receiving and transmitting stations. There is included in the rear, a list of the definitions of words and terms commonly used throughout the book. Mr. Collins has succeeded in putting forth the facts of radio in an interesting and practical fashion.

**DIRECTION AND POSITION FINDING BY WIRELESS.** By R. Keen, B. Eng., A.M.I.E.E. 5½"x8½". 376 pages illustrated. Over 250 photographs and diagrams. Published by The Wireless Press, New York.

This book fully covers every phase and term of position finding developed in England. From early experiments up to the present approved systems, nothing is left out. This treatise not only deals with the principles of the subject but also with the constructional details of direction finding installations for shore service and for the navigation of ships and aircraft; also with such subjects as the use of special maps for D. F. work, the freak phenomena which cause errors in bearings and the elimination of faults peculiar to the D.F. receiver. The last chapter on field and nautical astronomy is very useful in connection with the practical application of direction finding.

## NAR AND NAY

Effective January 15, 1923, the weather reports, forecasts, and warnings are being broadcast from the Naval Radio stations at Key West, Fla., and Point Isabel, Tex., on both continuous wave and spark transmission as follows:

Key West, Fla., NAR, 10 p. m. (75th meridian time), wave-lengths, 5,700 meters, C.W. and 1,988 meters, spark.

Point Isabel, Tex., NAY, midnight, noon, 7 p. m. (75th meridian time), wave-lengths, 5,000 meters, C.W., and 2,250 meters, spark. Hurricane warnings are broadcast whenever issued and repeated at 2-hour intervals until midnight on both wave-lengths.

Weather Bureau Circulars dated October 26, 1920, and May 28, 1921, are amended accordingly.

# PATENTS TRADE-MARKS AND COPYRIGHTS

Before disclosing an invention, the inventor should write for our blank form "RECORD OF INVENTION". This should be signed and witnessed and if returned to us together with model or sketch and description of the invention we will give our opinion as to its patentable nature. Radio and Electrical cases a specialty.

Our illustrated Guide Book, "HOW TO OBTAIN A PATENT," sent Free on request. **Highest References Prompt Attention Reasonable Terms**

FREE COUPON

**VICTOR J. EVANS & CO., Patent Attorneys**

Chicago Offices: 1114 Tacoma Bldg.	Pittsburgh Offices: 514 Empire Bldg. New York Offices: 1001	Philadelphia Offices: 714-715 Liberty Bldg. Woolworth Bldg.	San Francisco Offices: Hobart Bldg.
---------------------------------------	---	---	--

MAIN OFFICES: 919 NINTH, WASHINGTON, D. C.

Name ..... Address .....

narrow-minded persons, the amateur and the novice are at swords' points. The novice of today is the amateur of tomorrow. We cannot stamp them out. They are here to stay, and we as A. R. R. L. members will help them in any way possible to obtain success in their new-born hobby. These narrow-minded amateurs are kicking themselves. Do they read QST? Do they see the department for the novice? So that he can be acquainted with both sides, the average amateur is fair; he is civil like the rest and he will go 50-50 any time.

If a novice is having trouble and gets only spark stations, go to his house some time before 10:00 P. M., E. S. T., as the time set for relay traffic to begin, and help him out. Tell him who he gets. The days of amateur SPK are over and C.W. is rapidly taking its place. True there are a few left, but they will wise up later on. The manufacturer is to blame for bringing out a single current receiver—because then recurrent is like a spark coil and no helix. They are the worst blow to radio development on both amateur and broadcast point of view that the world could imagine.

MALCOLM GAGER.  
1430 College St., Dunmore, Pa.

P. S. My P. S. will not be a dare to print this one, but just to let you know that our town has no trouble with amateur and novice calling up each other since the town is civilized, and, in fact, the novice looks to the amateur for help, and a broad-minded A. R. R. L. man gives it to him and he is repaid by friendship. M. G.

**ANOTHER ANGLE**

Editor, RADIO NEWS:

On page 1189 of the December issue of RADIO NEWS, I noticed an article by Mr. Spengeman in which he seems to think that the radio amateur is nothing more than a thing which sits around and sends unearthly noises much to the discomfort of the "broadcast fans." I think his disagreement with Mr. Hardenbergh is in some ways just, but when he said that all an amateur could do was clutter up the air for miles around, that made my anger rise. Most of the amateurs of today are relaying the A.R.R.L. messages. As he says of Mr. Hardenbergh, if all the broadcast fans are as intolerant and bigoted as Mr. Spengeman they should be kicked off the earth. Broadcasting is all right, but when it lasts until the late hours of the night I cannot see why an amateur, with much more important business than the broadcasts, should not get his traffic off after ten o'clock.

Just think of it. After we old amateurs have developed his broadcasting radiophone, he does not even want to tolerate us. Broadcasting would never have been heard of had it not been for the amateurs who developed it. Again how can he get any education out of the talks by radio, as he says he does, if he is tuning around trying to find out what the amateurs are saying. I think I may safely say that I live as close to some big amateur stations as he does and I can tune any of them out on 360 meters, even a 1 k.w. spark who radiates something like 8 or 9 amperes, and I cannot hear him on a 360 wave.

I am inclined to believe that he has a poor set or does not know how to tune it.

As to his reference to RADIO NEWS, I think it is all right, not too much amateur or too much broadcast. It is O.K. as it is.

I hope you can see my argument and publish this for the benefit of the aforementioned Mr. Spengeman. I would like to see some discussion on this matter and I think if it were carried out he would see that broadcast fans are not the only people on Earth. Thanking you very much for your time will CUL and best 73's.

LINTON H. FLOCKEN,  
Radio 9BEB,  
Urbana, Illinois.

**PRESIDENT HARDING -**

We venture to predict our President will address the nation. Let Tuska Reliable Radio make you a part of his audience.

Tuska Quality Radio Apparatus means a lifetime guarantee of reliable service.

Ask for Tuska Radio at your dealers today.

**The C. D. Tuska Company**  
50 Bartholomew Ave.  
Hartford, Connecticut

**TUSKA RADIO**  
Established 1911

*Catalog Number Four contains Marvellous article on tuning Receiving Sets Ten Cents brings it to you*

**It's the contact that counts**

The special phosphor bronze clips of the Na-ald W. D. 11 Socket maintain perfect contact regardless of any variation in tube prongs and bases. Moulded from genuine Condensite, these sockets are made for use with the famous W. D. 11 tubes, operated by a single cell battery. The Na-ald De Luxe V. T. Socket is of highest quality throughout. Its laminated phosphor bronze strips press firmly with a side wipe action on the contact pins, keeping surface clean and insuring perfect contact.

Send stamps for dial, small-space socket, condenser and R.F. transformer circulars.

These sockets retail at **75c** each

**ALDEN-NAPIER CO.**  
Dept. k 52 Willow Street  
Springfield, Mass.

**NA-ALD**

**Standard Radio Horn**

Standard Radio Horn made in rubberoid, black enamel finish. Made in 3 Sizes. 14" Bell 24" high, list \$12. 7" Bell, 19" high, list \$7.50. 5" Bell, 14" high, list \$5. Gem 11" Bell, 14x16", list \$7.50.

Manufacturers! Let us quote you prices on special horns to meet your requirements

Write for particulars

**Standard Metal Mfg. Co.**  
231 Chestnut St.  
Newark N. J.

# OPPORTUNITY AD-LETS

Follow these advertisements every month. Reliable advertisers from all over the country offer their most attractive specials in these columns.

Classified advertising rate fifteen cents a word for each insertion. Ten per cent discount for 6 issues, 20 per cent discount for 12 issues. Name and address must be included at the above rate. Cash should accompany all classified advertisements unless placed by an accredited advertising agency. No advertisement for less than 10 words accepted.

Objectionable or misleading advertisements not accepted. Advertisements for the May issue must reach us not later than March 1st.

## THE CIRCULATION OF RADIO NEWS IS OVER 225,000

EXPERIMENTER PUBLISHING CO., INC., 53 Park Place, New York, N. Y.

### Agents Wanted

\$75-\$150 weekly assured if you hustle. Sell attractive gold signs to stores, offices. Unlimited demand. Experience unnecessary. Free Samples. Aeme Sign Co., 363 W. Superior, Chicago.

Big Money and fast sales. Every owner buys gold initials for his auto. You charge \$1.50; make \$1.35. Ten orders daily easy. Write for particulars and free samples. American Monogram Co. Dept. 133, East Orange, N. J.

Ambitious men, write today for attractive proposition, selling subscriptions to America's most popular automobile and sportsman's magazines. Quick sales. Big profits. Pleasant work. Digest Pub. Co., 9528 Butler Bldg., Cincinnati.

Amateur Agents Wanted in every city and town to sell radio apparatus. A few stocking agencies still open. Delfeco, 12 Meeting Street, Pawtucket, R. I.

We Wish Representatives in every community to secure subscriptions for Radio News, Science and Invention, and Practical Electrics. This is a wonderful opportunity for Amateur Radio Enthusiasts to make big money quickly. Write Experimenter Publishing Co., Inc., 53 Park Place, New York City.

Agents—Salesmen—Big money selling complete Radio Sets—Experience unnecessary. Cash in on our adverstising. Protected territory. Home Radio Co., 115 N. Desplaines, Chicago.

Agents—\$15 a Day—Easy, quick sales—Free Auto—Big weekly bonus—\$1.50 premium Free to every customer. Simply show our Beautiful, 7 piece, Solid Aluminum Handle Cutlery Set. Appeals instantly. We deliver and collect. Pay daily. New Era Mfg. Co., 803 Madison St. Dept. 87A, Chicago.

Radio Agents wanted in every town. We are manufacturers of long distance sets and parts. Write for plan. Picard Radio Corp., Dept. R, 16 W. 46th St., New York.

Amateur Agents wanted in every city and town to sell the Radioscope—the wonder crystal set. Write for information—The Radioscope Mfg. Co., 128 No. Main, Providence, R. I.

Tremendous Opportunity for ambitious agents. The indispensable rapid selling Speedy Dish Washer. Price \$3.50. No competition. No investment. Easy selling plan. Convenient sample. Commission daily. Make application to-day—exclusive territory. Sheppard-Luth Mfg. Co., 16 Z Hudson St., New York.

Build Your Own Business—Renewing and dyeing rugs and carpets on floors of offices, hotels, homes. New Method. Big profits. \$10 Day easy. Write for full information. Texply Company, 12-A, Somerville, N. J.

Agents Wanted in every city and town to sell standard radio apparatus. Attractive discounts given. If interested, write us at once stating age and radio experience. Wilmington Electrical Specialty Co., Inc., 912 Orange St., Wilmington, Delaware.

Free Book. Start little Mail Order business anywhere. Home employment evenings. Beginners' Working Outfit furnished. Instructive Book Free. Pier Dept. 155-A, 74 Cortlandt St., N. Y.

\$35.00 Profit Nightly. Small capital starts you. No experience needed. Our machines are used and endorsed by government institutions. Catalog free. Atlas Moving Picture Company 483 Morton Bldg., Chicago.

A Vacuum Tube Hospital. We repair vacuum tubes and guarantee them to work. Dealers, agents wanted. George H. Porel Co., Inc., West Somerville, Mass.

### American Made Toys

Manufacturers on Large Scale, also homeworkers, wanted to manufacture Metal Toys and Novelties. Millions needed of Barking Dogs, Wag Tail Pups, Wild Animals, Automobiles, Indians, Cowboys, Baseball Players, Cannons, Toy Soldiers, Crowing Roosters, Statues of Liberty, Miniature castings of Capitol, Bathing Girl Souvenirs and others. Unlimited possibilities. Guaranteed Casting forms furnished manufacturers at cost price from \$5.00 up, with complete outfit. No experience or tools necessary. Thousands made complete per hour. We buy goods all year and pay high prices for finished goods. Cash on delivery. Contract orders placed with manufacturers. Catalog and information free. Correspondence invited only if you mean business. Metal Cast Products Co., 1696 Boston Road, New York.

### Automobiles

Automobile owners, garagemen, mechanics, send today for free copy America's most popular motor magazine. Contains helpful articles on over-hauling, re-pairing, ignition, carburetors, batteries, etc. Automobile Digest, 528 Butler Bldg., Cincinnati.

### Chemistry

Learn Chemistry at Home—Dr. T. O'Connor Sloane, noted educator and scientific authority, will teach you. Our home study correspondence course fits you to take a position as chemist. See our full page ad on page 1605 of this issue. Chemical Institute of New York, 140 Liberty Street, New York City.

### Books

Hypnotism—Astounds: controls others. 25 easy lessons. \$1.00; Dr. Braid's Wonderfully Successful method, \$1.10. "Mindreading" (any distance), 30c; "400 Valuable Trade Secrets" (one cost \$250.) 25c; "Cleopatra's Beauty Secrets Revealed," 25c; "Love's Mysteries Solved," 25c; How to Attract Friends; Be a Leader with Strong Will, Good Memory, Magnetic Personality," six books, 65c; "Successful Moving Picture Playwriting," 25c. Everything mentioned \$3.50. Catalog free. Science Institute, RN1014 Belmont, Chicago.

Sexology Books only for professional and advanced student readers. Forel, Krafft-Ebing, Kisch, Robie, Ellis, Fraud, Key and other authorities. The Modern Book Association, 4150 Santa Monica Blvd., Los Angeles, Calif.

### Business Opportunities

Become a Landscape Architect. Dignified, Exclusive Profession. Little competition. \$5,000.00 to \$10,000.00 income for experts. Easy by our method. Begin earning 3 weeks after you enroll. Write today. American Landscape School, 11R, Newark, N. Y.

Advertise. Country town newspapers. Lists free. Pen-nell Company, Covington, Kentucky.

### Correspondence Courses

Dollars Saved—Used correspondence courses of all kinds sold, rented and exchanged. List free. (Courses bouEht.) Lee Mountain, Piseach, Alabama.

### Electric Supplies and Appliances

Electric Tattooing Outfits. Illustrated Catalogue. 10c. Waters Mfg., 1050 Randolph, Detroit.

### Exchange

Edison Elements for Storage B Batteries. Six to ten cents per pair postpaid. (Depending solely on size of order). A. J. Hanks, 608 Montgomery Street, Jersey City, N. J.

Amateur Agents wanted in every city and town to sell radio apparatus. A few stocking agencies still open. Delfeco, 12 Meeting Street, Pawtucket, R. I.

Sacrifice: R3 Magnavox. Used three months. Perfect condition if interested write, M. F. Jackson, Pine Apple, Ala.

For Sale New Clapp Eastham Radion Receiving Transformer F673—\$8.00. Frank Speece, Saxton, Pa.

For Sale—Aeriola Sr., with tubes \$50.00 Aeriola Sr. two stage amplifier with tubes \$50.00. Amrad short wave receiver with two stage amplifier \$30.00. Amrad two stage radio frequency set with transformers \$30.00. Mesaba Specialty Co., 310—3rd Street, South Virginia, Minn.

### Ford Owners

Sport Cars, fast, saucy, hug the turns and stick to the road—make you glad you're a Ford owner. Can easily be built by aid of life-size "Red-i-Kut" patterns and Picture Instructions. The "Pal" system delivered complete with pressed metal streamline tall for \$6.40. Garage men make big money building them. Send 5-cent coin for prospectus on making sport cars—Jifty Tops and Gosum Windshields. Kuempel Co., 315 Kuempel Bldg., Guttenberg, Iowa.

### For Inventors

Unpatented ideas can be sold. I tell you how and help you make the sale. Particulars free. Write W. A. Greene, 106 The Atlantic, Washington, D. C.

Inventors—Expert Professional service at lowest cost. Write for explanatory literature. Amon-Baxter, 2240 Ryer Avenue, New York.

### Health

Diseases and Their Innate Healer. Book 50c. Arthur J. Stevens, Wauseon, Ohio.

Tobacco or Snuff Habit Cured or no Day; \$1 if cured. Remedy sent on trial. Superba Co., S.B., Baltimore, Md.

### Insects Wanted

Get posted for Spring—Good prices paid for butterflies, insects. See Sinclair display advertisement, page 1750.

### Help Wanted

Be a Mirror Expert, \$3-\$10 a day; spare time home at first; no capital; we train, start you making and silvering mirrors. French method. Free prospectus. W. R. Derr, Pres., 26 McKinley St., Baldwin, N. Y.

Clothing Salesmen—Sell direct to consumer strongest line of \$15 to \$25 men's and young men's suits & top coats; no little sample-book proposition, but strongest line on market condensed into easy-to-carry form; liberal commissions. Write stating experience, age. Meyers Bros., Inc., 2208 Market St., Phila., Pa.

All men, women, boys, girls, 17 to 60, willing to accept Government Positions, \$117-\$190, traveling or stationary, write, Mr. Ozment, 251, St. Louis, immediately.

Get posted for Spring—Good prices paid for butterflies, insects. See Sinclair display advertisement, page 1750.

Earn \$25 Weekly, spare time, writing for newspapers, magazines. Experience unnecessary; details free. Press Syndicate, 5665, St. Louis, Mo.

### Instruction

Learn Chemistry at Home—Dr. T. O'Connor Sloane, noted educator and scientific authority, will teach you. Our home study correspondence course fits you to take a position as chemist. See our full page ad on page 1605 of this issue. Chemical Institute of New York, 140 Liberty Street, New York City.

Used Correspondence Courses only one quarter original price. Free bargain price list 1000 courses. Courses bought. Students' Exchange, 45 West 42d St., New York.

Mouth-Organ Instructor, 25c; play in one hour. Boxing Instructor, 25c. Minstrel Show Guide, 10c. Eelsea Co., Bowling Green, Ohio.

Vibrations, Lights, Colors, Sound (illustrated) Electronic Radio Active Principles. Write for table contents—242 Powell, San Francisco, Calif.

### Languages

World-Romic System. Masterkey to All Languages. Primers, 25 languages, \$1.95 each; languages: Arabic, Bohemian, Bulgarian, Cantonese, Chindau, Danish, Dutch, English, Scotch English, French, German, Hungarian, Italian, Japanese, Latin, Panjabi, Polish, Portuguese, Rumanian, Russian, Sechuana, Spanish, Swedish. Pronunciation Tables, 94 languages 30c each language. Languages Publishing Co., 8 West 40th Street, New York.

### Miscellaneous

Get posted for Spring—Good prices paid for butterflies, insects. See Sinclair display advertisement, page 1750.

Send us your Metal Work. We are equipped to do metal stamping power press work, soldering and plating, etc. Estimates furnished. T. E. Bennett Co., 7 Beverly Street, Providence, R. I.

### Motorcycles—Bicycles

Don't buy a Bicycle Motor Attachment until you get our catalog and prices. Shaw Mfg. Co., Dept. 6, Galesburg, Kansas.

Used parts for all motorcycles cheap. State wants. Schuck Cycle Company, 1922 Westlake, Seattle, Wash.

### News Correspondents

Earn \$25 Weekly, spare time, writing for newspapers, magazines. Experience unnecessary; details free. Press Syndicate, 5665, St. Louis, Mo.

### Novelties

Crystal Gazing. Book 75c. Also Crystals. Crystal Gazing Supply Co., 223 Station "B," Kansas City, Missouri.

### Office Devices

Save half on office machines, equipment, addressers, Multigraphs, Duplicators, Dictaphones. Pruitt Company, 172 North Wells, Chicago.



**Old Money Wanted**

\$2 to \$500 Each paid for hundreds of old or odd coins. Keep All Old Money, it may be very valuable. Send 10 cts. for new illustrated Coin Value Book, 4x6. Get Posted. We pay cash. Clarke Coin Company, Ave. 80, LeRoy, N. Y.

**Patents**

Inventions Commercialized. Patented or unPatented. Write Adam Fisher Mfg. Co., 278, St. Louis, Mo.

**Patent Attorneys**

Millions spent annually for ideas! Hundreds now wanted! Patent yours and profit! Write today for free books—tell how to protect yourself, how to invent, ideas wanted, how we help you sell, etc. 301 Patent Dept., American Industries, Inc., Washington, D. C.

Patents. Send drawing or model for examination and report as to patentability. Advice and booklet free. Highest references. Best results. Promptness assured. Watson F. Coleman, Patent Lawyer, 624 F Street, Washington, D. C.

Patent. Electrical cases a specialty. Pre-war charges. H. P. Fishburne, 340 McGill Bldg., Washington, D. C.

Inventors! Patents procured. Trade-marks registered. prompt personal services, fees reasonable, request free "Inventor's Guide" giving detailed information. Franklin H. Hough, Inc., 927 Washington Loan & Trust Bldg., Washington, D. C.

Herbert Jenner, Patent Attorney and Mechanical Expert. 624 F Street, Washington, D. C. I report if patent obtainable and exact cost. Send for circular.

Patents Secured. Prompt service. Avoid dangerous delays. Send for our "Record of Invention" form and Free Book telling How to Obtain a Patent. Send sketch or model for examination. Preliminary advice without charge. Highest references. Write today. J. L. Jackson & Co., 413 Ouray Bldg., Washington, D. C.

Patents—Send for form "Evidence of Conception" to be signed and witnessed. Form fee schedule, information free. Lancaster and Allwine, 269 Ouray Bldg., Washington, D. C.

Patents procured. Send sketch or model today for examination, prompt report and advice. No charge for preliminary advice. Write for free Booklet and blank form on which to disclose your idea. Highest references. Promptness assured. Clarence O'Brien, Registered Patent Lawyer, 751 Southern Building, Washington, D. C.

Inventors: Protect your Invention through A. M. Wilson, Inc., Washington, D. C. Over 25 years of efficient, expert, confidential service. Skilled in Radio-Electrical, Chemical and Mechanical fields. Our new illustrated Patent Book, giving much necessary and very useful information which every inventor should know, will be sent free upon request. Prompt and careful attention. Highest references. Moderate fees. Send sketch or model for our careful opinion and preliminary advice. Write today to A. M. Wilson, Inc., (Radio 3 AR11), 325 Victor Bldg., Washington, D. C.

Patents Procured and Trade-Marks Registered. Advice and terms upon request. Robb, Robb & Hill, 1409 Hanna Building, Cleveland, Ohio, 948 McLachlen Bldg., Washington, D. C.

Patents—Inventors should write for Free Guide Books and Record of Invention Blank before disclosing invention. Send model or sketch of your invention for our Free opinion of its patentable nature. Radio Electrical, Chemical, Mechanical and Trade-Mark experts. Victor J. Evans & Co., 922 Ninth, Washington, D. C.

**Personal**

Century Club. Exchange Post Cards and letters. Send stamp. Box 87, Copley Sq., P. O Boston, Mass.

Exchange cheery letters with new friends! Send stamp. Hetty Lee, Inc., 4254 Broadway, New York City.

**Phonographic Supplies**

Build Your Own Phonograph. Big saving. Pleasant, instructive work. Complete instructions, blue-prints, etc., absolutely free. Write today. Associated Phonograph Co., Dept. AP-13, Cincinnati, Ohio.

**Printing**

Everything Printed.—Long run specialists. Samples. Quality Printery, Marietta, Ohio.

**Scenery to Rent**

Settings for Opera, Plays, Minstrels. Plush Drops. Address Amelia Grain, Philadelphia.

**Stamps and Coins**

Stamps Free—Variety Packet Foreign Stamps with Catalogs, 2-Postage. Gray Stamp Company, Station E1, Toronto, Canada.

Stamps, 50 Varieties. Africa, Brazil, Peru, Cuba, Mexico, etc., 10c. 50 different U. S. 25c; 1,000 mixed, 40c; 1,000 hinges, 10c. List free. C. Stegman, 5956 Cote Brillante, St. Louis, Mo.

Stamps—105 China, etc., 2c. Album (500 Illustrations), 3c. Bullard 116 Tremont, Boston.

**Telegraphy**

Wanted—Young men and women to learn Morse and Wireless Telegraphy. Railroads and Wireless Companies in great need of operators. We teach you quickly, and procure positions at big salaries. Great opportunities for advancement. All expenses low; can earn part. Write today for free catalog. School established 1874. Dredges Telegraph Institute, M Street, Valparaiso, Indiana.

**Wanted to Buy**

Do You Want Extra Money—We will send you cash for any old Gold, Silver or Platinum Jewelry, and Diamonds, Silverware, discarded false teeth. Gather up the old scraps and send to us by registered mail. Highest prices guaranteed. If not satisfactory return our check and we return shipment at our expense. Meyer Jewelry Co., Suite 500 Boley Bldg., Kansas City, Mo.

Full value paid for old gold jewelry, watches, diamonds, crowns, bridges, dental gold, silver, platinum, gold or silver ore, magnetite points, war savings stamps, old false teeth. Packages held 4 to 12 days and returned if our offer is not satisfactory. United States Smelting Works (The Old Reliable), 120 So. State St., Dept. 16, Chicago, Ill.

Cash for Old Gold, Platinum, Silver, Diamonds, Lily ery Bonds, War, Thrift, Unused Postage Stamps, False Teeth, Magnetite Points, Jobs, any valuables. Mail in today. Cash sent, return mail. Goods returned in ten days if you're not satisfied. Ohio Smelting Co., 304 Hippodrome Bldg., Cleveland, Ohio.

**Wireless**

Vacuum Tube, Receiving set \$12.00. When completely equipped with "A" battery "B" battery, detector tube and double headset \$28.50. Central Mfg. Co., Fairfield, Iowa.

Variocouplers, with 14 taps and 3 in. dial \$2.00; \$25.00 DeForest sets with phones, \$12.00; 1 1/2 volt Westinghouse tubes \$3.65, tube set \$12.00; Detector unit \$1.00; 43 plate condensers with 3 in. dial \$2.50; Brandes superior phones \$6.30. Radio News back issues 40c. Max Bates, Astoria Ave. and Bay First Street, East Elmhurst, New York.

Stronberg-Carlson Phones. The professional headset at the amateur's price. Super-sensitive, comfortable, durable. Impedance correct for phone work with modern vacuum tubes. Equipped with five-foot polarity indicating, moisture-proof silk cords. A real radio headset for \$7.50. Carrollton Radio Shop, Carrollton, Missouri.

Buy a Radio receiving set on easy payments. Postal brings particulars. D & R Radio Supply Co., Fort Dodge, Iowa.

Sockets for WD-11 dry cell tubes 50c. Franklin Radio Mfg. Co., 711 Penn Ave., Wilkinsburg, Pa.

Save 20 per cent! We are closing out a complete stock of Radio Sets, parts and supplies, including Grebe, Westinghouse Clapp-Eastman and Parason. We are offering the new R.Z. Radak Set for seventy dollars. All stock is new. We will make C.O.D. Shipments on orders accompanied by certified check or money order for one fourth of price. All stock 20 per cent off Retail Price. Send Five cents for Catalog. Night Accessory Place, Rome, Georgia.

Amrad Sets. Standard Radio parts. Right prices—Try me. Jack Leech Battery Service Station, Henry, Ill.

Radio Bargains. Brandes Phones \$6.95, Red Star 2400 ohm phones \$3.90, Federal Phones \$6.95, Baldwin Phones \$10.95, 21 Plate Variable condensers \$1.70, 43 Plate condensers \$2.20, Thoradson Transformers \$3.70, Federal Transformers \$5.95. Send for complete 48 page catalog. Peerless Radio Co., 3940 Broadway, Kansas City, Mo.

Crystal Set Operators! Secure louder signals from your Crystal Detector by using a "PT" Ultra-Sensitive Contact. This wonderful Contact has received over 3,300 miles, when vacuum tubes failed. It stays adjusted; you can't knock it out with a hammer. Far superior to gold or other ordinary catwhiskers. Endorsed by authorities. Price, with instructions, twenty-five cents. "PT" Crystal Contact Company, Box 1841, Boston.

Build your own electrolyte storage battery charger. Plates and complete instructions, \$1.00. Descriptive Circular Free. Peerless Electrical Parts Co., 105 Harris Street, Rochester, N. Y.

Ten percent discount on all standard radio goods. Prompt service. Superior two step Amplifier \$25.00. QST Radio Service, Williamsport, Pa.

While they last—\$45.00 Receiving Sets including Radiotron Detector \$32.00. Two Step Amplifiers \$22.00. Loudspeakers \$12.00. Radiotron Detectors \$4.25. Amplifiers, \$5.75. Other bargains. QST Radio Service, Williamsport, Pa.

Guaranteed Repairing and Wiring—all makes of radio apparatus. We can make any set work. Write for price. Repair Dept., Radio Panel Shop, Junction City, Kansas.

Wire your Set with Copper Braid instead of solid wire. Extremely low resistance at radio frequencies. Also many mechanical advantages. No. 16 contains 96 No. 36 bare copper wires. Six feet for 25c. Radio Panel Shop, Junction City, Kansas.

For Immediate Delivery—Tubes, Magnavox, Westinghouse Receiving Sets, Phones, Condensers, Rheostats, Variometers, Couplers, Panels, Transformers, V. T. Sockets, Dials, Switch Points, and full line of parts. R. B. Electric Co., Galva, Ill.

This is Real Service—Panels cut to order, smooth saved edges. We cut them exactly to size and ship the same day your order is received. 3/4-inch thick, 1 1/2c per square inch; 5/16-inch thick, 2c 3/4-inch thick, 3c 7/16-inch thick, 3 1/2c; 1/2-inch thick, 4c; why pay more? These radio panels are made of the highest grade black fiber. This material possesses high dielectric strength, is inexpensive, unbreakable and easy to work. Our special offer, radio panels 6x8 1/4 inches, 50c; 6x12 1/4 inches, \$1. We also carry a complete stock of fiber rod and tubes, the real thing for electrical insulation, special prices quoted upon application. We pay postage. Radio Instrument & Panel Co., Box 75, Cicero, Ill.

Attention!—50 Vacuum tube hook-ups. The greatest collection of vacuum tube circuits ever brought under two covers at such insignificant cost. These diagrams will be found in the great "Rasco" catalog, which contains raw materials and parts in a greater profusion than any other catalog. Use in stamps, or coin, will bring the catalog to you. Radio Specialty Co., 96-98 Park Place, N. Y.

**Wireless—continued**

Boys! Don't Overlook This. The "Rasco" Baby Detector. Greatest detector ever brought out with molded base. Fully adjustable. See former advertisements in this publication, or our catalog. Detector with Galena Crystal, complete 50c, the same detector with Radiocite Crystal, 75c prepaid. Send for yours today. Radio Specialty Company, 96-98 Park Place, New York City.

Dials 3 inch genuine hard rubber raised or depressed scale, white or gilt lettering drilled for 1/4 and 3/8 inch shafts 60 cents each, 3 for \$1.50 postpaid. No stamps. Radio Sales Co., Box 1144, Bethlehem, Pa.

Miller audiodfrequency transformer eliminates howling. Entirely satisfactory on 3 stages. Price \$5.00 postpaid anywhere in U. S. Radio Sales Co., Box 1144, Bethlehem, Pa.

Build your own Radiophone. Instruction Book ten cents. Radio Service Institute, U. S. S. Bank Bldg., Washington, D. C.

Hundred Watt Radio Corporation Radiophone Transmitter Cheap. Unmounted. One extra hefty watt oscillator included. L. D. Stewart, Ironwood, Mich.

Power Amplifiers Magnavox 3 stage value \$110, will sell for \$81. Magnavox horns \$85 size at \$65, \$45 size for \$35. \$18. Diaphragm attachment gold mat finish fits 3/8 in. tone arm at \$12. All new apparatus. Tompkins Dry Goods Co., Middletown, N. Y.

All Radio Experimenters League Members Wear a Radio Experimenters' Lapel Button. (See cut on page 1748, this issue). Be identified as an alert and progressive radio enthusiast. Join the Radio Experimenters' League conducted by amateurs for amateurs. Any owner of a Radio set is eligible for membership. Every member receives one of these 14K gold plated lapel buttons, also a membership card and private identification code number. All members of the league are entitled to a 10 per cent discount on any approved standard receiving or transmitting radio apparatus. You may also have your choice of any one of the following: "Dopesheets" 1. Ten Super-Regenerative "Trit Diagrams" every one designed by the famous Major Armstrong himself, together with a complete discussion of their operation by Major Armstrong reprinted by special permission from the Proceedings of the Institute of Radio Engineers. 2. Diagram of Armstrong Super Receiver with accurate panel layout, list of parts and where to get them, also three photos. This set actuates valves. 3. Diagram how to make a simple and inexpensive wave-trap to separate 360 and 400 meter waves and minimize interference. 4. Wiring diagram of the best transmitting set we have seen for C. W. voice or buzzer with accurate panel layout. 5. Details of new "Reflex" circuit showing how to set two stages Radio frequency and two stages Audio frequency using only two bulbs. We always have the facts on the latest developments. If you have any hard nuts to crack or questions to ask, shoot them in; we will send a "dopesheet". We old timers are sincerely glad to lend a hand wherever possible. This is one of the most valuable features of membership. Send your name today. Enrollment and registration fee 50c, includes button, membership card, 10 per cent discount privilege, and choice of any one of the above "Dopesheets". Other "dopesheets" in the above list or special "dopesheets" answering questions, 50c each. Radio Experimenters' League, P. O. Box 1, Newark, N. J. More Radio clubs invited to affiliate. Limited number of tested W. T. 501 Peanut tubes on hand while supply lasts \$2.00 each. Sockets 40 extra—adaptors 75c extra.

15 Per Cent Discount on all makes radio apparatus and sets. Apparatus shipped C.O.D. Roger Little, Cartersburg, Indiana.

Wireless Course in 20 Lessons. By S. Gernsback, A. Lebourau and H. W. Secor, Jr., E. Tells you everything you need to know about wireless—theory, practice and history. A clear, concise course on every phase of this subject. 160 pages—350 illustrations, 30 tables. Stiff cloth cover, \$1.75, postpaid. Experimenter Publishing Co., Book Dept., 53 Park Place, New York.

How to Make Wireless Receiving Apparatus. 100 pages—80 illustrations. Only strictly modern radio apparatus are described in this book and the illustrations and descriptions are so clear and simple that no trouble will be experienced in making the instruments. Paper covered, 35c, postpaid. Experimenter Publishing Co., Book Dept., 53 Park Place, New York City.

How to Make Wireless Sending Apparatus. 100 pages—88 illustrations. Written and published entirely for the wireless enthusiast who wants to make his own radio apparatus. Contains more information on "how to make it" than any other book we know of. Paper bound 35c, postpaid. Experimenter Publishing Co., Book Dept., 53 Park Place, New York City.

The How and Why of Radio Apparatus, by H. W. Secor, E. E. This newest book on radio matters fulfills a distinct gap in wireless literature in that, while the treatment is made as understandable and as free from mathematics as possible, it at the same time incorporates a wealth of technique and instruction for the Radio Amateur—the Radio Operator—the Installation and Designing Expert—as well as teachers and students of the subject in general. A very broad field has been covered by the author, at the same time giving a great deal of information not found in other text books. If you are engaged in any branch of the Radio or allied arts at all you will surely need this latest contribution to radio literature, which is destined to be found on every radio man's book shelf before long. A glance at the following list of chapters gives but a very faint idea of the extensive and useful radio knowledge provided in its text: The Induction Coil; The Alternating Current Transformer; Radio Transmitting Condensers; The Spark Gaps; Radio-Transmitting Inductances; Radio Receiving Tuners; Radio Receiving Condensers; Detectors; Telephone Receivers; Radio Amplifiers; Construction of a Direct Reading Wavemeter and Decimeter; Antenna Construction; The Installation and Measurement of Inductances; Appendix containing very useful tables covering all subjects treated in this very unusual book. This newest of Radio Works, cloth bound in Vellum de Luxe, Gold Stamped and Hand Sewed, has 160 pages. Size of book, 6x9 inches. The How and Why of Radio Apparatus. Postpaid, \$1.75. Experimenter Publishing Co., Book Dept., 53 Park Place, New York City.

Science and Invention Bound Volume No. 9, May 1921-April 1922; contains 1200 pages with over 1500 illustrations and over 700 articles by the foremost American and Foreign writers. We have also a limited amount of the following Bound Volumes of Science and Invention (Electrical) 6-May 1918 to April 1919; Vol. No. 7—May 1919 to April 1920; Vol. No. 8—May 1920 to April 1921. Each volume bound in stiff board covered with green vellum and gold stamped. Price for volume No. 9—\$2.25. Price for volume No. 6, 7 or 8—\$2.00. All four volumes \$7.00, sent express collect. Experimenter Publishing Co., 53 Park Place, New York City.

# EVERY BOY WHO IS INTERESTED IN RADIO

## CAN TAKE ADVANTAGE OF OUR SPECIAL OFFER

EVERY BOY HAS A FEW SPARE HOURS EACH WEEK and can easily obtain a few subscribers to PRACTICAL ELECTRICS.

On this page you will see the special rewards we will send you for only one subscription. You can easily earn every one of them. They will be sent you

### ABSOLUTELY FREE

PRACTICAL ELECTRICS is the electrical magazine for everyone. It is the only electrical magazine a boy can understand. It has a regular department for beginners, but is just as interesting for the experimenter, the electrician, and the electrical engineer. There are articles each month by students, experimenters and famous electricians. The entire progress of the month in electrics is set forth in its pages.

PRACTICAL ELECTRICS is one of the most interesting electrical magazines published. It contains no long, dry technical articles. Every article is completely illustrated. There are hundreds of illustrations, plans, drawings, charts, etc.

On the opposite page you will find complete description of each reward.

**PRACTICAL ELECTRICS is only \$2.00 per year [12 Numbers]**

(Canada or foreign 50 cents additional)

**EVERY BOY SHOULD HAVE IT!**

All articles are written in plain, everyday language. If you need a sample copy to show we will send it free of cost.

**SEE OPPOSITE PAGE FOR DESCRIPTIONS**

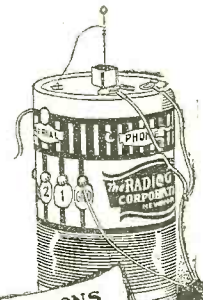

# OH BOYS!

**ABSOLUTELY FREE FOR A FEW HOURS' SPARE TIME WORK. READ OUR SPECIAL OFFER AND ACT AT ONCE.**



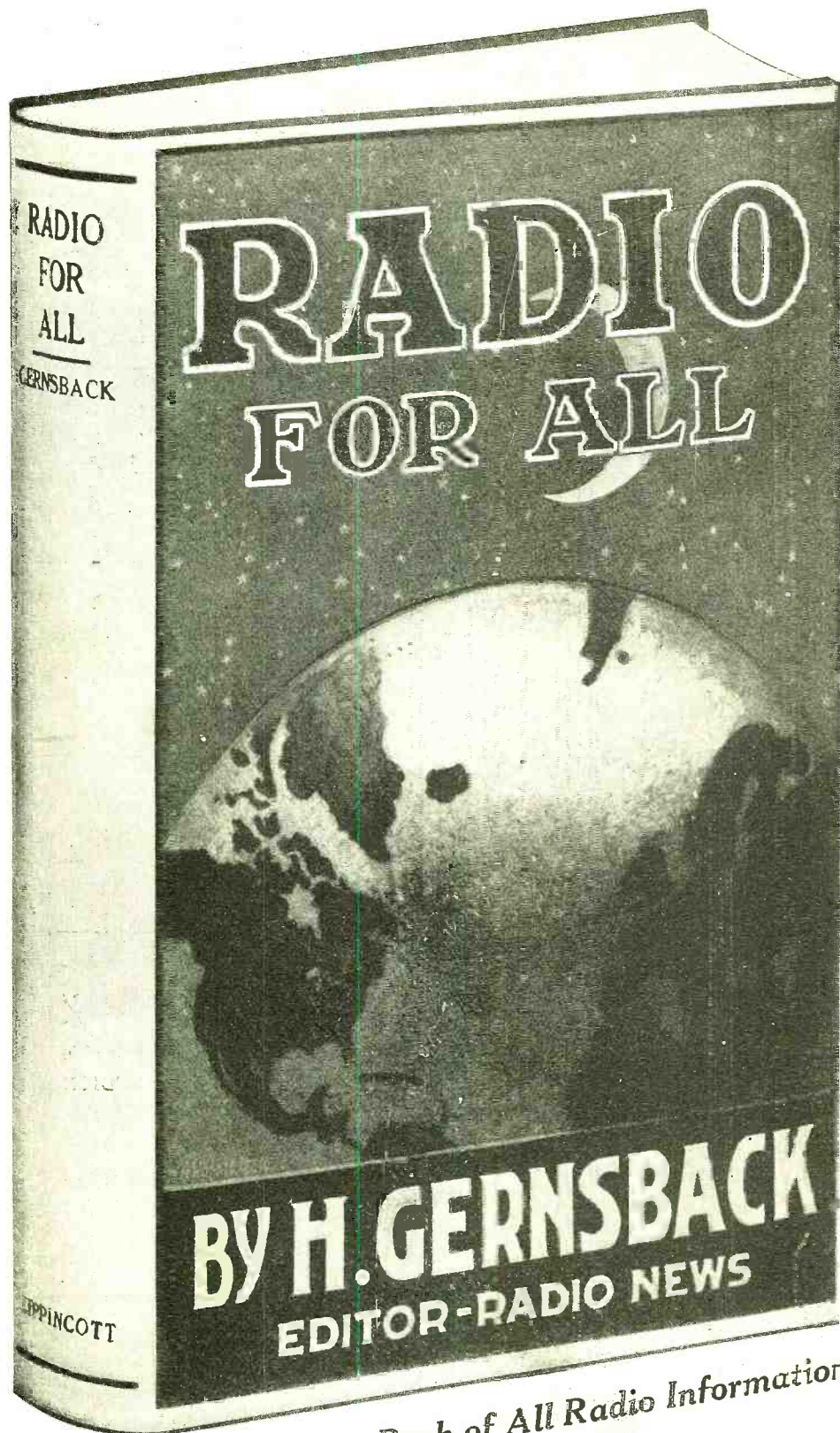

*The Complete Book of All Radio Information*

**PRICE POSTPAID \$2.00**

*Make all remittances payable to and mail to*  
**EXPERIMENTER PUBLISHING CO., Inc.**  
 53 Park Place :- New York, N. Y.

# RADIO FOR ALL

**By H. GERNSBACK**

Editor "Radio News," "Science and Invention" and "Practical Electrician"

With over 130 illustrations and diagrams, and 12 photographs, 300 pages, size 8 1/4 x 5 1/2".

What the novice in radio needs is a book in which he can get all the information necessary for him to understand radio telephony and telegraphy, to make or buy a receiving set suitable to his means, to know how to operate his set, and, after he has an understanding of the radio art, information that will enable him to advance and get the most out of his outfit. All this must ordinarily be dug out of text-books, pamphlets and government publications, but the aim of this book is to have all the data and information that the beginner will need from the time that he takes up radio. It is a permanent, comprehensive reference book for the dyed-in-the-wool dabbler in Radio.

## WHAT THE BOOK IS.

A combination of a radio course for the novice in radio telegraphy and telephony with a reference book for the more experienced amateur. Half a dozen books in one.

## FOR THE BEGINNER.

- The theory of radio carefully explained with drawings.
- Description of and instruction for operating instruments of receiving and sending sets, with all picture diagrams of the wiring of the apparatus.
- How to make your own receiving set, costing from \$3.00 to \$50.00.
- How to read diagrams; for every picture diagram there is a corresponding technical diagram using the symbols instead of drawings.
- How to tune sharply and eliminate interference from other stations.
- How to protect your set from lightning, and the laws regarding installation.
- Explanation of time and weather signals.

## FOR THE MORE EXPERIENCED AMATEUR.

- How to make a practical vacuum tube detector, two stage amplifier set costing less than \$50.00, that will work.
- How the radio compass works.
- All about underground aeriels, loop aeriels and directional aeriels.
- Formulae for finding wave length; miscellaneous formulae for finding capacity of condenser and other instruments.
- Tables of wire resistances, wave lengths and their corresponding frequencies, approximate wave lengths for different aeriels, tuning coil data, and much more invaluable information.

## SPECIAL FEATURES.

- Lists of all the broadcasting stations in the United States and Canada for concerts, time signals, weather reports, press, stock market reports, etc., with their call, wave length and time of sending.
- Detailed description of Washington weather signals and their translation.
- Description of a modern broadcasting station and its operation.
- Large map showing location of all U. S. radio telephone broadcasting stations suitable for hanging up in radio room.
- Collection of miscellaneous radio information for the amateur.

## IN OTHER WORDS.

The information that you ordinarily have to dig out of government publications, text-books, pamphlets, etc., is handily combined in this one book.

Get This Wonderful New Book About

# LOUD - TALKERS

## HOW TO BUILD THEM

by H. WINFIELD SECOR

Associate Editor of Science & Invention

25 cents postpaid

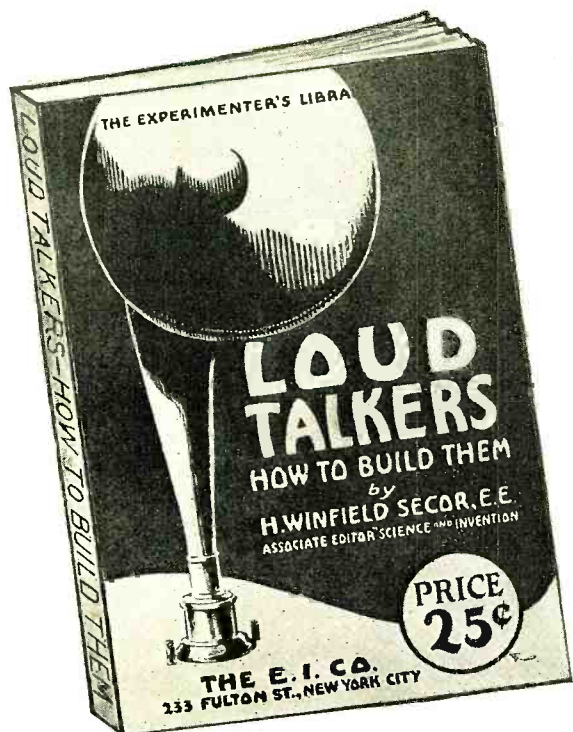

This book describes how to build two distinct and different types of radio loud-talkers, which can be built with either electro-magnetic field to be excited from storage battery, as well as permanent magnet field requiring no separate battery excitation. The third chapter deals with improvised loud-talkers and gives clear and complete instructions on how to build suitable horns for use with radio receivers of the Baldwin and other types. Several elaborate hook-ups are given of the author's own radio receiving set, comprising one stage of radio-frequency, detector and three stages of audio-frequency amplification, together with all the connections for the loud-talker.

Complete data is given for all the parts of the loud-talkers, including the field magnet windings, as well as the diaphragm or moving coil windings, and also the step-down transformer to be connected between the vacuum tube amplifier and the loud-talker proper.

In preparing these designs the point has been constantly kept in mind to use the simplest parts possible, so that practically anyone can build a successful loud-talker equivalent to the commercial types costing \$40.00 or more.

Even where the experimenter does not possess the skill or the time to make all the parts himself, which are really few in number, he may save a great deal of money, or at least half the price of a commercial loud-talker, by having the difficult parts made in a local machine shop, and then assembling them and winding the coils himself. Circuit connections and data for the size of wire, etc., are given for placing the loud-talker on a separate floor or in another part of the house not occupied by the radio receiving set. A very valuable book, giving data which cannot be obtained anywhere else and which has not been published before.

64 pages, 25 illustrations, bound in beautiful two-color cover, size 5½ x 7½ inches; Price prepaid, 25 cents

## Have You a Copy of These Two Books?

### HOW TO MAKE RADIO-PHONE RECEIVING SETS

By ROBERT E. LACAULT  
Associate Editor RADIO NEWS

25c

### RADIO FREQUENCY AMPLIFIERS

AND HOW TO MAKE THEM

By JOHN M. AVERY

25c

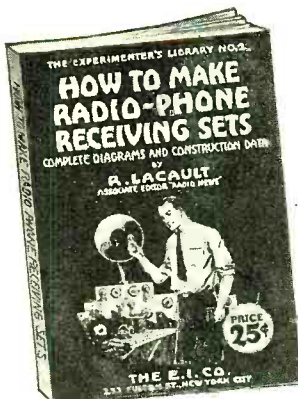

A non-technical book for the beginner. Gives complete constructional data on the building of a complete Crystal Detector Set, Tuning Coil, Loose Coupler and a Single Audion Tube Set with Amplifying Units. It furnishes all dimensions and working drawings of every part that must be constructed by the amateur. Written in plain, simple language that anyone can understand. The opening chapter gives a complete description of the theory of radio and tells what it's all about, teaching the principles of wireless so that the constructor knows what he is doing.

48 pages, 26 illustrations  
Bound in Beautiful Two-Color Cover  
Size, 5½x7½ in. Prepaid 25c.

This book is for the more advanced amateur, showing the construction of the Radio Frequency Amplifying Transformer and giving complete constructional data. It shows the application of Radio Frequency to amplifying units that the amateur may already possess and gives 15 hook-ups showing practically every use Radio Frequency Amplifying Transformers can be put to.

32 Pages, 15 illustrations  
Bound in Beautiful Two-Color Cover  
Size, 5½x7½ in. Prepaid, 25c.

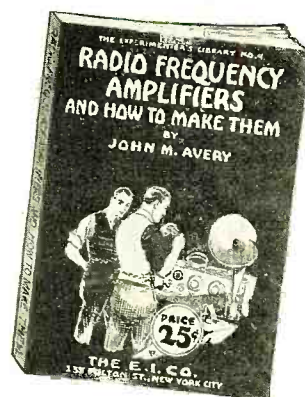

Order from your dealer—or direct from us

THE E. I. COMPANY NEW YORK CITY, N. Y. 233 FULTON STREET

# Two Supreme Achievements in Radiolas

## Radiola Grand

TRADE MARK REG. U. S. PAT. OFF.



RADIOLA GRAND and Mahogany Stand with "B" Batteries, tubes and full instructions, \$350.00

The finest principles of radio detection, amplification and loud speaking are embodied in the new RADIOLA GRAND.

The RADIOLA GRAND has been especially designed to receive broadcasting stations operating on the standard wave lengths of 360 and 400 meters, but an additional range is available up to 550 meters. By means of a new type of Loud Speaker, the entire family may receive broadcasted music and other entertainment and instruction.

A telephone jack is provided in order that head telephones may be employed for the reception of broadcasting over great distances.

## Radiola IV

TRADE MARK REG. U. S. PAT. OFF.

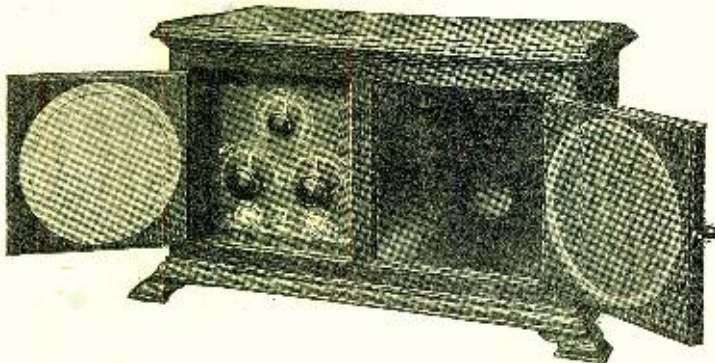

RADIOLA IV, complete with 4 tubes (1 spare), all batteries, headset with telephone plug and silk covered leads for antenna and ground, \$275.00

RADIOLA IV is a self contained console-type broadcast receiver. The cabinet contains a regenerative receiver, a detector, two stages of audio frequency amplification, a new loud speaker of unsurpassed tone quality and all necessary batteries.

RADIOLA IV is not only a highly efficient receiver, embodying the latest developments in design, but is also a thing of beauty that will grace a drawing room or library.

Both of these Radiolas provide exceptional long distance as well as local reception.

Ask your nearest dealer to show you the Radiola line.

*"There's a Radiola for every purse"*



This symbol of quality is your protection

# Radio Corporation of America

Sales Department, Suite 2065  
233 Broadway  
New York

District Offices  
10 So. La Salle Street  
Chicago, Ill.

433 California Street  
San Francisco, Cal.